

# GROVE®

# GMK5165

## product guide

### features

- 42-197 ft. (12.9-60 m) 6-section full power boom
- Patented TWIN-LOCK™ boom pinning system
- 36-59 ft. (11-18 m) bifold lattice swingaway, hydraulic luffing or manual offset
- 88,400 lb. (40 000 kg) counterweight with hydraulic removal system
- 510 hp (380 kW) Mercedes OM 502 LA 8 cylinder turbo-charged diesel engine. Daimler Chrysler, 16 speed G240-16 transmission
- Independent hydro-pneumatic MEGATRAK™ suspension
- All wheel steering

### contents

Features	2
Specifications	3
Dimensions	5
Counterweight Dimensions	6
Travel Proposal	7
Working Range Main Boom	8
Main Boom Charts	9
Load Charts	10
Working Range Manual Offset Swingaway	11
Working Range Hydraulic Offset Swingaway	12
Hydraulic Offset Swingaway Charts	13
Manual Offset Swingaway Charts	14



All Terrain Crane

# features

2



Mercedes-Benz OM 502 LA  
510 bhp (380 kW) @ 1800 rpm  
1770 ft./lb. torque (2400 Nm) @ 1200 rpm

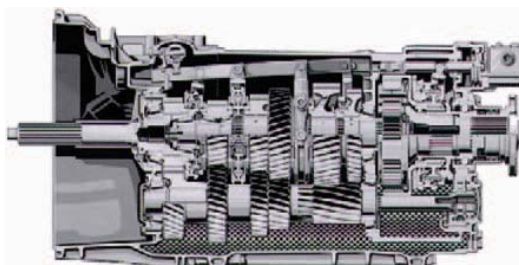

Daimler Chrysler  
16 speed G240-16

TWIN-LOCK™  
Boom pinning  
mechanism  
automatically pins  
the sections in  
position using two  
horizontal large  
diameter boom  
pins

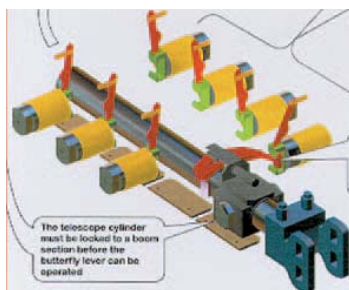

MEGATRAK™  
Independent  
suspension and  
all wheel steer  
system allows  
wheels to  
remain on the  
ground at all  
times so  
stresses and  
weight are not  
continually  
transferred  
between axles

LUFFING BI-FOLD SWINGAWAY  
Hydraulically offset lattice bi-fold swingaway  
lets the operator set the offset from 0°-40°  
while under load, from the superstructure  
cab

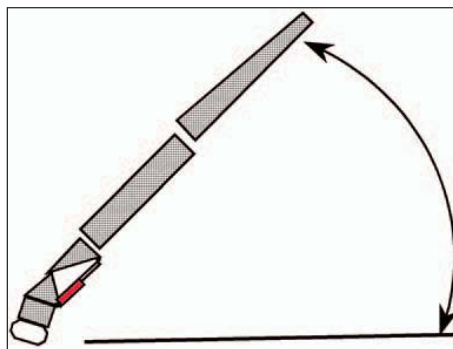

# specifications

## Superstructure

### Boom

42 ft. - 197 ft. (12.9 m - 60 m) six section, full power boom with patented TWIN-LOCK™ boom pinning system. Maximum tip height: 207 ft. (63 m).

### Boom Nose

Eight nylatron sheaves, mounted on heavy duty tapered roller bearings with removable pin-type rope guards. Quick reeve boom nose. Removable auxiliary boom nose with removable pin type rope guard.

### Boom Elevation

Single lift cylinder with safety valve provides boom angle from -3° to +83°.

### Hydraulically Offsettable Lattice Extension

36 ft. - 59 ft. (11 m - 18 m) bifold lattice swingaway extension **hydraulically offsettable** and luffing under load: 0° - 40°. Controlled from the crane cab. Maximum tip height: 266 ft. (81 m)

### \* Offsettable Lattice Extension

36 ft. - 59 ft. (11 m - 18 m) bifold lattice swingaway extension manually offset: 0°, 20° or 40°. Maximum tip height: 266 ft. (81 m)

### Lattice Extension Inserts

One 26 ft. (8 m) and one 20 ft. (6 m) insert for use with lattice swingaway extension. Increases extension length to 85 ft. (26 m) or 105 ft. (32 m).

### Load Moment & Anti-Two Block System

Load moment and anti-two block system with audio/visual warning and control lever lockout provides electronic display of boom angle, length, radius, tip height, relative load moment, maximum permissible load, load indication and warning of impending two-block condition.

### Cab

All aluminum construction cab with acoustical lining, tinted safety glass, adjustable operator's seat with hydraulic suspension, opening windows in side and cab rear, hinged front window with wiper, sunvisor and window shade. Other features include hot water heater, armrest integrated crane controls, and ergonomically arranged instrumentation.

### Crane Control System

Full electronic control of all crane movements using electrical control levers with automatic reset to zero. Controls are integrated with the LMI and engine management system by CAN-BUS. ECOS system with graphic display.

### Swing

Two planetary gears with axial piston motors. Infinitely variable to 1.7 rpm. Holding and service brake.

### Counterweight

88,400 lbs. (40 000 kg) consisting of various sections with hydraulic installation/removal system. Controlled from the superstructure cab.

### Engine

Mercedes-Benz OM 904 LA diesel, 4 cylinders, water cooled, turbocharged with 174 bhp (130 kW) @ 2200 rpm. Max torque: 498 ft/lb. (675 Nm) at 100 rpm. Engine emission: EUROMOT/EPA/CARB (non road).

### Hydraulic System

2 separate circuits, 1 axial piston variable displacement pump (load sensing) with electronic power limiting control and 1 gear pump for swing. Dual thermostatically controlled oil coolers keep oil at optimum operating temperature. Tank capacity: 211 gal. (800 l)

### Hoist

Main and auxiliary hoists are powered by axial piston motor with planetary gear and brake. "Thumb-thumper" hoist drum rotation indicator alerts operator of hoist movement.

	Main	Auxiliary
Line length:	837 ft. (255 m)	591 ft. (180 m)
Rope diameter:	19 mm	19 mm
Line speed:	394 ft./min. (120 m/min)	394 ft./min. (120 m/min)
Line pull:	15,700 lbs. (70 kN)	15,700 lbs. (70 kN)

### Electrical System

24V system with three phase alternator, 28V/80A. 2 batteries, 12V/170 Ah.

### \*Optional Equipment

- \*Work light, mounted on top of base section.
- \*Cab controlled work lights mounted to top of base section.
- \*Stainless steel exhaust system with spark arrestor in lieu of standard.
- \*Engine independent diesel cab heater, also serves as engine preheater.
- \*24 hr. timer for diesel preheater.
- \*Engine independent propane gas cab heater.
- \*Stereo/radio CD player.
- \*Outrigger pad load indicator with readout both in superstructure cab and carrier.
- \*Air conditioning.
- \*Data Logger (Superstructure Only).
- \*Working range limiter.
- \*Boom mounted aircraft warning light.

\*Denotes optional equipment

3

**GMK5165**

**GROVE**



# specifications

4

## Carrier

### Chassis

Box type, torsion resistant frame is fabricated from high strength steel.

### Outrigger System

Four hydraulic single stage outrigger beams with vertical cylinders and outrigger pads, 23.6" (600 mm) square. Outriggers can be set in 3 positions:

Full	- 24.6' (7.5 m)
Partial	- 16.7' (5.1 m)
Retracted	- 8.2' (2.5 m)

Independent horizontal and vertical movement controlled from each side of carrier. Electronic crane level indicators.

### Engine

Mercedes-Benz OM 502 LA eight cylinder, water cooled, turbo-charged, with 510 bhp (380 kW) @ 1800 rpm. Max. torque 1,770 ft./lb. (2 400 Nm) @ 1200 rpm.

Engine emissions: EUROMOT/EPA/CARB (off road)

Compression and exhaust brakes.

### Fuel Tank Capacity

106 gallons (400 L).

### Transmission

Daimler Chrysler, 16 speed G240-16.

### Drive/Steer

10X8X10

### Axles

1st axle line – steer

2nd axle line – steer (additional drive)

3rd axle line – drive/steer (disconnects for highway travel 10x8x10 drive only)

4th axle line – drive/steer (connects for all wheel steer)

5th axle line – drive/steer

Drive axles with planetary hub reduction and center mounted differential-gearing. Inter-axle and cross axle differential locks.

### Suspension

Exclusive MEGATRAK suspension. Independent hydro-pneumatic system acting on all wheels with hydraulic lockout. Suspension can be raised 6.5" (170 mm) or lowered 5" (130 mm) both longitudinally and transversely. Features an automatic leveling system for highway travel.

### Tires

10 tires, 20.5R25

### Steering

Dual circuit, hydraulic power assisted steering system. Transfer case mounted, ground driven emergency steering pump. Axles 1, 2, 3 and 5 steer on highway. Separate steering of the 4th and 5th axles for all wheel and crab steering, controlled by an electronic rocker switch.

### Brakes

Service brakes: pneumatic dual circuit acting on all wheels, anti lock prevention.

Parking brake: pneumatically operated spring loaded brake acting on axle lines 2 and 5.

Air dryer.

### Cab

Two-man, aluminum construction with the following features: safety glass, driver and passenger seats with hydraulic suspension, heated rear view mirrors, hot water heater, complete instrumentation and driving controls.

### Electrical System

24V system with three phase alternator, 28V/100A  
2 batteries, 12V/170 Ah

### Maximum Speed

53 mph (85 kph)

### Gradeability (Theoretical)

72% - 14.00 tires

64% - 16.00/20.5 tires

## Miscellaneous Standard Equipment

Work light; tool kit; fire extinguisher; auxiliary boom nose; radio/CD player in carrier cab, heated rear view mirrors, and cruise control.

## Optional Equipment

\*Stainless steel exhaust system with spark arrestor

\*Air conditioning

\*16.00R25 tires (vehicle width 9.8 ft., 3 m)

\*10X6X10 drive/steer

\*Electric driveline retarder

\*Engine independent diesel cab heater, with engine pre-heater

\*24 hr. timer for diesel preheater

\*Engine independent propane gas cab heater

\*Worklights for outriggers

\*Steel outrigger floats

\*Data Logger (Carrier Only)

\*Spare tire with carry bracket

\*Denotes optional equipment

GMK5165

GROVE.



# dimensions

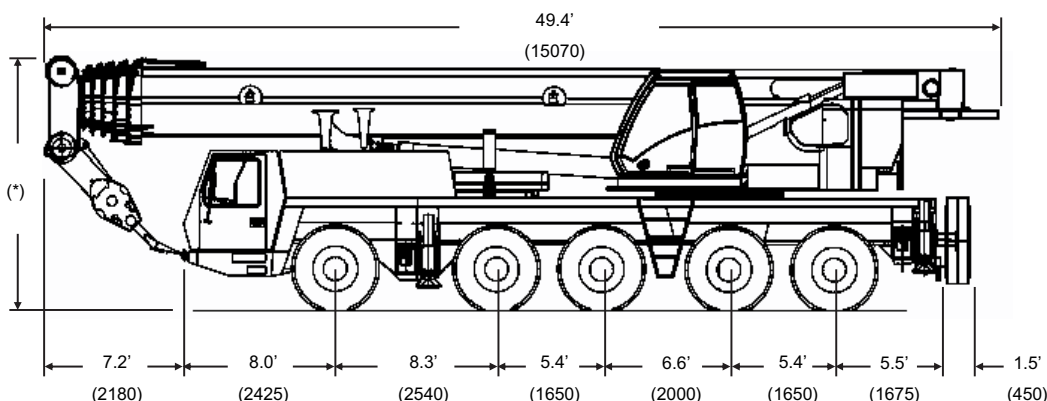

5

(\*) Travel Height +6.7'/-5.1" (+170/-130)  
 14.00 Tires – 13' (3 950)  
 16.00/20.5 Tires – 13.2' (4 023)

Basic Weights - lb. (kg.)	Axles 1-3		Axles 4 & 5		Total	
Mercedes power, 20.5R25 tires, 10X6X10 drive/steer, 2nd oil cooler, outrigger pads, auxiliary hoist and driver.	66,528	(30 177)	43,415	(19 693)	109,943	(49 870)
<b>Additions:</b>						
10X8X10 drive /steer	772	(350)	22	(10)	794	(360)
Electric driveline retarder	-66	(-30)	727	(330)	661	(300)
14.00R25 spare tire with bracket	-340	(-154)	924	(419)	584	(265)
16.00R25 spare tire with bracket	-423	(-192)	1,140	(517)	715	(325)
20.5R25 spare tire with bracket	-487	(-221)	1,296	(588)	809	(367)
Brackets for swingaway	183	(83)	71	(32)	254	(115)
Hose reel for luffing swingaway	523	(237)	-203	(-92)	320	(145)
36 ft. - 56 ft. (11 m - 18 m) swingaway	3,982	(1 806)	-829	(-376)	3,153	(1 430)
Auxiliary boom nose	364	(165)	-209	(-95)	154	(70)
5,500 lb. (2 500 kg.) section 8 pinned to superstructure	-3,045	(-1 381)	8,556	(3 881)	5,512	(2 500)
5,500 lb. (2 500 kg.) section 1 stowed on carrier	5,020	(2 277)	205	(93)	5,225	(2 370)
<b>Substitutions</b>						
14.00R25 tires	-1,349	(-612)	-900	(-408)	-2,249	(-1 020)
16.00R25 tires	-555	(-252)	-371	(-168)	-926	(-420)
<b>Removals:</b>						
Boom assembly	-32,522	(-14 752)	-1,076	(-488)	-33,598	(-15 240)
Front outriggers	-3,757	(-1 704)	626	(284)	-3,131	(-1 420)
Rear outriggers	1,437	(652)	-4,744	(-2 152)	-3,307	(-1 500)
Front and rear outrigger floats	-168	(-76)	-273	(-124)	-441	(-200)

**GMK5165**

**GROVE**



# counterweight

6

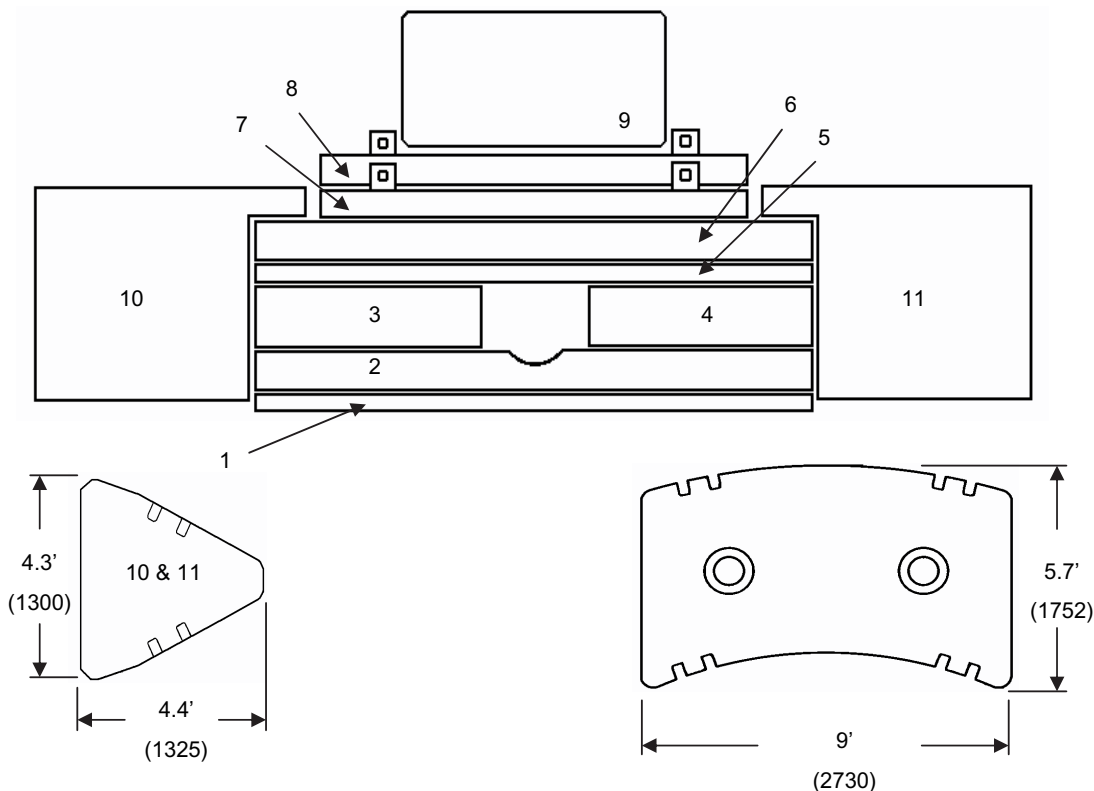

- |                                   |   |
|-----------------------------------|---|
| 1. 5,500 lb.(2 500 kg.) Baseplate | 7. 5,500 lb.(2 500 kg.) Pinned                          |
| 2. 11,000 lb.(5 000 kg.) Stacking | 8. 5,500 lb.(2 500 kg.) Pinned                          |
| 3. 8 300 lb.(3 750 kg.) Stacking  | 9. 2,200 lb.(1 000 kg.) Bolted (Auxiliary Hoist or IPO) |
| 4. 8,300 lb.(3 750 kg.) Stacking  | 10. 12,700 lb.(5 770 kg.) Wing                          |
| 5. 5,500 lb.(2 500 kg.) Stacking  | 11. 12,700 lb.(5 770 kg.) Wing                          |
| 6. 11,000 lb.(5 000 kg.) Stacking |   |

	1	2	3	4	5	6	7	8	9	10	11
Counterweight Configuration lb.(kg.)											
2,200 (1 000)									•		
7,700 (3 500)								•	•		
13,200 (6 000)							•	•	•		
18,700 (8 500)	•						•	•	•		
24,200 (11 000)	•		•	•					•		
29,700 (13 500)	•		•	•				•	•		
35,200 (16 000)	•		•	•			•	•	•		
40,700 (18 500)	•	•	•	•				•	•		
46,200 (21 000)	•	•	•	•			•	•	•		
51,800 (23 500)	•	•	•	•	•		•	•	•		
57,300 (26 000)	•	•	•	•		•	•	•	•		
62,800 (28 500)	•	•	•	•	•	•	•	•	•		
88,400 (40 100)	•	•	•	•	•	•	•	•	•	•	•

**GMK5165**

**GROVE**



# trailing boom proposal

## Trailing Boom

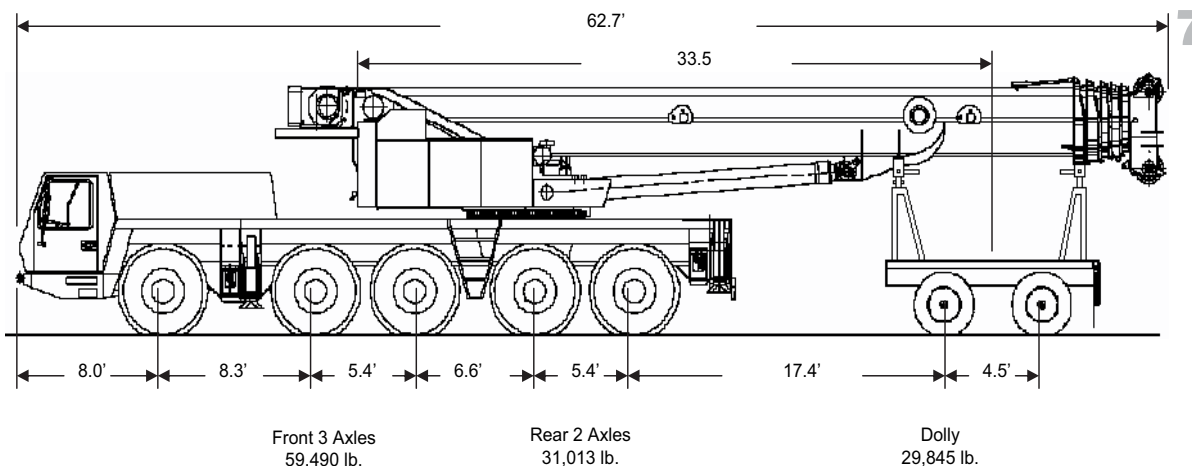

### Unit Configuration:

- 42' – 197' boom
- Outrigger pads stowed on unit
- 10 X 8 X 10 drive/steer
- Main and auxiliary hoists with cable
- 36 – 59 ft. hydraulic luffing swingaway
- Additional oil cooler
- 20.5 tires
- 2 axle boom dolly (5,700 lb.)

**GMK5165**

**GROVE**



# working range

## 42'-197' main boom

8

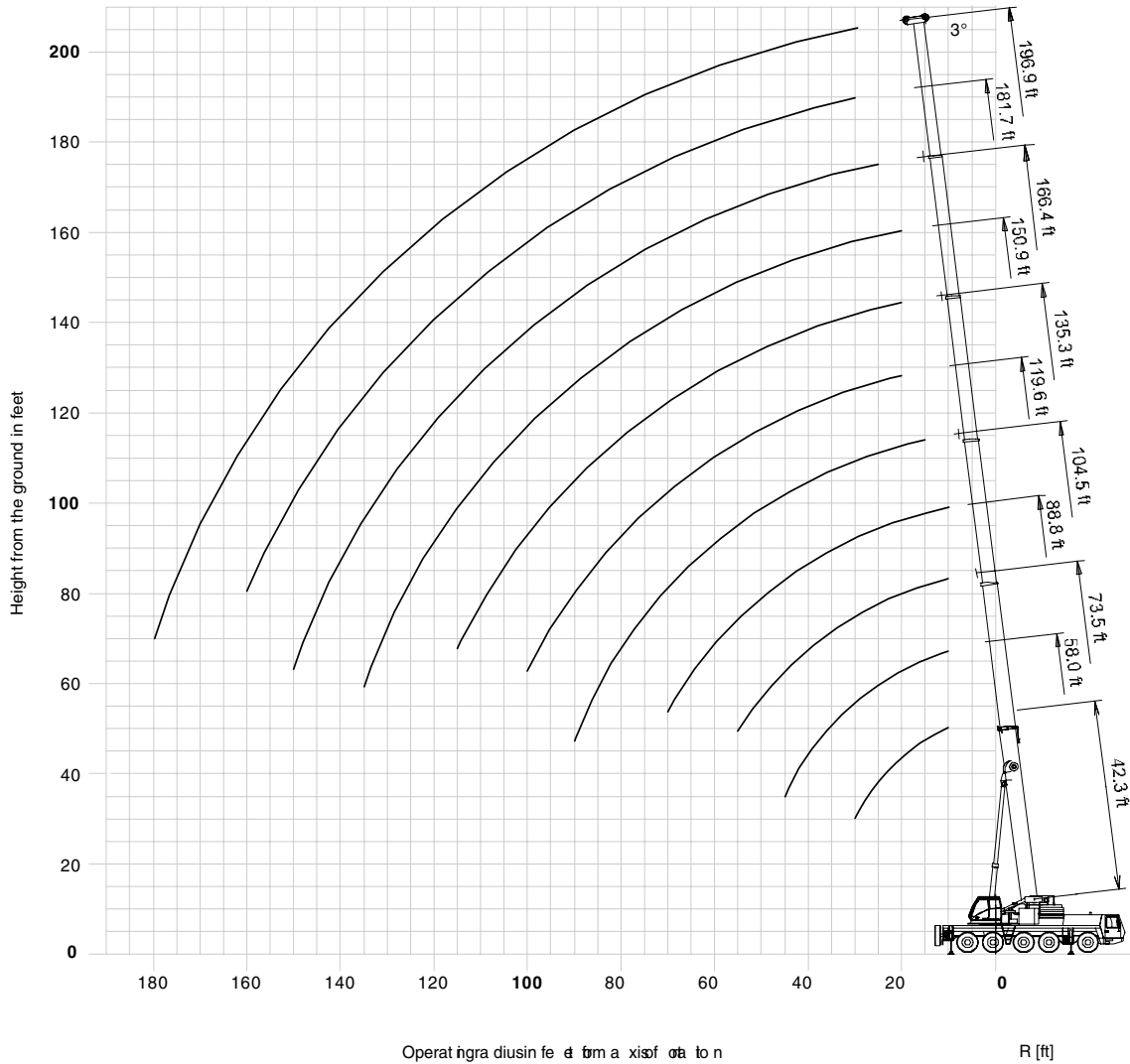





**GMK5165**



THIS CHART IS ONLY A GUIDE AND SHOULD NOT BE USED TO OPERATE THE CRANE. The individual crane's load chart, operating instructions and other instructional plates must be read and understood prior to operating the crane.

**GROVE**



# load charts





 42-197 ft. (12.8-60.0 m)
  88,400 lb. (40,100 kg)
  100% 247" Spread
  360°



 Pounds (thousands)

9

Feet	42'	58'	73'	89'	104'	119'	135'	150'	166'	181'	197'
8	*240.0										
10	215.0	199.0	186.0	143.0							
15	168.0	165.0	154.0	143.0	110.0						
20	136.0	137.0	132.0	125.0	108.0	84.0	62.0	45.0			
25	113.0	114.0	114.0	110.0	98.0	78.0	62.0	45.0			
30	92.0	97.0	96.0	95.0	90.0	72.0	61.0	45.0	35.2	25.6	22.0
35		83.0	83.0	82.0	82.0	66.0	56.0	45.0	35.2	25.6	22.0
40		72.0	72.0	71.0	72.0	60.0	51.0	45.0	35.2	25.6	22.0
45		61.0	64.0	62.0	61.0	56.0	47.0	41.4	35.2	25.6	22.0
50			56.0	56.0	53.0	52.0	42.6	38.4	34.8	25.6	22.0
55			48.0	50.0	47.0	47.0	39.2	35.6	32.4	25.6	22.0
60				43.4	41.4	42.2	35.8	32.8	29.8	25.6	22.0
65				38.2	37.6	37.8	32.6	29.8	27.8	25.6	22.0
70				34.0	35.4	34.0	30.2	27.4	25.8	24.4	21.6
75				27.2	32.0	30.8	28.0	25.4	24.0	23.0	20.6
80					29.0	27.6	26.4	23.8	22.2	21.4	19.6
85					26.2	24.8	25.2	22.0	20.8	20.0	18.6
90					23.8	22.4	23.8	20.8	19.4	18.8	17.8
95						21.0	21.6	19.0	18.2	17.6	17.0
100						20.0	19.6	17.0	17.0	16.4	16.0
105							18.0	15.8	15.6	15.0	14.8
110							16.4	14.8	14.2	13.8	13.6
115							15.0	14.0	12.8	12.8	12.8
120								13.4	11.6	12.0	12.0
125								12.8	10.4	11.6	11.4
130								12.2	9.8	11.0	10.8
135								11.2	9.4	10.4	10.0
140									8.8	10.0	9.0
145									8.4	9.2	8.2
150									8.0	8.4	7.4
155										7.8	6.8
160										7.0	6.0
165											5.4
170											4.8
175											4.4
180											3.8

\*Over rear

 42-197 ft. (12.8-60.0 m)
  46,200 lb. (21,000 kg)
  100% 247" Spread
  360°

 Pounds (thousands)

Feet	42'	58'	73'	89'	104'	119'	135'	150'	166'	181'	197'
10	210.0	199.0	186.0	143.0							
15	164.0	163.0	154.0	143.0	110.0						
20	131.0	132.0	131.0	124.0	108.0	84.0	62.0	45.0			
25	107.0	108.0	101.0	93.0	89.0	78.0	62.0	45.0	35.2		
30	85.0	85.0	78.0	76.0	70.0	69.0	61.0	45.0	35.2	25.6	22.0
35		68.0	65.0	62.0	61.0	57.0	53.0	45.0	35.2	25.6	22.0
40		55.0	54.0	51.0	51.0	48.0	44.0	42.8	35.2	25.6	22.0
45		46.0	46.0	45.0	43.8	40.6	41.0	36.4	35.2	25.6	22.0
50			40.0	40.2	37.8	35.6	35.6	31.2	30.6	25.6	22.0
55			34.8	35.2	33.0	32.8	31.0	28.2	26.6	25.6	22.0
60				30.6	29.0	29.8	27.4	26.4	23.2	23.8	22.0
65				26.6	25.8	26.4	24.2	24.4	21.6	22.4	21.0
70				23.4	22.6	23.8	21.6	21.8	20.2	20.4	18.8
75				15.0	19.8	21.4	19.2	19.4	19.0	18.2	16.6
80					17.6	19.0	17.2	17.6	17.8	16.4	14.8
85					15.4	16.8	15.4	15.8	16.0	14.8	13.2
90					13.8	15.0	13.8	14.2	14.4	13.2	11.8
95						13.6	12.2	13.2	13.2	11.8	10.4
100						12.8	11.0	12.4	11.8	10.8	9.4
105							10.4	11.4	10.8	9.6	8.2
110							9.8	10.4	9.8	8.6	7.2
115							9.2	9.2	8.6	7.8	6.4
120							8.4	8.4	7.8	7.0	5.6
125							7.6	7.6	6.8	6.0	4.8
130							6.8	6.8	6.0	5.4	4.2
135							6.0	6.0	5.4	4.6	3.6
140								4.8	4.8	4.0	3.0
145								4.0	4.0	3.4	2.4
150									3.6	2.8	
155										2.2	





THIS CHART IS ONLY A GUIDE AND SHOULD NOT BE USED TO OPERATE THE CRANE. The individual crane's load chart, operating instructions and other instructional plates must be read and understood prior to operating the crane.

**GMK5165**

**GROVE**

# load charts

10

-   
42-197 ft.  
(12.8-60.0 m)
-   
2,200 lb.  
(1000 kg)
-   
100%  
24'7" Spread
-   
360°

Feet	42'	58'	73'	89'	104'	119'	135'	150'	166'	181'	197'
10	205.0	199.0	186.0	143.0							
15	153.0	141.0	123.0	113.0	99.0						
20	93.0	87.0	81.0	78.0	71.0	64.0	58.0	45.0			
25	64.0	63.0	61.0	57.0	53.0	52.0	47.0	41.8	35.2		
30	46.0	47.0	46.0	43.8	40.2	40.0	36.0	36.2	29.8	25.6	22.0
35		36.2	36.6	36.4	31.8	33.8	31.8	29.8	27.6	24.2	22.0
40		28.4	29.2	29.4	28.4	27.6	26.0	24.4	22.4	20.4	18.2
45		22.0	23.8	24.2	23.8	22.8	21.6	20.2	18.6	16.8	14.8
50			19.6	20.2	19.8	19.2	18.2	16.8	15.4	13.8	12.0
55			16.0	17.0	16.8	16.2	15.4	14.2	13.0	11.4	9.6
60				14.4	14.2	13.8	13.0	12.0	10.8	9.4	7.8
65				12.0	12.2	11.8	11.0	10.0	9.0	7.6	6.2
70					10.4	10.2	9.4	8.4	7.4	6.2	4.6
75					8.8	8.6	8.0	7.2	6.2	4.8	3.4
80					7.4	7.4	6.8	6.0	5.0	3.8	2.4
85					6.0	6.2	5.6	4.8	4.0	2.8	
90					5.0	5.2	4.6	4.0	3.0		
95						4.2	3.8	3.0	2.2		
100							3.4	3.0	2.4		
105								2.2			

**GMK5165**

THIS CHART IS ONLY A GUIDE AND SHOULD NOT BE USED TO OPERATE THE CRANE. The individual crane's load chart, operating instructions and other instructional plates must be read and understood prior to operating the crane.

**GROVE**



# working range

manual offset swingaway

## 42'-197' main boom

11

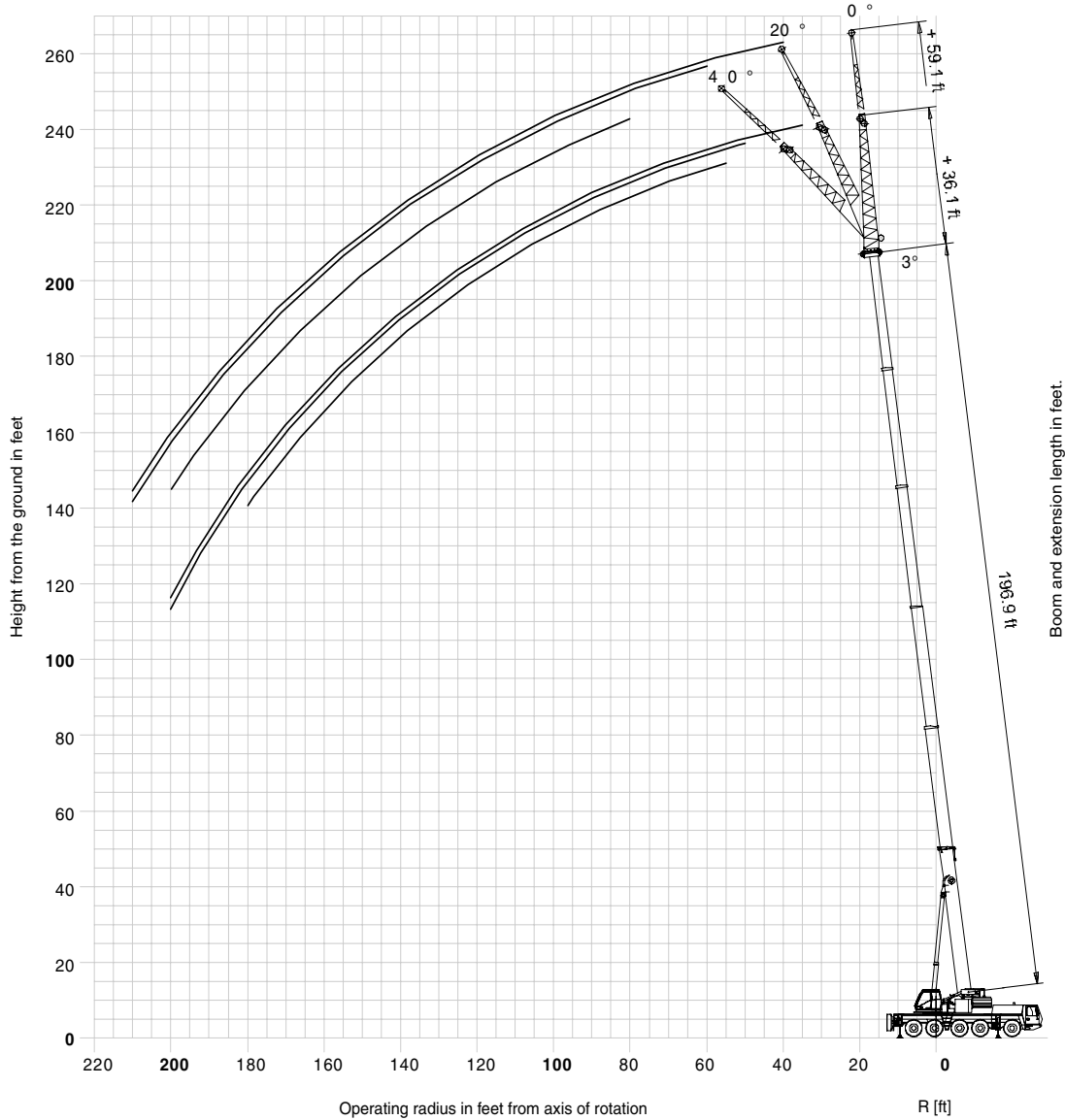

GMK5165

THIS CHART IS ONLY A GUIDE AND SHOULD NOT BE USED TO OPERATE THE CRANE. The individual crane's load chart, operating instructions and other instructional plates must be read and understood prior to operating the crane.

GROVE.



# working range

hydraulic offset swingaway

42'-197' main boom

12

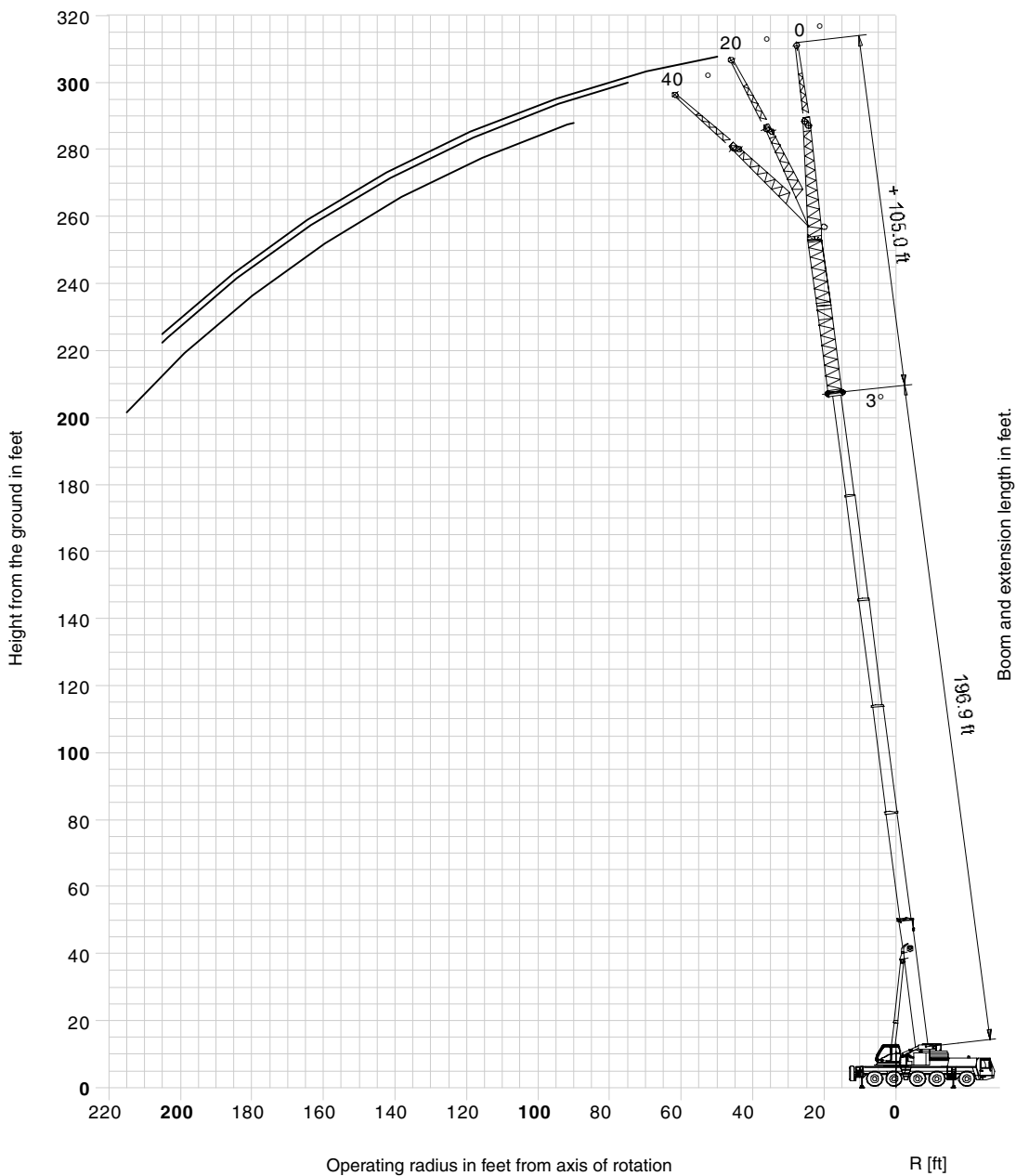

GMK5165

THIS CHART IS ONLY A GUIDE AND SHOULD NOT BE USED TO OPERATE THE CRANE. The individual crane's load chart, operating instructions and other instructional plates must be read and understood prior to operating the crane.

GROVE



# load charts

## hydraulic offsettable swingaway

Feet	36 FT			59 FT			85 FT			105 FT		
	0°	0°-20°	20°-40°	0°	0°-20°	20°-40°	0°	0°-20°	20°-40°	0°	0°-20°	20°-40°
20												
25												
30												
35	11.6											
40	11.6			8.0								
45	11.6			8.0								
50	11.6	11.6		8.0			5.6			4.2		
55	11.6	11.6	11.6	8.0			5.6			4.2		
60	11.6	11.6	11.6	8.0	8.0		5.6			4.2		
65	11.6	11.6	11.6	8.0	8.0		5.6			4.2		
70	11.6	11.6	11.6	8.0	8.0		5.6	5.6		4.2		
75	11.6	11.6	11.6	8.0	8.0		5.6	5.6		4.2	4.2	
80	11.6	11.6	11.6	8.0	8.0	8.0	5.6	5.6		4.2	4.2	
85	11.6	11.6	11.6	8.0	8.0	8.0	5.6	5.6		4.2	4.2	
90	11.6	11.6	11.6	8.0	8.0	8.0	5.6	5.6	5.6	4.2	4.2	4.0
95	11.6	11.6	11.6	8.0	8.0	8.0	5.6	5.6	5.6	4.2	4.2	4.0
100	11.4	11.4	11.4	8.0	8.0	8.0	5.6	5.6	5.6	4.2	4.2	4.0
105	11.0	10.8	11.0	8.0	8.0	8.0	5.6	5.6	5.6	4.2	4.2	4.0
110	10.6	10.4	10.6	8.0	8.0	8.0	5.6	5.6	5.6	4.2	4.2	4.0
115	10.0	10.0	10.0	8.0	8.0	8.0	5.6	5.6	5.6	4.2	4.2	4.0
120	9.6	9.6	9.6	8.0	8.0	8.0	5.6	5.6	5.6	4.2	4.2	4.0
125	9.2	9.2	9.2	8.0	8.0	8.0	5.6	5.6	5.6	4.2	4.2	4.0
130	8.8	8.8	8.8	7.8	7.8	8.0	5.6	5.6	5.6	4.2	4.2	4.0
135	8.4	8.4	8.6	7.4	7.6	7.8	5.6	5.6	5.6	4.2	4.2	4.0
140	8.0	8.0	8.2	7.2	7.2	7.4	5.6	5.6	5.6	4.2	4.2	4.0
145	7.8	7.8	7.8	6.8	7.0	7.2	5.6	5.6	5.6	4.2	4.2	4.0
150	7.4	7.4	7.6	6.6	6.6	6.8	5.4	5.4	5.6	4.2	4.2	4.0
155	6.8	6.8	7.2	6.4	6.4	6.6	5.0	5.2	5.6	4.2	4.2	4.0
160	6.2	6.2	6.6	6.0	6.2	6.4	4.8	5.0	5.2	4.0	4.2	4.0
165	5.4	5.4	6.0	5.8	6.0	6.2	4.6	4.8	5.0	3.8	4.0	4.0
170	5.0	5.0	5.2	5.6	5.6	5.8	4.4	4.6	4.8	3.6	3.8	4.0
175	4.4	4.4	4.8	5.2	5.2	5.6	4.2	4.4	4.6	3.4	3.6	4.0
180	3.8	3.8	4.2	4.6	4.6	5.4	4.0	4.2	4.4	3.2	3.4	3.8
185	3.4	3.4		4.0	4.0	4.8	3.8	4.0	4.2	3.0	3.2	3.6
190	2.8	2.8		3.6	3.6	4.2	3.6	3.6	4.0	3.0	3.2	3.4
195	2.4	2.4		3.2	3.2	3.8	3.2	3.2	3.8	2.8	3.0	3.2
200	2.0	2.0		2.8	2.8	3.2	2.8	2.8	3.4	2.6	2.6	3.0
205				2.4	2.4		2.4	2.4	3.0	2.2	2.2	
210				2.0	2.0		2.0	2.0				2.8
215									2.0			2.4
220												2.0
225												

13

Feet	36 FT			59 FT			85 FT			105 FT		
	0°	0°-20°	20°-40°	0°	0°-20°	20°-40°	0°	0°-20°	20°-40°	0°	0°-20°	20°-40°
20												
25												
30												
35	11.6											
40	11.6			8.0								
45	11.6			8.0								
50	11.6	11.6		8.0			5.6			4.2		
55	11.6	11.6	11.6	8.0			5.6			4.2		
60	11.6	11.6	11.6	8.0	8.0		5.6			4.2		
65	11.6	11.6	11.6	8.0	8.0		5.6			4.2		
70	11.6	11.6	11.6	8.0	8.0		5.6	5.6		4.2		
75	11.6	11.6	11.6	8.0	8.0		5.6	5.6		4.2	4.2	
80	11.6	11.6	11.6	8.0	8.0	8.0	5.6	5.6		4.2	4.2	
85	11.6	11.6	11.6	8.0	8.0	8.0	5.6	5.6		4.2	4.2	
90	11.0	11.0	11.6	8.0	8.0	8.0	5.6	5.6	5.6	4.2	4.2	4.0
95	9.8	9.8	11.0	8.0	8.0	8.0	5.6	5.6	5.6	4.2	4.2	4.0
100	8.8	8.8	9.8	8.0	8.0	8.0	5.6	5.6	5.6	4.2	4.2	4.0
105	7.8	7.8	8.6	8.0	8.0	8.0	5.6	5.6	5.6	4.2	4.2	4.0
110	6.8	6.8	7.6	7.4	7.4	8.0	5.6	5.6	5.6	4.2	4.2	4.0
115	6.0	6.0	6.8	6.6	6.6	8.0	5.6	5.6	5.6	4.2	4.2	4.0
120	5.2	5.2	6.0	5.8	5.8	7.2	5.4	5.4	5.6	4.2	4.2	4.0
125	4.4	4.4	5.2	5.0	5.0	6.4	4.8	4.8	5.6	4.2	4.2	4.0
130	3.8	3.8	4.4	4.4	4.4	5.6	4.2	4.2	5.4	4.0	4.0	4.0
135	3.2	3.2	3.8	3.8	3.8	5.0	3.6	3.6	4.8	3.4	3.4	4.0
140	2.6	2.6	3.2	3.2	3.2	4.4	3.0	3.0	4.2	2.8	2.8	4.0
145	2.0	2.0	2.6	2.6	2.6	3.8	2.4	2.4	3.6	2.2	2.2	3.4
150			2.0	2.2	2.2	3.2	2.0	2.0	3.0			2.8
155						2.6			2.4			2.4
160						2.2			2.0			

**GMK5165**

THIS CHART IS ONLY A GUIDE AND SHOULD NOT BE USED TO OPERATE THE CRANE. The individual crane's load chart, operating instructions and other instructional plates must be read and understood prior to operating the crane.

**GROVE**



# load charts

## manual offsettable swingaway

14

		36 FT			59 FT			85 FT			105 FT	
		0°	20°	40°	0°	20°	40°	0°	20°	40°	0°	40°
20												
25												
30												
35	11.6											
40	11.6				8.0							
45	11.6				8.0							
50	11.6	11.6			8.0			5.6			4.2	
55	11.6	11.6	11.6		8.0			5.6			4.2	
60	11.6	11.6	11.6		8.0	8.0		5.6			4.2	
65	11.6	11.6	11.6		8.0	8.0		5.6			4.2	
70	11.6	11.6	11.6		8.0	8.0		5.6	5.6		4.2	
75	11.6	11.6	11.6		8.0	8.0		5.6	5.6		4.2	4.2
80	11.6	11.6	11.6		8.0	8.0	8.0	5.6	5.6		4.2	4.2
85	11.6	11.6	11.6		8.0	8.0	8.0	5.6	5.6		4.2	4.2
90	11.6	11.6	11.6		8.0	8.0	8.0	5.6	5.6	5.6	4.2	4.2
95	11.6	11.6	11.6		8.0	8.0	8.0	5.6	5.6	5.6	4.2	4.2
100	11.4	11.4	11.4		8.0	8.0	8.0	5.6	5.6	5.6	4.2	4.2
105	11.0	10.8	11.0		8.0	8.0	8.0	5.6	5.6	5.6	4.2	4.2
110	10.6	10.4	10.6		8.0	8.0	8.0	5.6	5.6	5.6	4.2	4.2
115	10.0	10.0	10.0		8.0	8.0	8.0	5.6	5.6	5.6	4.2	4.2
120	9.6	9.6	9.6		8.0	8.0	8.0	5.6	5.6	5.6	4.2	4.2
125	9.2	9.2	9.2		8.0	8.0	8.0	5.6	5.6	5.6	4.2	4.2
130	8.8	8.8	8.8		7.8	7.8	8.0	5.6	5.6	5.6	4.2	4.2
135	8.4	8.4	8.6		7.4	7.6	7.8	5.6	5.6	5.6	4.2	4.2
140	8.0	8.0	8.2		7.2	7.2	7.4	5.6	5.6	5.6	4.2	4.2
145	7.8	7.8	7.8		6.8	7.0	7.2	5.6	5.6	5.6	4.2	4.2
150	7.4	7.4	7.6		6.6	6.6	6.8	5.4	5.4	5.6	4.2	4.2
155	6.8	7.0	7.2		6.4	6.4	6.6	5.0	5.2	5.6	4.2	4.2
160	6.2	6.6	6.8		6.0	6.2	6.4	4.8	5.0	5.2	4.0	4.2
165	5.4	6.0	6.2		5.8	6.0	6.2	4.6	4.8	5.0	3.8	4.0
170	5.0	5.2	5.4		5.6	5.6	5.8	4.4	4.6	4.8	3.6	3.8
175	4.4	4.8	4.8		5.2	5.4	5.6	4.2	4.4	4.6	3.4	3.6
180	3.8	4.2	4.2		4.6	5.2	5.4	4.0	4.2	4.4	3.2	3.4
185	3.4	3.6			4.0	4.8	5.0	3.8	4.0	4.2	3.0	3.2
190	2.8	3.2			3.6	4.2	4.6	3.6	3.8	4.0	3.0	3.2
195	2.4	2.6			3.2	3.8	4.0	3.2	3.6	3.8	2.8	3.0
200	2.0	2.2			2.8	3.2	3.4	2.8	3.4	3.6	2.6	3.0
205					2.4	2.8		2.4	3.0	3.2	2.2	2.8
210					2.0	2.4		2.0	2.4	2.6	2.4	2.6
215						2.0			2.0	2.4		2.4
220											2.0	
225												2.0

		36 FT			59 FT			85 FT			105 FT	
		0°	20°	40°	0°	20°	40°	0°	20°	40°	0°	40°
20												
25												
30												
35	11.6											
40	11.6				8.0							
45	11.6				8.0							
50	11.6	11.6			8.0			5.6			4.2	
55	11.6	11.6	11.6		8.0			5.6			4.2	
60	11.6	11.6	11.6		8.0	8.0		5.6			4.2	
65	11.6	11.6	11.6		8.0	8.0		5.6			4.2	
70	11.6	11.6	11.6		8.0	8.0		5.6	5.6		4.2	
75	11.6	11.6	11.6		8.0	8.0		5.6	5.6		4.2	4.2
80	11.6	11.6	11.6		8.0	8.0	8.0	5.6	5.6		4.2	4.2
85	11.6	11.6	11.6		8.0	8.0	8.0	5.6	5.6		4.2	4.2
90	11.0	11.6	11.6		8.0	8.0	8.0	5.6	5.6	5.6	4.2	4.2
95	9.8	11.0	11.6		8.0	8.0	8.0	5.6	5.6	5.6	4.2	4.2
100	8.8	9.8	10.6		8.0	8.0	8.0	5.6	5.6	5.6	4.2	4.2
105	7.8	8.6	9.4		8.0	8.0	8.0	5.6	5.6	5.6	4.2	4.2
110	6.8	7.6	8.4		7.4	8.0	8.0	5.6	5.6	5.6	4.2	4.2
115	6.0	6.8	7.4		6.6	8.0	8.0	5.6	5.6	5.6	4.2	4.2
120	5.2	6.0	6.4		5.8	7.2	8.0	5.4	5.6	5.6	4.2	4.2
125	4.4	5.2	5.6		5.0	6.4	7.4	4.8	5.6	5.6	4.2	4.2
130	3.8	4.4	4.8		4.4	5.6	6.6	4.2	5.4	5.6	4.0	4.2
135	3.2	3.8	4.2		3.8	5.0	5.8	3.6	4.8	5.6	3.4	4.2
140	2.6	3.2	3.6		3.2	4.4	5.2	3.0	4.2	5.0	2.8	4.0
145	2.0	2.6	3.0		2.6	3.8	4.4	2.4	3.6	4.4	2.2	3.4
150		2.0	2.4		2.2	3.2	3.8	2.0	3.0	3.8	2.6	3.6
155						2.6	3.2		2.4	3.2		3.2
160						2.2	2.8		2.0	2.6		2.6
165							2.2			2.2		2.0
170												
175												
180												
185												

**GMK5165**

THIS CHART IS ONLY A GUIDE AND SHOULD NOT BE USED TO OPERATE THE CRANE. The individual crane's load chart, operating instructions and other instructional plates must be read and understood prior to operating the crane.

**GROVE**

**notes****15****GMK5165****GROVE.**

# GROVE®

**Manitowoc Crane Group - Americas**

Manitowoc, Wisconsin Facility

Tel: [Int + 001] 920 684 6621

Fax: [Int + 001] 920 683 6277

Shady Grove, Pennsylvania Facility

Tel: [Int + 001] 717 597 8121

Fax: [Int + 001] 717 597 4062

**Manitowoc Crane Group - EMEA**

Europe Middle East & Africa

Tel: [Int + 33] (0) 191 565 6281

Fax: [Int + 33] (0) 4 72 18 20 20

**Manitowoc Crane Group - UK**

Europe Middle East & Africa

Tel: [Int + 44] (0) 191 565 6281

Fax: [Int + 44] (0) 191 564 0442

**Manitowoc Crane Group - Germany**

(Sales, Parts & Service)

Tel: [Int + 49](0) 2173 8909 0

Fax: [Int + 49] (0) 2173 8909-30

**Manitowoc Crane Group - France**

France & Africa (Sales, Parts & Service)

Tel: [Int + 33] (0) 1 303 13150

Fax: [Int + 33] (0) 1 303 86085

**Manitowoc Crane Group - Netherlands**

(Sales, Parts & Service)

Tel: [Int + 31] (0) 76 578 39 99

Fax: [Int + 31] (0) 76 578 39 78

**Manitowoc Crane Group - Italy**

Italy & Southern Europe (Sales, Parts & Service)

Tel: [Int + 39] (0) 331 49 33 11

Fax: [Int + 39] (0) 331 49 33 30

**Manitowoc Crane Group - Portugal**

Portugal & Spain (Sales, Parts & Service)

Tel: [Int + 351] (0) 22 968 08 89

Fax: [Int + 351] (0) 22 968 08 97

**Manitowoc Crane Group - Singapore**

Asia/Pacific excl China (Sales, Parts & Service)

Tel: [Int + 65] 6861 1733

Fax: [Int + 65] 6862 4040 / 4142

**Manitowoc Crane Group - Shanghai**

China (Sales, Parts & Service)

Tel: [Int + 86] (0) 21 64955555

Fax: [Int + 86] (0) 2164852038

**Manitowoc Crane Group - Beijing**

China (Sales, Parts & Service)

Tel: [Int + 86] (0) 10 646 71690

Fax: [Int + 86] (0) 10 646 71691

**Manitowoc Crane Group - Middle East**

(Sales)

Tel: [Int + 971] (0) 4 348 4478

Fax: [Int + 971] (0) 4 348 4478

(Parts & Service)

Tel: [Int + 973] (0) 9 660 899

Fax: [Int + 973] (0) 2 707 740

**Distributed By:**

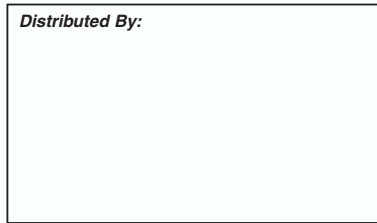

www.manitowoccrane.com



Constant improvement and engineering progress make it necessary that we reserve the right to make specification, equipment, and price changes without notice. Illustrations shown may include optional equipment and accessories, and may not include all standard equipment.

