

Grove Maniowoc National Crane Potain



Grove GMK5170

Product Guide



170 t



64 m



11 - 34 m



101 m

All-Terrain Crane • AT-Kran
Grue Automotrice Routière
Grúa Todo Terreno Rapida • Gru Fuoristrada Veloci
Вездеходный подъемный кран



Contents • Inhalt • Contenu • Contenido Contenuto • Содержание

Specification	3
Technische Daten	4
Caractéristiques techniques	5
Características	6
Caratteristiche	7
Технические характеристики	8
Data • Daten • Caractéristiques • Datos • Dati • Данные	9
Dimensions • Abmessungen • Encombrement • Dimensiones • Dimensioni • Размеры	10
Counterweight • Gegengewicht • Contrepoids • Contrapesos • Contrappesi • Противовес	11
Load charts • Traglasten • Capacités de levage • Capacidades • Capacità • Таблицы грузоподъемности	
Notes • Hinweise • Notes • Notas • Note • Примечания	13
Overview • Übersicht • Tableau synoptique • Resumen de las tablas • Tabella riassuntiva • Общие сведения	14
Working Range • Arbeitsbereiche • Diagramme de levage • Gama de trabajo	
Area di lavoro • Грузовысотные характеристики	15
Telescopic Boom • Teleskopausleger • Flèche principale • Pluma telescópica	
Braccio telescopico • Телескопическая стрела	16
Jib configurations • Kombination der Auslegerverlängerung • Combinaisons de l'extension treillis	
Configuración con extensiones de pluma • Combinazioni delle prolunghe del falcone • Конфигурация стрелы	21
Swingaway (hydraulic luffing) • Klappspitze (hydraulisch wippbar) • Extension treillis (déport hydraulique)	
Plumín (angulable hidráulicamente) • Falcone (brandeggio idraulico) • Удлинитель стрелы с гидравлическим изменением вылета.	23
Integrated heavy duty jib • Integrierte Schwerlastspitze • Flèche intégrée haute résistance	
Pluma integrada de alta resistencia • Braccio integrato ad alta resistenza	
Интегрированная стрела для тяжелых условий эксплуатации	31
Symbols • Symbolerklärung • Glossaire des symboles • Glosario de simbolos • Glossario dei simboli • Символы	35



Manitowoc Crane Care is the Manitowoc's unparalleled product support organisation. Manitowoc Crane Care combines all aspects of parts, service, technical documentation, technical support and training into one organisation. The program includes all of the Manitowoc's brands, which include, Potain, Grove, Manitowoc and National Crane.

For the care of your crane and the prosperity of your business, Manitowoc Crane Care is your single source for customer support. Wherever, whenever, whatever – we're there.

Manitowoc Crane Care vereint alle Serviceleistungen von Manitowoc im Produktsupport vor und nach dem Verkauf: Ersatzteile, Service, technische Dokumentation, technischer Support und Schulung, alles unter einem Dach. Dieser Service erstreckt sich auf alle Marken von Manitowoc: Potain, Grove, Manitowoc und National Crane.

Support und Schulung, alles unter einem Dach. Dieser Service erstreckt sich auf alle Marken von Manitowoc: Potain, Grove, Manitowoc und National Crane.

Damit Ihr Kran leistungsfähig bleibt und Ihr Erfolg gesichert ist, bietet Ihnen Manitowoc Crane Care einen umfassenden Support aus einer Hand. Zu jeder Zeit, an jedem Ort, für jeden Fall – wir sind für Sie da.

Organisation hors pair dédiée au support technique des produits de Manitowoc, Manitowoc Crane Care réunit au sein d'une même entité tous les aspects du service : pièces de rechange, service après-vente, publication technique, assistance technique et formation. Ce programme s'adresse à toutes les marques de Manitowoc : Potain, Grove, Manitowoc et National Crane.

Pour assurer l'entretien de vos grues et la prospérité de votre entreprise, Manitowoc Crane Care constitue votre unique interlocuteur du service à la clientèle. Où que vous soyez, quel que soit votre besoin, vous pouvez toujours compter sur nous !

Manitowoc Crane Care, es la organización post-venta y soporte técnico de Manitowoc. Manitowoc Crane Care combina todos los aspectos de piezas de repuesto, servicio, documentación técnica, apoyo técnico y formación en un único lugar. El programa también incluye todas las ramas Manitowoc que engloba Potain, Grove, Manitowoc y National Crane.

Para el cuidado de su grúa y la prosperidad de su negocio, Manitowoc Crane Care, es la forma más sencilla de ayudarle. Donde sea y cuando sea, nosotros estamos allí.

Manitowoc Crane Care è l'ineguagliabile organizzazione di supporto di Manitowoc. Manitowoc Crane Care gestisce tutte le attività legate a pezzi di ricambio, documentazione tecnica, assistenza tecnica e formazione riunite in un unico punto di riferimento. Questo servizio è attivo per tutti i marchi di Manitowoc e precisamente Potain, Grove, Manitowoc e National Crane.

Per l'assistenza delle Vostre gru e per la redditività dei Vostri investimenti, Manitowoc Crane Care è l'insostituibile Vostra risorsa. In ogni posto, tutte le volte, per qualsiasi necessità – noi ci siamo

Manitowoc Crane Care - это не имеющая аналогов организация, входящая в Manitowoc и осуществляющая техническую поддержку продукции. Manitowoc Crane Care занимается всеми аспектами, связанными с запасными частями, услугами, технической документацией, технической поддержкой и обучением. Программа включает все торговые марки Manitowoc, в том числе, Potain, Grove, Manitowoc и National Crane.

Manitowoc Crane Care является единой точкой контактов для всех клиентов компании, где они могут получить полное обслуживание для используемых ими кранов, что, в свою очередь, обеспечит процветание их бизнеса. Мы всегда там и в тот момент, где и когда мы необходимы.



Specifications

Superstructure



Boom

13,7 m to 64,0 m six section TWIN-LOCK™ boom.
Maximum tip height 67,0 m.



Boom elevation

1 cylinder with safety valve, boom angle from -1,5° to +83°.



Load moment and independent anti-two block system

Load moment and independent anti-two block system with audio visual warning and control lever lock-out. These systems provide graphic display of boom angle, length, radius, tip height, relative load moment, maximum permissible load, load indication and warning of impending two-block condition with lock-out hoist function.



Cab

Aluminium, full vision, tiltable (approx. 20°), safety glass, adjustable operator's seat with suspension, engine-dependent hot water heater. Armrest-integrated crane controls. Ergonomically arranged instrumentation and crane operating controls.



Slewing

3 slewing gears with axial piston motors, planetary gear, automatic brake with foot operated release switch for free slew.



Counterweight

Fixed 2 tonnes. Hydraulic removal system.



Engine

Mercedes-Benz OM906LA, diesel, 6 cylinders, water cooled, turbocharged, 170kW (231 HP) at 2200 rpm. (80/1269 EWG - fan rigid). Max. torque: 810 Nm at 1200 rpm. Fuel tank capacity: 240 l.

Engine emission: EUROMOT 3 / EPA / CARB (non road).



Hydraulic system

2 separate circuits, 1 axial piston variable displacement pump (load sensing), with electronic power limiting control and 1 double gear pump for slewing. Thermostatically controlled oil cooler. Tank capacity: 915 l.



Control system

Full electronic control of all crane movements using electrical control levers with automatic reset to zero. Integrated with the LMI and engine management system by CAN-BUS. ECOS system with graphic display.



Hoist

Axial piston motor with planetary gear and brake. Drum rotation indicator.



Electrical system

Three-phase alternator 28 V/80 A, 2 batteries 12 V/170 Ah.

* Optional equipment

- Bi-fold swingaway, 11/18 m - with hydraulic offset and luffing under load (0° - 40°), controlled from the crane cab.
- Lattice extension, 26/34 m - includes 2 x 8 m fixed, non-offsettable sections plus 11/18 m swingaway (see above).
- 3,6 m integrated 3 sheave heavy duty jib (max. 38 t).
- Additional 51 tonnes counterweight (total counterweight 53 tonnes).
- Auxiliary hoist.
- Engine-independent hot water heater, with engine pre-heater.

Carrier



Chassis

Special 5-axle chassis, all-welded torsion-resistant box type construction in high strength steel.



Outriggers

4 double hydraulically telescoping beams with vertical cylinders and outrigger pads. Independent horizontal and vertical movement control on each side of the carrier and from the operators cab. Electronic level indicator with automatic levelling system. Working light for each outrigger beam.



Engine

Mercedes-Benz OM502LA, diesel, 8 cylinders, water cooled, turbocharged, 420 kW (571 HP) at 1800 rpm (80/1269 EWG - fan loose). Max. torque: 2700 Nm at 1300 rpm. Fuel tank capacity: 360 l.

Engine emission: EUROMOT / EPA / CARB (non road).



Transmission

Allison automatic HD 4000 SP, 6 forward and 1 reverse speed. Transverse differential locks. Two speed transfer case with inter-axle differential lock.



Drive/Steer

10 x 6 x 10.



Axle lines

5 axle lines. 3, 4 and 5 are driven steering axle lines, the 1st and 2nd are steering axle lines.



Suspension

MEGATRAK®. All wheels with independent hydropneumatic suspension and hydraulic lockout. Longitudinal and transverse level control with automatic on-highway levelling system. Range +160 mm/-120 mm.



Tyres

10 tyres, 14.00 R25 (385/95 R25).



Steering

Dual circuit, hydraulic power assisted steering with emergency steering pump. Axle lines 1, 2, 3 and 5 steer on highway (steer by wire). Separate electronic hydraulic (steer by wire) steering of the 4th, and 5th axle line for all wheel steering and crabbing.



Brakes

Service brake: pneumatic dual circuit, acting on all wheels, air dryer. Permanent brake: exhaust brake and constant throttle brake.

Parking brake: pneumatically operated spring-loaded brake acting on axle lines 2, 3, 4 and 5.



Cab

Aluminium, 2-man-design, safety glass, driver seat with pneumatic suspension, engine-dependent hot water heater. Complete instrumentation and driving controls.



Electrical system

Three-phase alternator 28 V/100A, 2 batteries 12 V/170 Ah. Lighting system and signals 24 V.

* Optional equipment

- 10 x 8 x 10.
- Transmission intergrated hydraulic retarder.
- 10 tyres, 16.00 R25 (445/95 R25).
- 10 tyres, 20.5 R25 (525/80 R25). (Vehicle width 3,11 m).
- Folding bunk bed in carrier cab.
- Engine-independent hot water heater, with engine pre-heater.
- Reversing camera system.

*Further optional equipment upon request.

Technische Daten

Kranoberwagen



Teleskopausleger

Von 13,7 m bis 64,0 m ausfahrbarer, sechsteiliger TWIN-LOCK™ Ausleger. Maximale Rollenhöhe 67,0 m.



Wippwerk

1 Zylinder mit Sicherheits-Rückschlagventil. Auslegerverstellwinkel -1,5° bis +83°.



Elektronischer Lastmomentbegrenzer und unabhängiges Hubendschalter System

Elektronischer Lastmomentbegrenzer mit hör- und sichtbarer Vorwarnung sowie automatischer Abschaltung, grafische Anzeige für tatsächliche und zulässige Belastung, Ausladung und diverse Zustände. Unabhängiges Hubendschalter System mit Abschaltfunktion.



Krankkabine

Vollsicht-Aluminium-Kabine, ca. 20° kippbar, Sicherheitsglas, verstellbarer Fahrersitz mit Dämpfung. In Armlehnen integrierte Kransteuereinrichtung. Ergonomisch angeordnete Steuer- und Kontrolleinrichtungen. Motorabhängige Warmwasserheizung.



Drehwerk

3 Drehwerke mit Axialkolbenmotoren, Planetengetriebe, automatische Bremse, Freischaltung über Fußtaster.



Gegengewicht

2 t. Hydraulisches Rüstsystem.



Motor

Mercedes-Benz OM906LA, 6 Zylinder Diesel, wassergekühlt mit Abgasturbolader, 170 kW (231 PS) bei 2200 min⁻¹ (80/1269/EWG Ventilator starr), max. Drehmoment 810 Nm bei 1200 min⁻¹. Kraftstoffbehälter: 240 l. Motoremission: EUROMOT 3 / EPA / CARB (non road).



Hydrauliksystem

2 separate Kreisläufe, 1 Axialkolben-Verstellpumpe (load sensing) mit elektronischer Grenzlastregelung und 2 Zahnradpumpen für das Drehwerk. Thermostatisch gesteuerter Ölkühler. Tankvolumen: 915 l Hydrauliköl.



Steuerung

Voll elektronische Steuerung aller Bewegungen mit elektrischen Kreuzsteuerhebeln mit automatischer Nullstellung, verbunden mit der LMB und dem Motormanagement System über einen CAN-BUS. ECOS System mit grafischer Anzeige.



Hubwerk

Axialkolbenmotor mit Planetengetriebe und Bremse. Hubwerksdrehmelder.



Elektrische Anlage

Drehstromlichtmaschine 28 V/80 A, 2 Batterien 12 V/170 Ah.

* Zusatzausrüstung

- Doppelklappspitze 11/18 m Anlenkung 0°- 40°. Aus der Krankkabine hydraulisch einstellbar und unter Teillast wippbar.
- Auslegerverlängerung, Gitterkonstruktion 26/34 m, bestehend aus Doppelklappspitze (siehe oben) und 1 bzw. 2 Verlängerungsstücke zu je 2 x 8 m.
- 3,6 m integrierte Schwerlastspitze (3 rollig, max. 38 t).
- Zusatzgegengewicht 51 t (Gesamtgegengewicht 53 t).
- Hilfshubwerk.
- Motorunabhängige Warmwasser-Standheizung mit Motorvorwärmung.

Kranunterwagen



Rahmen

5-Achs-Spezialfahrzeug, geschweißte, torsionssteife Kastenkonstruktion aus hochfestem Feinkornstahl.



Abstützung

4 hydraulisch doppelt teleskopierbare Schiebeträger mit Abstützzyllindern und Abstützplatten, beidseitig vom Unterwagen und aus der Krankkabine einzeln horizontal und vertikal steuerbar. Elektronische Niveauanzeige mit automatischer Nivellierung. Arbeitsscheinwerfer montiert am Abstützträger.



Motor

Mercedes-Benz OM502LA, 8 Zylinder Diesel, wassergekühlt mit Abgasturbolader, 420 kW (571 PS) bei 1800 min⁻¹ (80/1269/EWG Ventilator lose), max. Drehmoment 2700 Nm bei 1300 min⁻¹. Kraftstoffbehälter: 360 l. Motoremission: EUROMOT / EPA / CARB (non road).



Getriebe

Allison Getriebeautomat HD 4000 SP, 6 Gänge vorwärts und 1 rückwärts. Querdifferentialsperren. Verteilergetriebe 2 stufig mit Längsdifferentialsperre.



Antrieb/Lenkung

10 x 6 x 10.



Achslinien

5 Achslinien, Achslinie 3, 4 und 5 gelenkt und angetrieben. Achslinie 1 und 2 gelenkt.



Federung

MEGATRAK®. Alle Räder in Einzelradaufhängung, hydropneumatische Federung und hydraulische Blockierung. Neigungsverstellung in alle Richtungen und automatische Straßenfahrtniveaueinstellung. Federweg +160mm/-120mm.



Bereifung

10 Reifen, Größe 14.00 R25 (385/95 R 25).



Lenkung

Zweikreis-Hydraulenklung mit Notlenkpumpe. Während der Straßenfahrt werden die 1., 2., 3. und 5. Achse (steer by wire) gelenkt. Separate elektronisch-hydraulische Lenkung der 4. und 5. Achslinie für Allradlenkung und Krabbengang.



Bremsen

Betriebsbremse: pneumatische Zweikreisbremse, auf alle Räder wirkend, Lufttrockner. Dauerbremse: Motorklappenbremse mit Konstantdrossel. Feststellbremse: Druckluftbetätigte Federspeicherbremse auf 2., 3., 4. und 5. Achslinie wirkend.



Fahrerhaus

Aluminium, 2-Mann-Fahrerhaus, Sicherheitsglas, luftgedämpfter Fahrersitz, motorabhängige Warmwasserheizung. Kontroll- und Bedienungseinrichtung für Fahrbetrieb.



Elektrische Anlage

Drehstromlichtmaschine 28 V/100 A, 2 Batterien 12 V/170 Ah, Beleuchtung und Signaleinrichtung 24 V.

* Zusatzausrüstung

- 10 x 8 x 10.
- Getriebeintegrierter hydraulischer Retarder.
- 10 Reifen, Größe 16.00 R25 (445/95 R 25).
- 10 Reifen, Größe 20.5 R25 (525/80 R 25). (Fahrzeugbreite 3,11 m).
- Klappliege im Fahrerhaus
- Motorunabhängige Warmwasser-Standheizung mit Motorvorwärmung.
- Rückfahrkamera-system.

*Weitere Zusatzausrüstungen auf Anfrage.



Caractéristiques techniques

Superstructure



Flèche

Flèche six éléments de 13,7 m à 64,0 m, à télescopage TWIN-LOCK™.
Hauteur maximum de tête de flèche 67,0 m.



Relevage

1 vérin avec clapet anti-retour, angle de relevage de - 1,5° à +83°.



Contrôleur d'état de charge et dispositif de fin de course haute crochet indépendant

Equipements électroniques de contrôle de charge et de fin de course haute crochet indépendants avec dispositifs de signalisation sonore et visuelle et de coupure des mouvements. Affichage graphique d'angle et de longueur de flèche, de portée, de hauteur de tête de flèche, de moment relatif, de charge maximum autorisée, d'état de charge et d'approche de fin de course haute crochet avec coupure du mouvement de montée de treuil.



Cabine

Cabine **Aluminium**, inclinable (angle d'inclinaison environ 20°), largement vitrée, avec vitrage de sécurité, hydraulique suspendu et chauffage à eau chaude alimenté par le moteur. Disposition ergonomique des commandes de grue intégrées dans les accoudoirs et de l'instrumentation.



Orientation

Dispositif d'orientation triple avec moteurs hydrauliques à pistons axiaux, frein à serrage automatique et commande d'orientation libre au pied.



Contrepoids

Contrepoids fixe de 2 tonnes. Système de dépose hydraulique.



Moteur

Moteur Diesel Mercedes-Benz OM906LA, 6 cylindres suralimenté, refroidi par eau et développant 170 kW (231 CV) à 2200 min⁻¹. (80/1269 EWG - ventilateur en prise directe). Couple maxi 810 Nm à 1200 min⁻¹. Capacité du réservoir : 240 l. Conformité aux normes de pollution EUROMOT 3 / EPA / CARB (tout terrain).



Système hydraulique

2 circuits indépendants, 1 pompe à pistons axiaux avec système (load sense) de contrôle de charge et 1 pompe double à engrenages pour l'orientation. Refroidisseur d'huile à commande thermostatique. Capacité du réservoir : 915 l.



Commande

Commandes de grue électroniques par manipulateurs électriques avec retour au neutre automatique. Ces commandes sont reliées au contrôleur d'état de charge et au dispositif de gestion du moteur thermique par système CAN-BUS. Système ECOS avec affichage graphique.



Treuil de levage

Treuil avec tambour rainuré, réducteur à planétaires, frein multidisque, moteur à pistons axiaux et indicateur de rotation.



Installation électrique

Alternateur triphasé 28 V/80 A et 2 batteries 12 V/170 Ah.

* Equipements optionnels

- Extension treillis à repliage latéral double de 11/18 m - avec déport hydraulique et inclinaison sous charge (0°- 40°), commandés depuis la cabine.
- Extension treillis de 26/34 m constituée d'extensions treillis double de 11/18 m plus éléments intermédiaires de 2 x 8 m.
- Extension treillis intégrée de 3,6 m, 3 réas, pour levages lourds (max. 38 t).
- Contrepoids supplémentaire de 51 t (Contrepoids total 53 t).
- Treuil auxiliaire.
- Chauffage auxiliaire à eau chaude indépendant avec dispositif de préchauffage moteur.

Porteur



Châssis

Porteur spécial, « 5 lignes d'essieux », mécanosoudé, type caisson, en acier à haute limite élastique.



Calage

4 poutres à télescopage hydraulique, avec vérins et patins d'appui. Commande indépendante des mouvements verticaux et horizontaux sur les deux côtés du porteur et depuis la cabine de l'opérateur. Indicateur de mise à niveau électronique avec système de mise à niveau automatique. Projecteur de travail sur les bras de télescopage.



Moteur

Moteur Diesel Mercedes-Benz OM502LA, 8 cylindres suralimenté, refroidi par eau et développant 420 kW (571 CV) à 1800 min⁻¹ (80/1269 EWG - ventilateur débrayable). Couple maxi 2700 Nm à 1300 min⁻¹. Capacité du réservoir : env. 360 l. Conformité aux normes de pollution EUROMOT / EPA / CARB (tout terrain).



Boîte de vitesses

Boîte de vitesses automatique Allison HD 4000 SP. 6 rapports de marche avant et 1 rapport de marche arrière. Différentiel inter-roues. Boîte de transfert avec verrouillage longitudinal du différentiel.



Direction/Transmission

10 x 6 x 10.



Lignes d'essieux

5 lignes d'essieux. Lignes d'essieux 3, 4, et 5 directrices et motrices, lignes d'essieux 1 et 2 directrices.



Suspension

Suspension hydropneumatique à roues indépendantes MEGATRAK® et dispositif de verrouillage. Commandes de mise à niveau longitudinal et transversal. Dispositif de mise à niveau automatique en position route. Débattement: +160 mm/-120 mm.



Pneumatiques

10 pneumatiques 14.00 R25 (385/95 R25).



Direction

Direction assistée à double circuit et pompe de secours. Lignes d'essieu 1, 2, 3 et 5 directionnelles sur route (direction par câble). Direction hydraulique et électronique indépendante (direction par câble) direction indépendante pour les lignes d'essieux 4 et 5 pour réduction du diamètre de braquage et déplacement latéral (marche en crabe).



Freins

Frein de service pneumatique à double circuit agissant sur toutes les roues. Dessiccateur. Ralentisseur par clapet sur échappement et décalage de la distribution. Frein de stationnement à ressorts commandé pneumatiquement agissant sur les lignes d'essieux 2, 3, 4 et 5.



Cabine

Cabine bi-place en **aluminium** avec vitrage de sécurité, suspension pneumatique suspendu, chauffage à eau chaude alimenté par le moteur et instrumentation complète pour le contrôle et la conduite de la machine.



Installation électrique

Alternateur triphasé 28 V/100 A et 2 batteries 12 V/170 Ah, équipement d'éclairage et de signalisation routière : 24 V.

* Equipements optionnels

- Configuration 10 x 8 x10
- Ralentisseur hydraulique intégré au système de transmission.
- 10 pneumatiques 16.00 R25 (445/95 R25).
- 10 pneumatiques 20.5 R25 (525/80 R25). (Largeur du véhicule 3,11 m).
- Banquette repliable dans la cabine porteur.
- Chauffage auxiliaire à eau chaude indépendant avec dispositif de préchauffage moteur.
- Caméra de recul.

* Autres équipements optionnels sur demande.

Características

Superestructura



Pluma

De 13,7 m a 64,0 m seis tramos de telescopaje TWIN-LOCK™. Altura máxima en punta 67,0 m.



Elevación de pluma

Un cilindro con válvula de seguridad. Angulo de pluma desde -1,5° hasta +83°.



Sistema Indicador del Momento de Carga y de Final de Carrera del Gancho

Sistema Indicador del Momento de Carga y de Final de Carrera del Gancho, con alarma audio-visual y bloqueo automático de las palancas. Este sistema incluye pantalla gráfica con indicación de ángulo de pluma, longitud, radio, altura de cabeza de pluma, momento de carga relativo, carga máxima permisible, carga real y alarma de fin de carrera del gancho con bloqueo del movimiento de elevación.



Cabina

De **Aluminio** basculable (aprox. 20°), amplia visibilidad, cristales de seguridad, asiento del operador ajustable y con hidráulica suspensión. Calefacción dependiente del motor por agua caliente. Controles de la grúa integrados en el apoya-brazos. Controles de operación de la grúa e instrumentación ergonómicamente situados.



Giro

Tres reductores de giro con motores de pistón axial, engranaje planetario, freno automático con interruptor de desconexión accionado por pedal para giro libre.



Contrapeso

Fijo de 2 Tm. Sistema hidráulico para desmontaje.



Motor

Diesel Mercedes Benz OM906LA, 6 cilindros, refrigerado por agua, turbo-alimentado, 170 Kw (231 PS) a 2200 r.p.m. (80/1269 EWG - ventilador fijo). Par máximo: 810 Nm a 1200 r.p.m. Capacidad del depósito de combustible: 240 l. Emisión de gases: Según normas EUROMOT 3 / EPA / CARB (fuera de carretera).



Sistema hidráulico

2 circuitos separados, 1 bomba variable de desplazamiento con pistones axiales (con sensor de carga), con control electrónico de limitación de potencia y 1 bomba de doble marcha para la rotación. Refrigerador del aceite controlado por termostato. Capacidad del depósito: 915 l.



Sistema de control

Control completamente electrónico de todos los movimientos de la grúa, usando palancas de control eléctrico con retorno automático a cero. Integrado con el Limitador de Cargas y el sistema de control del motor por un equipo "CAN-BUS". Sistema ECOS con indicador gráfico.



Cabrestante

Motor de pistón axial con engranaje planetario y freno. Indicador de rotación del tambor.



Sistema eléctrico

Trifásico con alternador 28V/80A, dos baterías de 12v/170 Ah.

* Equipos opcionales

- Plumín articulado en 2 secciones, 11/18 m - con angulación fija y variable, con carga (0° - 40°) de accionamiento hidráulico.
- Extensión de pluma, de celosía, de 26/34 m incluyendo el plumín de 11/18 m (el de arriba) más extensiones de 2 x 8m.
- Plumín integrado de 3,6 m con 3 poleas para cargas pesadas (máx. 38 t).
- Contrapeso adicional de 51 Tm. (Contrapeso total 53 Tm.)
- Cabrestante Auxiliar.
- Calefacción independiente del motor por agua caliente, con precalentamiento del motor.

Chasis



Bastidor

Chasis especial de cinco ejes de construcción soldada tipo cajón, resistente a la torsión, en acero de alta resistencia.



Estabilizadores

Cuatro vigas telescópicas hidráulicas con cilindros verticales y placas de apoyo. Controles independientes para los movimientos horizontales y verticales, con controles en ambos lados del chasis y desde la cabina del operador. Indicador de nivel electrónico con sistema de nivelación automática. Luz de trabajo en cada estabilizador.



Motor

Diesel Mercedes Benz OM502LA, 8 cilindros, refrigerado por agua y turbo-alimentado, 420 Kw (571 PS) a 1800 r.p.m. (80/1269 EWG - ventilador desconectado), par máximo: 2700 Nm, a 1300 r.p.m. Capacidad del Depósito de Combustible: 360 litros. Emisión de gases: Según normas EUROMOT / EPA / CARB (fuera de carretera).



Transmisión

ALLISON automática HD 4000 SP, 6 velocidades adelante y 1 atrás. Candado de diferencial. Caja de transferencia con 2 velocidad y bloqueo diferencial entre ejes.



Tracción/Dirección

10 x 6 x 10.



Ejes

5 ejes en línea. Ejes 3, 4 y 5 motrices y directrices. Ejes 1 y 2 directrices.



Suspensión

MEGATRAK®. Todas las ruedas con suspensión hidroneumática independiente y bloqueo hidráulico. Control de nivel longitudinal y transversal con sistema de nivelación automática en carretera. Desplazamiento +160 mm / -120 mm.



Neumáticos

10 neumáticos, 14.00 R25 (385/95 R25).



Dirección

Dirección servo-asistida con doble circuito con bomba de dirección de emergencia. Los ejes 1, 2, 3 y 5 son directrices para circular por carretera (dirección por cable). Dirección separada hidráulica electrónica separada (dirección por cable) de los ejes 4° y 5° para la dirección en todas las ruedas y conducción tipo cangrejo.



Frenos

Frenos de servicio: Neumático con doble circuito, actuando sobre todas las ruedas, secador de aire. Freno continuo: Freno sobre el escape, con estrangulamiento continuo. Freno de Aparcamiento: Operado neumáticamente y aplicado por muelle sobre los ejes 2°, 3°, 4° y 5°.



Cabina

De **Aluminio**, para dos personas, cristales de seguridad, asientos del conductor y pasajero con neumática suspensión, calefacción por agua caliente del motor. Controles e instrumentación para conducción del vehículo.



Sistema eléctrico

Trifásico, alternador de 28 V/100A, 2 baterías 12 V/170 Ah. Sistema de alumbrado y señalización a 24 V.

* Equipos opcionales

- 10 x 8 x 10.
- Retardador hidráulico integrado en la transmisión.
- 10 neumáticos 16.00 R25 (445/95 R25).
- 10 neumáticos 20.5 R25 (525/80 R25). (Anchura del vehículo: 3,10 m).
- Litera plegable en la cabina del chasis.
- Calefacción independiente del motor por agua caliente, con precalentamiento del motor.
- Sistema de cámara invertida.

* Sigüientes equipos bajo demanda.



Caratteristiche

Torretta



Braccio

Da 13,7 a 64,0 metri; sei sette con sfilamento TWIN-LOCK™. Massima altezza in punta 67,0 metri.



Sollevamento Braccio

Un cilindro con valvola di sicurezza, angolo del braccio da -1,5° a +83°.



Limitatore di carico e blocco dei movimenti

Limitatore di carico e finecorsa con allarme visivo e sonoro e blocco delle leve di comando. Questo sistema è provvisto di grafico display elettronico riportante l'angolo e la lunghezza del braccio, il raggio di lavoro, l'altezza di lavoro, il momento, il carico massimo ammissibile e il carico sollevato. Allarme per prevenire il fine corsa con blocco delle funzioni dell'argano.



Cabina

Costruita in **alluminio** con grande visibilità, ribaltabile (circa 20°), cristalli di sicurezza, sedile dell'operatore con ammortizzatore e riscaldamento (dipendente dal motore). Comandi gru integrati nel bracciolo. Strumentazione e comandi disposti in maniera ergonomica.



Rotazione

Ottenuta con riduttore a planetario, freno automatico, pedale azionabile come controllo rotazione.



Contrappeso

Da 2 ton, fisso. Sistema di rimozione idraulico.



Motore

Mercedes Benz OM906LA, diesel 6 cilindri, raffreddato ad acqua, sovralimentato, potenza di 170 kW (231 HP) a 2200 giri (80/1269 EWG ventola rigida). Coppia massima 810 Nm a 1200 giri.

Capacità del serbatoio: 240 litri. Emissione gassose allo scarico nei limiti: EUROMOT 3 / EPA / CARB (motori non stradali).



Impianto idraulico

2 circuiti indipendenti, 1 pompa a portata variabile a pistone assiale (load sensing), con controllo limitatore della potenza elettronico e 1 pompa a ingranaggi doppia per la rotazione. Refrigeratore dell'olio a controllo termostatico. Capacità serbatoio: 915 l.



Comandi

Controllo completamente elettronico di tutti i movimenti della gru con leve di comando a controllo elettrico con azzeramento automatico. Integrato con il sistema LMI (Limitatore di carico) e con il sistema CAN-BUS di controllo del motore. Sistema ECOS con display grafico.



Argano

Motore a portata variabile con riduttore planetario e freno. Indicatore della rotazione dell'argano.



Impianto elettrico

Alternatore trifase 28V/80 A, due batterie 12V 170Ah.

* Accessori opzionali

- Prolunga tralicciata pieghevole 11/18 metri, con sistema di posizionamento idraulico e angolazione sotto carico (0°- 40°), controllata dalla cabina gru.
- Prolunga tralicciata 26/34 metri inclusi 2 x 8 metri fissi non angolabili, più prolunga tralicciata 11/18 metri (vedi sopra).
- Jib da prefabbricati da 3,6 m con 3 carucole (portata massima 38 t).
- Contrappeso aggiuntivo di 51 tonnellate (contrappeso totale 53 tonnellate).
- Argano ausiliario.
- Riscaldamento autonomo con preriscaldatore motore.

Carro



Telaio

Telaio speciale 5 assi, completamente saldato, in acciaio sciolato ad alta resistenza, resistente alla torsione.



Stabilizzatori

4 travi orizzontali telescopiche con cilindri verticali e piatti stabilizzatori. Controllo dei movimenti verticale ed orizzontale indipendente su ogni lato del carro e dalla cabina dell'operatore. Indicatore elettronico del livello con sistema di livellamento automatico. Luci di lavoro posizionate sopra gli stabilizzatori.



Motore

Mercedes Benz OM502LA diesel 8 cilindri raffreddato ad acqua, sovralimentato, potenza di 420 kW (571 HP) a 1800 giri (80/1269 EWG fan loose). Coppia massima 2700 Nm a 1300 giri. Capacità del serbatoio 360 litri. Emissione gassosa allo scarico nei limiti: EUROMOT / EPA / CARB (motori non stradali).



Cambio

Cambio automatico Allison HD 4000 SP, 6 marce avanti più 1 retromarcia. Bloccaggio differenziale trasversale. Riduttore ripartitore a 2 velocità.



Trazione/Sterzo

10 x 6 x 10.



Assali

5 assi: terzo, quarto e quinto sterzanti e traenti, primo e secondo solo sterzanti.



Sospensioni

MEGATRAK®. Tutte le ruote sono montate su sospensioni idropneumatiche indipendenti con bloccaggio idraulico. Controllo del livellamento longitudinale e trasversale con livellamento automatico per la circolazione stradale. Corsa +160mm/-120mm.



Pneumatici

10 pneumatici montati in singolo 14.00 R25 (385/95 R25).



Sterzo

Doppio circuito, Servoassistito idraulicamente con pompa di emergenza. Assi 1 2 3 e 5 comandati dallo sterzo durante la marcia (steer by wire). Comando separato Sterzata idraulica (steer by wire) gestita elettronicamente per il quarto e il quinto asse per eseguire la sterzata combinata e a granchio.



Freni

Freno di servizio: pneumatico a doppio circuito, agente su tutte le ruote, con essiccatore dell'aria. Freno motore. Freno di parcheggio: con molle precaricate a comando pneumatico agente sugli assi 2,3,4 e 5.



Cabina

In **alluminio**, due posti, cristalli di sicurezza, sedile autista e passeggero con pneumatica sospensione, riscaldamento a ricircolo con il liquido di raffreddamento motore. Completa strumentazione di controllo e guida.



Impianto elettrico

Alternatore trifase 28V/100 A, due batterie 12V 170Ah. Luci e segnali a 24 V.

* Accessori opzionali

- 10x8x10.
- Ritardatore idraulico integrato nella trasmissione.
- Ruote da 16.00 R 25 (445/95 R25).
- Ruote da 20.5 R 25 (525/80 R25). (Larghezza macchina 3,11 metri).
- Cuccetta ribaltabile in cabina.
- Riscaldamento autonomo con preriscaldatore motore.
- Sistema videocamera per retromarcia.

* Altri a richiesta.

Технические характеристики

Крановая установка



Стрела

Шестисекционная стрела TWIN-LOCK™ 13,7 - 64,0 м.
Максимальная высота оголовка стрелы 67,0 м.



Подъем стрелы

1 цилиндр с предохранительным клапаном, угол подъема от -1,5° до +83°.



Ограничитель грузового момента и независимая система блокировки при переподъеме

Ограничитель грузового момента и ограничитель высоты подъема крюка с звуковой и визуальной сигнализацией и блокировкой органов управления. Эти системы выводят на дисплей угол наклона стрелы, длину, радиус, высоту оголовка стрелы, относительный грузовой момент, максимально допустимую нагрузку, текущую нагрузку и предупреждение о возможности перегруза, которое повлечет за собой блокировку управления краном.



Кабина

Кабина: **алюминий**, с круговым обзором, наклоняемая (примерно 20°), безосколочное стекло, регулируемое место оператора с подвеской, устройство для обогрева водой с подогревом от двигателя. Органы управления краном встроены в подлокотник. Эргономичная приборная панель и система управления краном.



Поворот

3 поворотных механизма с аксиально-поршневыми гидравлическими двигателями, планетарной передачей, автоматическим тормозом с ножным управлением поворотом.



Противовес

Закрепленные противовесы: 2 тонны. Гидравлическая система монтажа противовесов.



Двигатель

Mercedes-Benz OM906LA, дизельный, 6-цилиндровый, с водяным охлаждением, с турбонагнетателем, 170кВт (231 л.с.) при 2200 об/мин. (80/1269 EWG - вентилятор без возможности замены). Макс. крутящий момент: 810 Нм при 1200 об/мин. Емкость топливного бака: 240 л. Выбросы двигателя: EUROMOT 3 / EPA / CARB (не дорожный).



Гидравлическая система

2 отдельных контура, 1 аксиально-поршневой насос с переменным рабочим объемом (в зависимости от нагрузки), с электронным ограничителем мощности и 1 насосом со сдвоенной зубчатой передачей для поворота крана. Охладитель масла, регулируемый с помощью термореле. Емкость бака: 915 л.



Система управления

Полностью электронная система управления движением крана с электрорычагами управления и с автоматическим возвратом в нейтральное положение. Эта система соединена с локальным интерфейсом управления и системой управления работой двигателя при помощи шины CAN-BUS. Система ECOS снабжена графическим дисплеем.



Лебедка основного подъема

Аксиально-поршневой гидромотор с планетарной передачей и тормозом. Индикатор вращения барабана.



Электросистема

Трехфазный генератор переменного тока 28 В/80 А, 2 батареи 12 В/170 А-ч.

* Дополнительное оборудование (по выбору)

- Складной удлинитель стрелы 11/18 м, с гидравлическим регулированием вылета стрелы и с возможностью управления под нагрузкой (0° - 40°), управляемый из кабины оператора.
- Удлинитель стрелы, 26/34 м - включает 2 x 8 м промежуточные вставки и 11/18 м Складной удлинитель стрелы (см. выше).
- Встроенный гусек 3,6м., 3 ролика в оголовке. (Макс ГП 38т.)
- Дополнительный противовес 51 т (суммарная масса противовеса 53 т).
- Лебедка вспомогательного подъема.
- Независимое от двигателя устройство для обогрева горячей водой с предварительным нагревом от двигателя.

Тягач



Шасси

Специальное 5-осное шасси: цельносварное, устойчивое к кручению, коробчатого типа, выполненное из высокопрочной стали.



Выносные опоры

4 двойные балки с гидравлическим способом телескопирования с вертикальными цилиндрами и основаниями выносных опор. Независимый контроль горизонтального и вертикального передвижения с каждой стороны тягача и из кабины оператора. Электронный индикатор уровня с автоматической системой выравнивания. Рабочее освещение каждой выносной опоры.



Двигатель

Mercedes-Benz OM502LA, дизельный, 6-цилиндровый, с водяным охлаждением, с турбонагнетателем, 420 кВт (571 л.с.) при 1800 об/мин. (80/1269 EWG - сменный вентилятор). Макс. крутящий момент: 2700 Нм при 1300 об/мин. Емкость топливного бака: 360 л. Выбросы двигателя: EUROMOT / EPA / CARB (не дорожный).



Трансмиссия

Allison automatic HD 4000 SP, 6 передних и 1 задняя передача. Поперечная блокировка дифференциала. Двухступенчатая раздаточная коробка с межосевым механизмом блокировки дифференциала.



Ведущие / Управляемые оси

10 x 6 x 10.



Оси

5 осей. 3, 4 и 5 - ведомые управляемые оси (оси управления поворотом), 1 и 2 - управляемые оси.



Подвеска

MEGATRAK®. Подвеска всех колес гидропневматическая с гидравлической блокировкой. Контроль продольного и поперечного уровня с автоматической системой выравнивания на дороге. Диапазон +160 мм/-120 мм.



Шины

10 шин, 14.00 R25 (385/95 R25).



Рулевое управление

Двухконтурная гидравлическая схема управления поворотами с аварийным насосом системы управления. Оси 1, 2, 3 и 5 управляют движением по дороге (управление при помощи электроники). Раздельное электронное гидравлическое управление 4 и 5 осями для всех управляемых колес.



Тормоза

Рабочая тормозная система: пневматическая двухконтурная, с работой на все колеса, осушитель воздуха. Постоянный тормоз: приспособление для дросселирования выхлопа при торможении двигателем и постоянный дроссельный тормоз.



Кабина

Кабина: **алюминий**, на 2 человека, безосколочное стекло, водительское место с пневматической подвеской, независимое от двигателя устройство подогрева горячей водой. Органы отображения информации и управления краном.



Электросистема

Трехфазный генератор переменного тока 28 В/100А, 2 батареи 12 В/170 А-ч. Система освещения и сигнализации 24 В.

* Дополнительное оборудование (по выбору)

- 10x8x10.
- Гидравлический замедлитель, интегрированный в трансмиссию.
- 10 шин, 16.00 R25 (445/95 R25).
- 10 шин, 20.5 R25 (525/80 R25). (Ширина транспортного средства 3,11 м).
- спальное место в кабине.
- Независимое от двигателя устройство для обогрева горячей водой с предварительным нагревом от двигателя.
- Система обратной камеры.

* Прочее дополнительное оборудование предоставляется по запросу.



Data • Daten • Caractéristiques • Datos • Dati • Данные



Axle • Achse Essieu • Eje Asse • Оси	1	2	3	4	5	Total weight • Gesamtgewicht Poids total • Peso total Peso totale • Суммарный вес
t	12	12	12	12	12	60*

* with 2 t counterweight, or auxiliary hoist, 10x8x10, 16.00 R25 tyres, 11/18 m bi-fold swingaway, 20 t hookblock • mit 2 t Gegengewicht, oder Hilfshubwerk, 10x8x10, 16.00 R25 Reifen, 11/18 m Doppelklappspitze, 20 t Hakenflasche • avec contrepoids de 2 t, ou treuil auxiliaire, 10x8x10, pneus, 16.00 R25, extension treillis 11/18 m, 20 t moufle • con 2 t contrapeso, o cabrestante auxiliar, 10x8x10, neumáticos 16.00 R25, 11/18 m plumin articulado, gancho de 20 t • con a bordo 2 t di zavorra, o argano ausiliario, 10x8x10, Gomme tipo 16.00 R25, falcone ripiegabile da 11/18 m, gancio da 20 t • с противовесом (2 т) или лебедкой дополнительного подъема, 10x8x10, 16.00 R25 шинами, 11/18 м складным удлинителем стрелы, крюковым блоком (20 т).



Lifting Capacity Traglast Force de levage Capacidad de elevación Capacità di sollevamento Грузоподъемность	Sheaves Rollen Poules Poleas Carrucole Шкивы	Weight Gewicht Poids Peso Peso Масса	Parts of line Stränge Brins Ramales de cable Numero di funi Кратность запасовки	Possible load with crane* Mögliche Traglast am Kran* Capacité possible sur la grue* Carga posible con la grue* Portata ammissibile con la gru* Допустимая нагрузка для крана*
200 t	9	2400 kg	2 - 18 / ■19	160 t / 170 t■
160 t	7	1750 kg	2 - 15	135 t
125 t	5	1650 kg	2 - 11	100 t
80 t	3	950 kg	1 - 7	65 t
32 t	1	600 kg	1 - 3	28 t
12 t	H/B	300 kg	1	9,5 t

■ Requires additional boom nose sheave • Zusatzausrüstung am Rollenkopf erforderlich • Demande d'utiliser une poulie auxiliaire de tête de flèche • Requiere polea adicional en la cabeza de pluma • E richiesto un blocco di carrucole ausiliario in testa braccio • требует наличия дополнительного шкива в оголовке стрелы

*Varies depending on national regulations • Variiert je nach Ländvorschrift • Fonction des réglementations nationales • Variaciones dependiendo de las regulaciones nacionales • Varia in funzione delle normative nazionali • изменяется в зависимости от национальных норм

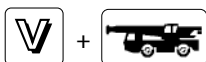



	1	2	3	4	5	6	R	
	19,3	35,4	47,3	67,7	85,0	85,0	14,1	
km/h	19,3	35,4	47,3	67,7	85,0	85,0	14,1	
	8,7	16,0	21,4	30,6	41,3	47,8	6,4	50%
	14.00 R25							

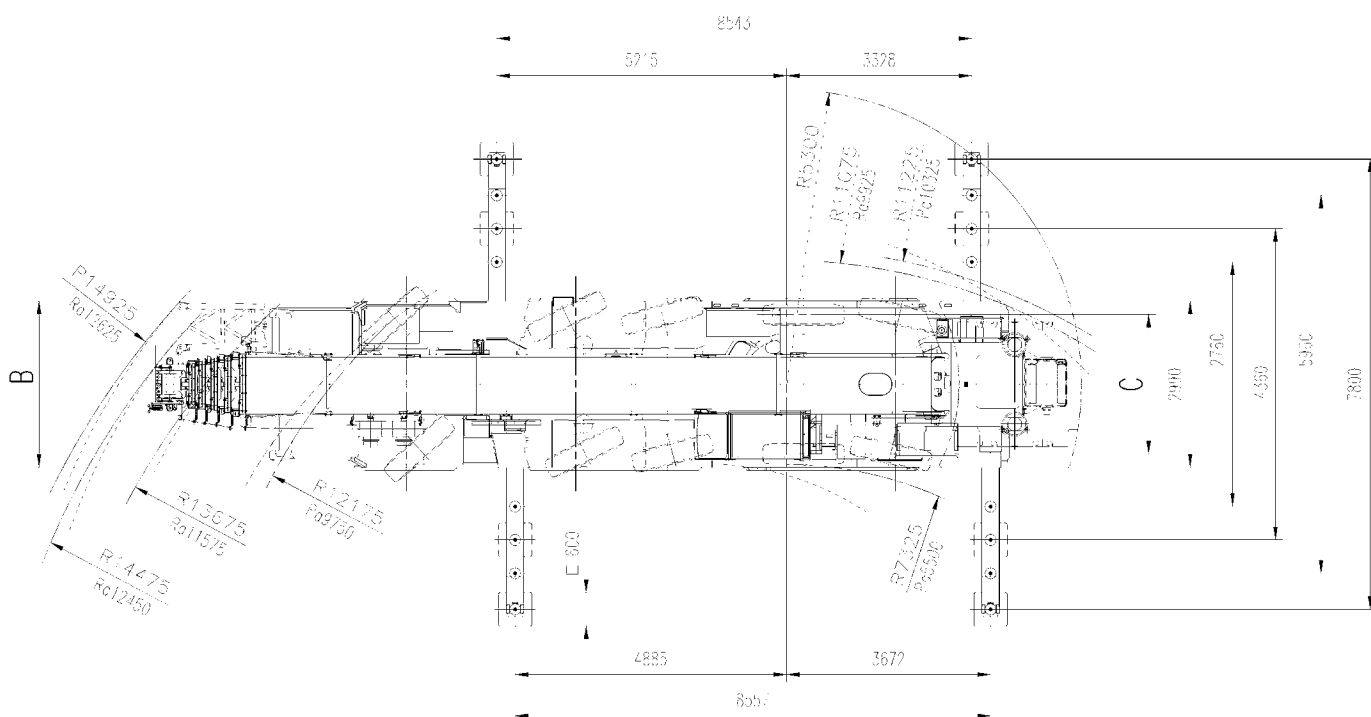
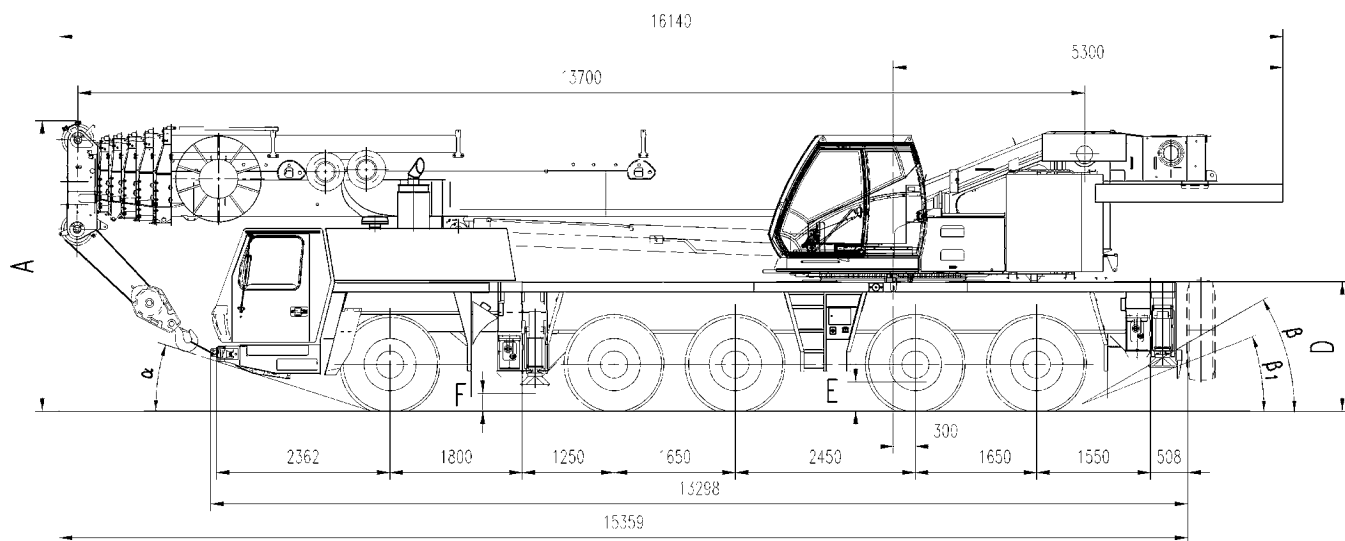

	Infinitely variable • Stufenlos Progressivement variable Infinitamente variable • Infinitamente variabile Плавно-изменяемый	Rope • Seil Câble Cable • Fune Канат	Max. Single line pull • Max. Seilzug Effort maxi au brin simple Tiro máximo por ramal • Tiro max. per singola fune Макс. натяжение каната
	0 - 125 m/min Single line • Einfacher Strang Brin simple • Ramal simple • Tiro a fune singola • Однократная запасовка	22 mm / 290 m	93,0 kN
	0 - 125 m/min Single line • Einfacher Strang Brin simple • Ramal simple • Tiro a fune singola • Однократная запасовка	22 mm / 290 m	93,0 kN
	0 - 1,3 min ⁻¹		
	-1,5° to + 83° approx. 60 s • ca. 60 s env. 60 s • aproximadamente 60 s aproximadamente 60 s • примерно 60 с		
	13,7 to 64,0 m approx. 430 s • ca. 430 s env. 430 s • aproximadamente 430 s aproximadamente 430 s • примерно 430 с		

Dimensions • Abmessungen • Encombrement Dimensiones • Dimensioni • Размеры



	A	A 130 mm*	B	C	D	E	F	α	β	β1
14.00 R25	3950	3820	3000	2548	1760	400	244	18	23	17
16.00 R25	4000	3870	3000	2486	1810	450	295	20	25	19
20.5 R25	4000	3870	3110	2507	1810	450	295	20	25	19

Ra = Radius all wheels steered
 Radius allradgelenkt
 Rayon toutes les roues directrices
 Radio de giro con todas las ruedas giradas
 Raggio di curva con tutte le ruote sterzate
 Радиус поворота при управлении всеми колесами

* Lowered
 Abgesenkt
 Surbassée
 Abbassato
 Rebaja
 Сниженный



Dimensions • Abmessungen • Encombrement
Dimensiones • Dimensioni • Размеры

Counterweight • Gegengewicht • Contrepoids • Contrapesos • Contrappesi • Противовес

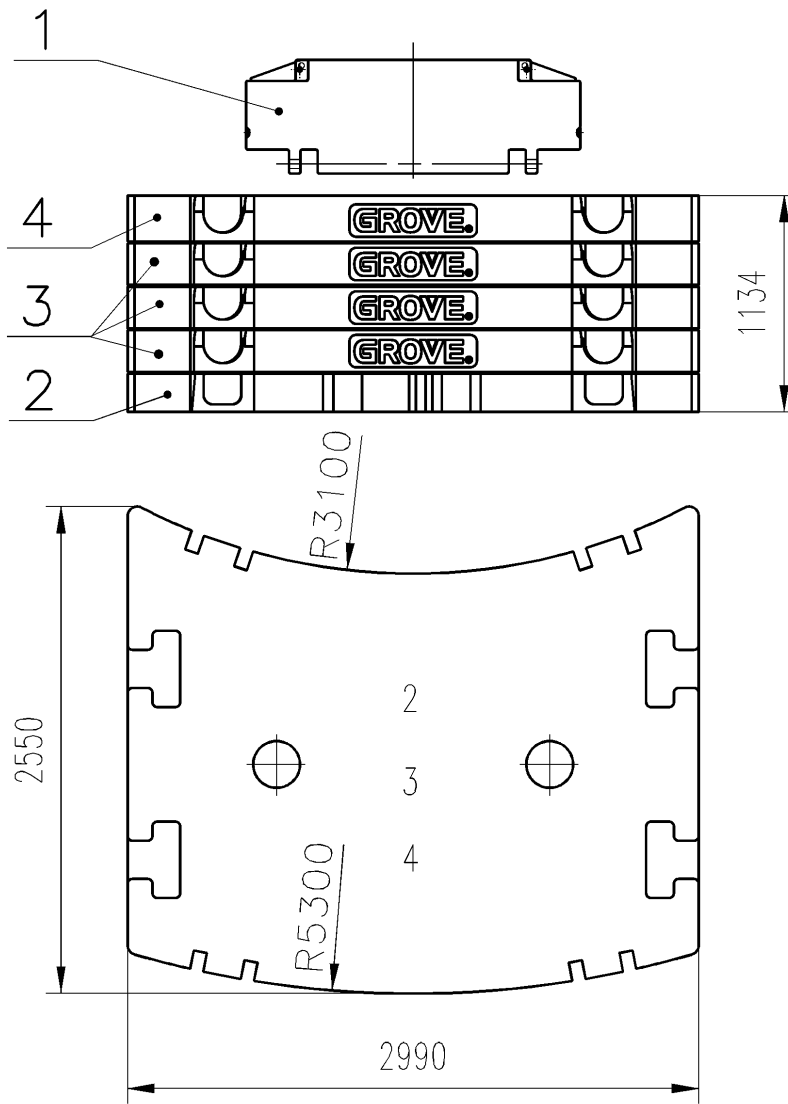

	1 2,0t	2 11,0 t	3 10,0t	4 10,0t*
2,0 t	x	-	-	-
13,0 t	x	x	-	-
23,0 t	X	x	x	-
33,0 t	X	X	2x	-
43,0 t	X	x	3X	-
53,0 t	X	X	3X	x

Dimensions • Abmessungen • Encombrement
Dimensiones • Dimensioni • Размеры

Counterweight • Gegengewicht • Contrepoids • Contrapesos • Contrappesi • Противовес

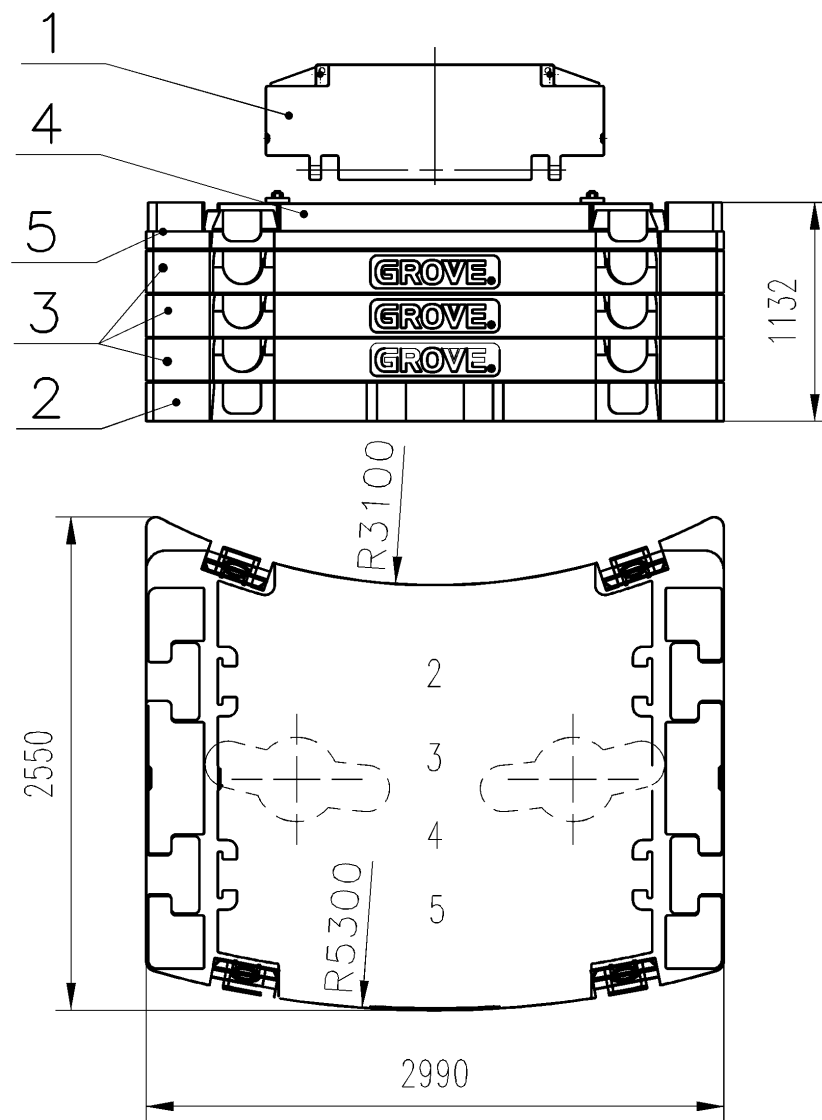

	1 2,0t	2 11,0t	3 10,0t	4 5,0t	5 5,0t
7,0t	x	-	-	x	-
18,0t	x	x	-	x	-
23,0t	x	x	-	x	X
28,0t	X	x	x	x	-
33,0t	X	x	x	x	X
38,0t	X	x	2x	x	-
43,0t	X	x	2x	x	X
48,0t	X	x	3X	x	-
53,0t	X	x	3X	x	X

*Heavy roadable counterweight • Maximal verfahrbares Gegengewicht für Achslasten > 12 t • Contrepoids lourd transportable • Contrapeso pesado que puede transportarse
 Contrappeso pesante trasportabile su strada • Тяжелый противовес, пригодный для транспортировки*



Load charts • Traglasten • Capacités de levage Capacidades • Capacità • Таблицы грузоподъемности

Notes • Hinweise • Notes • Notas • Note • Примечания

The lifting capacities correspond to EN 13000:2004.

The lifting capacities likewise fulfil the requirements of ISO 4305 and DIN 15019, Part 2, with regard to stability, and DIN 15018, Part 3, and FEM 5004 with regard to strength.

The lifting capacities are given in tonnes.

Lifting capacity = Payload + weight of hook block and suspending device.

The lifting capacities for the main boom only apply with the jib dismantled.

Lifting capacities > 125 t require additional equipment.

Lifting capacities > 140 t require special equipment.

The right is reserved to modify the load-carrying capacities.

Note: The details in this brochure serve only as general information. The determinant values for the operation of the crane are the lifting capacity tables belonging to it and the operating instructions.

Die Tragfähigkeiten entsprechen EN 13000:2004.

Die Tragfähigkeitswerte erfüllen ebenfalls die Anforderungen von ISO 4305 und DIN 15019 Teil 2 bezüglich Standsicherheit sowie von DIN 15018 Teil 3 und FEM 5004 bezüglich Festigkeit.

Die Tragfähigkeitswerte sind in Tonnen angegeben.

Tragfähigkeit = Nutzlast + Gewicht der Hakenflasche und Anschlagmittel.

Die Tragfähigkeitswerte für den Hauptausleger gelten nur bei demontierten Spitzenauslegern.

Die Tragfähigkeitswerte > 125 t erfordern eine Zusatzausrüstung.

Die Tragfähigkeitswerte > 140 t erfordern eine Sonderausrüstung.

Änderung der Tragfähigkeiten vorbehalten.

Anmerkung: Die Daten dieser Broschüre dienen nur zur allgemeinen Information. Maßgebend für den Betrieb des Kranes sind die zugehörigen Tragfähigkeitstabellen und die Bedienungsanleitung.

Les capacités de levage sont conformes à la norme EN 13000:2004.

Les capacités de levage respectent également les exigences des normes ISO 4305 et DIN 15019, paragraphe 2, relatives à la stabilité, ainsi que celles des normes DIN 15018 paragraphe 3 et FEM 5004 relatives à la résistance.

Les capacités de levage sont exprimées en tonnes.

Capacité = charge utile + poids du crochet et du dispositif d'élingage.

Les capacités de levage de la flèche principale ne sont valables que lorsque la fléchette est démontée.

Des capacités de levage > 125 tonnes exigent l'utilisation d'un dispositif supplémentaire.

Des capacités de levage > 140 tonnes exigent l'utilisation d'un dispositif spécial.

Le constructeur se réserve le droit d'apporter des modifications à ces capacités de levage.

Remarque : Les données de cette brochure ne sont fournies qu'à titre d'information générale. La manipulation de la grue nécessite l'étude des tableaux de capacité et la lecture des guides d'utilisation correspondants.

Las capacidades de carga corresponden a EN 13000:2004.

Asimismo los valores de carga cumplen las disposiciones de las normas ISO 4305 y DIN 15019, 2.ª parte, respecto a la estabilidad, y DIN 15018, 3.ª parte, y FEM 5004 respecto a la fuerza.

Los valores de carga se dan en toneladas.

Capacidad de carga = Carga + peso de la garrucha del gancho y del mecanismo de elevación.

Los valores de carga para la pluma principal sólo son válidos cuando no hay plumines instalados.

Valores de carga > 125 t requieren un mecanismo de elevación suplementario.

Valores de carga > 140 t requieren una unidad especial.

Se reserva el derecho a modificar las capacidades de carga.

Nota: Los detalles contenidos en este folleto sirven sólo como información general. Los valores determinantes para el funcionamiento de la grúa son los cuadros de cargas correspondientes, así como las instrucciones de funcionamiento.

Le tabelle di portata sono conformi alle norme EN 13000:2004.

I valori delle tabelle di portata sono conformi anche ai requisiti delle norme ISO 4305 e DIN 15019, Parte 2, per quanto riguarda la stabilità, ed alle norme DIN 15018, Parte 3, e FEM 5004 per quanto riguarda il calcolo di resistenza della struttura.

I valori di portata sono indicati in tonnellate.

Capacità di portata = carico utile + peso del gancio e accessori di sollevamento.

I valori delle tabelle di portata per il braccio principale si applicano solo con le punte bracci smontate.

Valori di portata > 125 t richiedono un'attrezzatura supplementare.

Valori di portata > 140 t richiedono un'unità speciale.

Si riserva il diritto di modificare i valori di portata.

Nota: i dettagli forniti nel presente opuscolo servono solo come informazioni di carattere generale. I valori determinanti per il funzionamento della gru sono le tabelle di portata appartenenti alla gru stessa e le istruzioni di funzionamento.

Грузоподъемность соответствует EN 13000:2004.

Кроме того, грузоподъемность удовлетворяет требованиям ISO 4305 и DIN 15019 (часть 2) в отношении устойчивости, и DIN 15018, (часть 3), и FEM 5004 в отношении прочности материала.

Грузоподъемность приведена в тоннах.

Грузоподъемность = Полезный груз + вес крюкового блока и устройства для подвешивания.

Грузоподъемность основной стрелы только при сложенном удлинителе.

Грузоподъемность > 125 т необходимо дополнительное оборудование.

Грузоподъемность > 140 т необходимо специальное оборудование.

Оставляем за собой право изменять грузоподъемность.

Примечание: В данной брошюре приведена только общая информация. Рабочие значения для крана приведены в таблицах грузоподъемности (см. данную брошюру и инструкции по эксплуатации).

Load charts • Traglasten • Capacités de levage Capacidades • Capacità • Таблицы грузоподъемности

Overview • Übersicht • Tableau synoptique • Resumen de las tablas • Tabella riassuntiva • Общие сведения



13,7 – 64,0 m



360°



8,55 x 7,80 m



8,55 x 5,96 m



8,55 x 4,36 m



8,55 x 2,76 m

m	t	53	48	43	38	33	28	23	18	13	7	2	38	33	28	23	18	13	7	2	13	7	2	2
13,70		•	•	•	•	•	•	•	•	•	•	•	•	•	•	•	•	•	•	•	•	•	•	•
18,80		•	•	•	•	•	•	•	•	•	•	•	•	•	•	•	•	•	•	•	•	•	•	•
23,87		•	•	•	•	•	•	•	•	•	•	•	•	•	•	•	•	•	•	•	•	•	•	•
28,90		•	•	•	•	•	•	•	•	•	•	•	•	•	•	•	•	•	•	•	•	•	•	•
33,91		•	•	•	•	•	•	•	•	•	•	•	•	•	•	•	•	•	•	•	•	•	•	•
38,85		•	•	•	•	•	•	•	•	•	•	•	•	•	•	•	•	•	•	•	•	•	•	•
43,95		•	•	•	•	•	•	•	•	•	•	•	•	•	•	•	•	•	•	•	•	•	•	•
49,02		•	•	•	•	•	•	•	•	•	•	•	•	•	•	•	•	•	•	•	•	•	•	•
54,05		•	•	•	•	•	•	•	•	•	•	•	•	•	•	•	•	•	•	•	•	•	•	•
59,06		•	•	•	•	•	•	•	•	•	•	•	•	•	•	•	•	•	•	•	•	•	•	•
64,00		•	•	•	•	•	•	•	•	•	•	•	•	•	•	•	•	•	•	•	•	•	•	•



0°-40°

3,6-11,0-18,0-26,0-34,0 m



8,55 x 7,80 m



360°



53 t



43 t



33 t



23 t



13 t



7 t

m	m	11	18	26	34	11	18	26	34	11	18	26	34	11	18	26	34	11	18	26	34	11	18	
38,85		•	•	•	•	•	•	•	•	•	•	•	•	•	•	•	•	•	•	•	•	•	•	•
43,95		•	•	•	•	•	•	•	•	•	•	•	•	•	•	•	•	•	•	•	•	•	•	•
49,02		•	•	•	•	•	•	•	•	•	•	•	•	•	•	•	•	•	•	•	•	•	•	•
54,05		•	•	•	•	•	•	•	•	•	•	•	•	•	•	•	•	•	•	•	•	•	•	•
59,06		•	•	•	•	•	•	•	•	•	•	•	•	•	•	•	•	•	•	•	•	•	•	•
64,00		•	•	•	•	•	•	•	•	•	•	•	•	•	•	•	•	•	•	•	•	•	•	•



0°-40°

3,6-11,0-18,0-26,0-34,0 m



8,55 x 5,96 m



360°



33 t



23 t



13 t

m	m	11	18	26	34	11	18	26	34	11	18
38,85		•	•	•	•	•	•	•	•	•	•
43,95		•	•	•	•	•	•	•	•	•	•
49,02		•	•	•	•	•	•	•	•	•	•
54,05		•	•	•	•	•	•	•	•	•	•
59,06		•	•	•	•	•	•	•	•	•	•
64,00		•	•	•	•	•	•	•	•	•	•



Load charts • Traglasten • Capacités de levage Capacidades • Capacità • Таблицы грузоподъемности

Working range • Arbeitsbereiche • Diagramme de levage • Gama de trabajo • Area di lavoro • Грузовысотные характеристики



13,7 – 64,0 m



7,8 m



360°

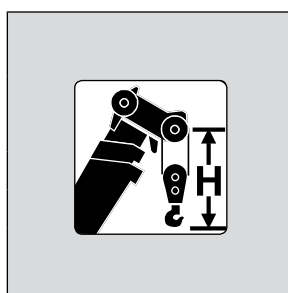
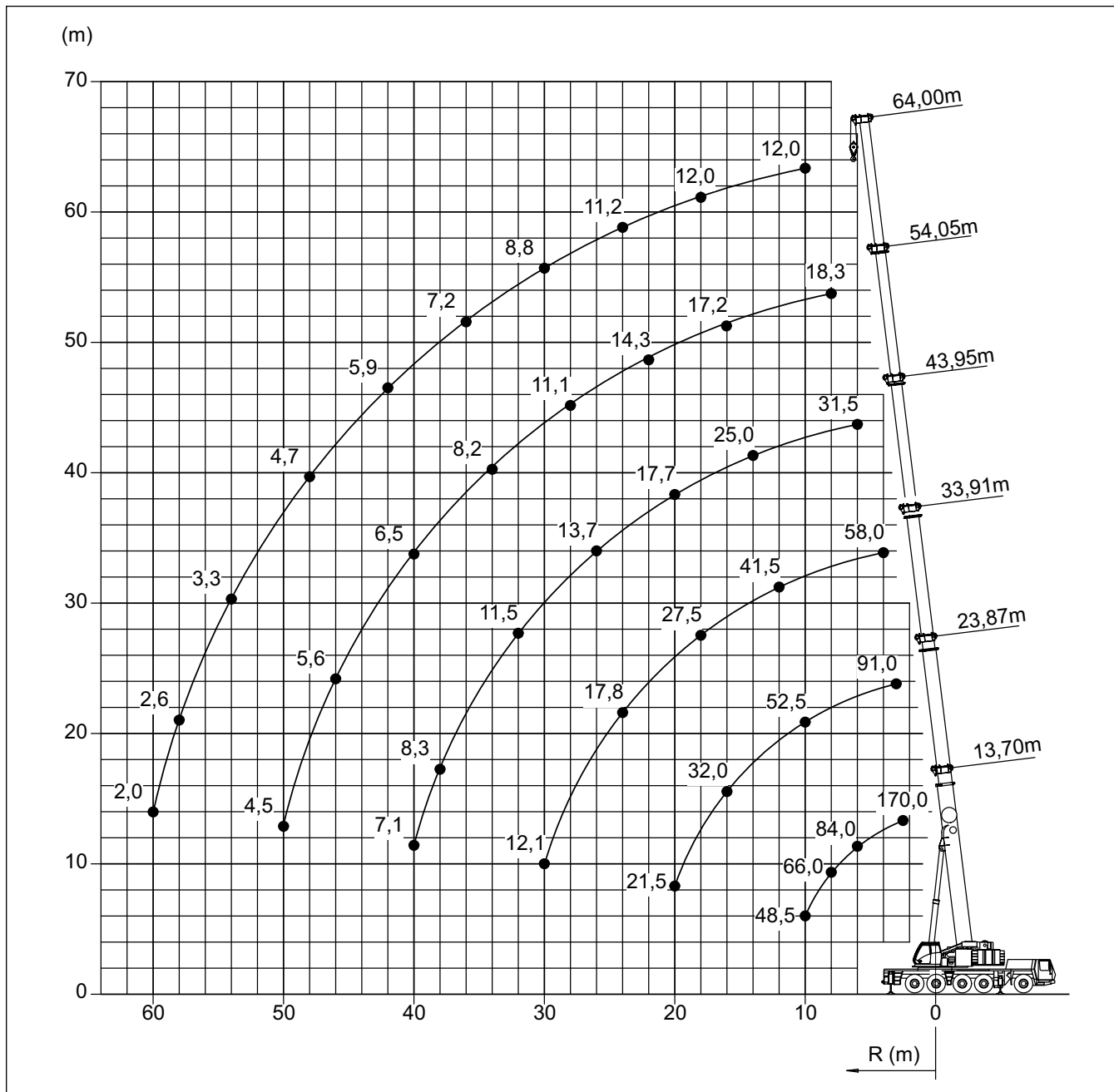

Hook block • Hakenflasche • Crochet-moufle • Gancho • Ganci • Крюковой блок (t)	H (mm)
200 D	3650
160 D	3650
125 D	3300
80 D	3300
32 E	3200
12 H/B	2450

Load charts • Traglasten • Capacités de levage Capacidades • Capacità • Таблицы грузоподъемности

Telescopic boom • Teleskopausleger • Flèche principale • Pluma telescópica • Braccio telescopico • Телескопическая стрела



13,7 - 64,0 m



7,8 m



360°



53,1 t



EN 13000





m	13,70*	13,70	18,80	23,87	28,90	33,91	38,85	43,95	49,02	54,05	59,06	64,00
2,5	170,0/140,0	-	-	-	-	-	-	-	-	-	-	-
3,0	125,0	125,0	102,0	91,0	76,0	-	-	-	-	-	-	-
4,0	109,0	109,0	95,5	84,5	75,5	58,0	-	-	-	-	-	-
5,0	95,0	94,5	91,5	78,0	70,5	58,0	44,0	-	-	-	-	-
6,0	84,0	82,5	82,0	74,0	66,5	58,0	44,0	31,5	-	-	-	-
7,0	74,5	72,5	73,5	70,0	63,0	56,5	43,5	31,5	24,0	-	-	-
8,0	66,0	65,0	65,5	63,5	60,5	53,0	42,5	31,5	24,0	18,3	-	-
9,0	58,0	58,0	59,0	57,5	57,0	50,5	40,5	31,5	23,5	18,3	14,6	-
10,0	48,5	48,5	53,5	52,5	52,5	47,0	38,5	31,5	23,5	18,3	14,6	12,0
11,0	-	-	49,0	47,5	48,5	44,5	37,0	30,5	23,5	18,2	14,5	12,0
12,0	-	-	45,0	43,5	44,5	41,5	35,0	28,5	23,0	18,2	14,5	12,0
13,0	-	-	41,0	41,0	41,0	39,5	33,5	27,0	22,5	17,9	14,5	12,0
14,0	-	-	36,5	38,5	37,5	37,5	32,0	25,0	22,0	17,7	14,5	12,0
15,0	-	-	31,0	35,0	34,0	35,5	30,5	23,5	21,0	17,4	14,5	12,0
16,0	-	-	-	32,0	31,5	32,5	29,5	22,5	20,5	17,2	14,5	12,0
18,0	-	-	-	27,5	26,5	27,5	26,5	20,0	18,4	16,2	14,0	12,0
20,0	-	-	-	21,5	23,5	23,0	24,0	17,7	16,9	15,2	13,4	12,0
22,0	-	-	-	-	20,5	19,7	20,5	16,2	15,4	14,3	12,8	11,7
24,0	-	-	-	-	17,7	17,8	17,9	14,7	14,1	13,2	12,1	11,2
26,0	-	-	-	-	-	16,4	15,7	13,7	12,8	12,1	11,4	10,5
28,0	-	-	-	-	-	14,5	13,8	12,8	11,8	11,1	10,6	9,7
30,0	-	-	-	-	-	12,1	12,2	12,1	10,8	10,2	9,9	8,8
32,0	-	-	-	-	-	-	10,8	11,5	10,0	8,8	8,5	8,3
34,0	-	-	-	-	-	-	9,9	10,3	8,9	8,2	7,9	7,7
36,0	-	-	-	-	-	-	-	9,2	7,9	7,5	7,3	7,2
38,0	-	-	-	-	-	-	-	8,3	7,3	7,0	6,8	6,8
40,0	-	-	-	-	-	-	-	7,1	6,9	6,5	6,3	6,3
42,0	-	-	-	-	-	-	-	-	6,6	6,1	5,9	5,9
44,0	-	-	-	-	-	-	-	-	6,4	5,9	5,4	5,5
46,0	-	-	-	-	-	-	-	-	-	5,6	4,9	5,1
48,0	-	-	-	-	-	-	-	-	-	5,3	4,6	4,7
50,0	-	-	-	-	-	-	-	-	-	4,5	4,3	4,2
52,0	-	-	-	-	-	-	-	-	-	-	4,1	3,7
54,0	-	-	-	-	-	-	-	-	-	-	3,8	3,3
56,0	-	-	-	-	-	-	-	-	-	-	-	2,9
58,0	-	-	-	-	-	-	-	-	-	-	-	2,6
60,0	-	-	-	-	-	-	-	-	-	-	-	2,0



* Over rear • Nach hinten • En arrière • Por la parte trasera • Sul posteriore • Над задней частью



Load charts • Traglasten • Capacités de levage Capacidades • Capacità • Таблицы грузоподъемности

Telescopic boom • Teleskopausleger • Flèche principale • Pluma telescópica • Braccio telescopico • Телескопическая стрела





 13,7 - 64,0 m
  7,8 m
  360°
  43,1 t

  EN 13000

m	13,70	18,80	23,87	28,90	33,91	38,85	43,95	-49,02	54,05	59,06	64,00
3,0	125,0	102,0	91,0	76,0	-	-	-	-	-	-	-
4,0	108,0	95,5	84,5	75,5	58,0	-	-	-	-	-	-
5,0	92,5	91,5	78,0	70,5	58,0	44,0	-	-	-	-	-
6,0	80,5	81,0	74,0	66,5	58,0	44,0	31,5	-	-	-	-
7,0	71,0	72,0	70,0	63,0	56,5	43,5	31,5	24,0	-	-	-
8,0	63,5	64,0	63,0	60,5	53,0	42,5	31,5	24,0	18,3	-	-
9,0	57,5	58,0	56,5	57,0	50,5	40,5	31,5	23,5	18,3	14,6	-
10,0	48,5	52,5	51,0	52,0	47,0	38,5	31,5	23,5	18,3	14,6	12,0
11,0	-	47,5	46,5	47,0	44,5	37,0	30,5	23,5	18,2	14,5	12,0
12,0	-	42,5	42,5	42,0	41,5	35,0	28,5	23,0	18,2	14,5	12,0
13,0	-	38,5	38,5	37,5	38,5	33,5	27,0	22,5	17,9	14,5	12,0
14,0	-	35,0	35,0	34,0	34,5	32,0	25,0	22,0	17,7	14,5	12,0
15,0	-	31,0	31,5	30,5	31,5	30,5	23,5	21,0	17,4	14,5	12,0
16,0	-	-	28,0	29,0	28,5	29,0	22,5	20,5	17,2	14,5	12,0
18,0	-	-	24,0	24,0	23,5	24,0	20,0	18,4	16,2	14,0	12,0
20,0	-	-	20,5	20,0	21,0	20,5	17,7	16,9	15,2	13,4	12,0
22,0	-	-	-	18,0	18,0	17,3	16,2	15,4	14,3	12,8	11,7
24,0	-	-	-	16,0	15,6	14,8	14,5	14,1	13,2	12,1	11,2
26,0	-	-	-	-	13,6	12,8	13,5	12,2	12,1	11,4	10,5
28,0	-	-	-	-	11,9	11,6	11,9	10,5	10,8	10,6	9,7
30,0	-	-	-	-	10,5	11,0	10,5	9,5	9,4	9,8	8,8
32,0	-	-	-	-	-	10,0	9,2	8,5	8,2	8,5	8,3
34,0	-	-	-	-	-	8,9	8,2	8,1	7,7	7,5	7,7
36,0	-	-	-	-	-	-	7,3	7,6	7,2	6,7	7,0
38,0	-	-	-	-	-	-	6,6	6,8	6,9	6,3	6,2
40,0	-	-	-	-	-	-	6,3	6,1	6,2	5,9	5,5
42,0	-	-	-	-	-	-	-	5,5	5,5	5,3	4,8
44,0	-	-	-	-	-	-	-	5,3	5,0	4,7	4,2
46,0	-	-	-	-	-	-	-	-	4,4	4,2	3,7
48,0	-	-	-	-	-	-	-	-	4,1	3,7	3,2
50,0	-	-	-	-	-	-	-	-	3,8	3,3	2,8
52,0	-	-	-	-	-	-	-	-	-	2,9	2,4
54,0	-	-	-	-	-	-	-	-	-	2,6	2,1
56,0	-	-	-	-	-	-	-	-	-	-	1,7
58,0	-	-	-	-	-	-	-	-	-	-	1,4
60,0	-	-	-	-	-	-	-	-	-	-	1,1





Load charts • Traglasten • Capacités de levage Capacidades • Capacità • Таблицы грузоподъемности

Telescopic boom • Teleskopausleger • Flèche principale • Pluma telescópica • Braccio telescopico • Телескопическая стрела

 13,7 - 64,0 m
  7,8 m
  360°
  33,1 t

  EN 13000

m	13,70	18,80	23,87	28,90	33,91	38,85	43,95	49,02	54,05	59,06	64,00
3,0	125,0	102,0	91,0	76,0	-	-	-	-	-	-	-
4,0	106,0	95,5	84,5	75,5	58,0	-	-	-	-	-	-
5,0	90,5	90,5	78,0	70,5	58,0	44,0	-	-	-	-	-
6,0	79,0	79,5	74,0	66,5	58,0	44,0	31,5	-	-	-	-
7,0	70,0	70,5	70,0	63,0	56,5	43,5	31,5	24,0	-	-	-
8,0	62,5	63,0	63,5	60,5	53,0	42,5	31,5	24,0	18,3	-	-
9,0	55,0	56,0	56,5	54,5	50,5	40,5	31,5	23,5	18,3	14,6	-
10,0	48,0	49,0	50,0	46,5	45,5	38,5	31,5	23,5	18,3	14,6	12,0
11,0	-	43,5	44,5	40,5	40,0	37,0	30,5	23,5	18,2	14,5	12,0
12,0	-	38,5	38,5	36,0	35,5	35,0	28,5	23,5	18,2	14,5	12,0
13,0	-	33,0	33,5	32,0	31,5	31,5	27,0	23,5	17,9	14,5	12,0
14,0	-	29,0	29,5	28,0	28,5	28,5	25,0	23,5	17,7	14,5	12,0
15,0	-	25,5	26,0	25,0	25,5	26,0	23,5	21,0	17,4	14,5	12,0
16,0	-	-	23,5	22,0	25,0	23,5	22,0	20,5	17,2	14,5	12,0
18,0	-	-	19,0	17,7	20,5	19,8	18,5	17,9	16,2	14,0	12,0
20,0	-	-	15,8	14,4	17,2	16,4	16,6	15,2	15,1	13,4	12,0
22,0	-	-	-	11,8	14,5	14,3	14,5	13,0	12,9	12,8	11,7
24,0	-	-	-	9,8	12,4	13,2	12,4	11,6	11,4	11,3	11,2
26,0	-	-	-	-	10,7	11,5	10,7	10,8	10,6	10,2	10,1
28,0	-	-	-	-	10,1	10,0	9,3	9,7	9,8	9,2	8,8
30,0	-	-	-	-	9,2	8,8	8,2	8,4	8,5	8,3	7,7
32,0	-	-	-	-	-	7,7	7,7	7,5	7,5	7,3	6,8
34,0	-	-	-	-	-	6,9	7,1	7,0	6,6	6,4	5,8
36,0	-	-	-	-	-	-	6,4	6,3	6,0	5,6	5,1
38,0	-	-	-	-	-	-	5,7	5,6	5,3	4,9	4,4
40,0	-	-	-	-	-	-	5,0	5,0	4,7	4,2	3,7
42,0	-	-	-	-	-	-	-	4,4	4,1	3,7	3,2
44,0	-	-	-	-	-	-	-	3,9	3,6	3,2	2,7
46,0	-	-	-	-	-	-	-	-	3,2	2,7	2,2
48,0	-	-	-	-	-	-	-	-	2,8	2,3	1,8
50,0	-	-	-	-	-	-	-	-	2,4	2,0	1,4
52,0	-	-	-	-	-	-	-	-	-	1,6	1,1
54,0	-	-	-	-	-	-	-	-	-	1,3	-

 13,7 - 64,0 m
  7,8 m
  360°
  23,1 t





  EN 13000



m	13,70	18,80	23,87	28,90	33,91	38,85	43,95	49,02	54,05	59,06	64,00
3,0	124,0	102,0	91,0	76,0	-	-	-	-	-	-	-
4,0	104,0	95,5	84,5	75,5	58,0	-	-	-	-	-	-
5,0	89,0	89,0	78,0	70,5	58,0	44,0	-	-	-	-	-
6,0	77,5	78,0	74,0	66,5	58,0	44,0	31,5	-	-	-	-
7,0	68,0	69,0	67,0	63,0	56,5	43,5	31,5	24,0	-	-	-
8,0	57,5	58,5	57,5	52,0	50,0	42,5	31,5	24,0	18,3	-	-
9,0	49,5	50,5	47,5	43,5	42,5	40,5	31,5	23,5	18,3	14,6	-
10,0	42,0	43,0	40,5	37,0	37,0	36,0	31,5	23,5	18,3	14,6	12,0
11,0	-	36,0	35,0	32,0	34,5	31,5	29,0	23,5	18,2	14,5	12,0
12,0	-	30,5	30,5	28,0	30,5	28,0	26,0	23,0	18,2	14,5	12,0
13,0	-	26,0	26,0	24,5	27,0	25,0	23,0	22,0	17,9	14,5	12,0
14,0	-	23,0	23,0	22,0	24,5	22,5	21,5	19,9	17,7	14,5	12,0
15,0	-	20,0	20,0	19,2	22,0	20,5	20,5	17,9	17,4	14,5	12,0
16,0	-	-	17,6	16,9	19,9	18,4	18,6	16,2	16,0	14,5	12,0
18,0	-	-	14,0	13,2	16,1	16,7	15,6	14,4	14,4	13,8	12,0
20,0	-	-	11,2	10,5	13,4	14,1	13,2	13,3	13,1	12,4	11,4
22,0	-	-	-	8,4	12,3	11,9	11,4	11,5	11,4	10,6	9,7
24,0	-	-	-	6,7	10,5	10,1	10,4	10,4	10,0	9,2	8,3
26,0	-	-	-	-	9,0	8,7	9,0	8,9	8,6	7,9	7,1
28,0	-	-	-	-	7,8	7,8	7,7	7,7	7,4	6,9	6,0
30,0	-	-	-	-	6,8	7,1	6,9	6,7	6,4	5,9	5,2
32,0	-	-	-	-	-	6,2	6,0	5,8	5,5	5,0	4,4
34,0	-	-	-	-	-	5,5	5,3	5,0	4,7	4,3	3,7
36,0	-	-	-	-	-	-	4,6	4,3	4,0	3,6	3,1
38,0	-	-	-	-	-	-	4,0	3,8	3,5	3,0	2,5
40,0	-	-	-	-	-	-	3,5	3,2	2,9	2,5	2,0
42,0	-	-	-	-	-	-	-	2,8	2,5	2,0	1,5
44,0	-	-	-	-	-	-	-	2,4	2,0	1,6	1,1
46,0	-	-	-	-	-	-	-	-	1,7	1,2	-
48,0	-	-	-	-	-	-	-	-	1,3	0,9	-
50,0	-	-	-	-	-	-	-	-	1,0	-	-







Load charts • Traglasten • Capacités de levage Capacidades • Capacità • Таблицы грузоподъемности



Telescopic boom • Teleskopausleger • Flèche principale • Pluma telescópica • Braccio telescopico • Телескопическая стрела

 13,7 - 64,0 m
  7,8 m
  360°
  18,1 t

  EN 13000

m	13,70	18,80	23,87	28,90	33,91	38,85	43,95	49,02	54,05	59,06	64,00
3,0	122,0	102,0	91,0	76,0	-	-	-	-	-	-	-
4,0	103,0	95,5	84,5	75,5	58,0	-	-	-	-	-	-
5,0	88,0	88,5	78,0	70,5	58,0	44,0	-	-	-	-	-
6,0	76,5	77,0	74,0	66,5	58,0	44,0	31,5	-	-	-	-
7,0	64,5	65,5	62,5	56,0	53,5	43,5	31,5	24,0	-	-	-
8,0	54,5	55,5	50,5	48,5	44,0	42,5	31,5	24,0	18,3	-	-
9,0	44,5	46,0	44,0	41,0	39,5	36,5	31,5	23,5	18,3	14,6	-
10,0	37,0	39,0	37,5	35,0	34,5	31,5	29,0	23,5	18,3	14,6	12,0
11,0	-	32,5	32,5	32,0	30,0	27,5	25,5	23,5	18,2	14,5	12,0
12,0	-	28,0	28,0	28,5	26,5	24,5	24,0	21,5	18,2	14,5	12,0
13,0	-	24,5	24,5	25,5	23,5	21,5	22,0	19,1	17,9	14,5	12,0
14,0	-	21,5	22,5	22,5	21,5	20,5	19,6	17,4	16,7	14,5	12,0
15,0	-	18,7	19,8	19,9	19,2	19,2	17,7	16,5	16,2	14,5	12,0
16,0	-	-	17,6	17,8	17,3	17,7	16,1	15,7	15,6	14,2	12,0
18,0	-	-	14,2	14,3	14,6	14,8	13,5	13,7	13,4	12,4	11,4
20,0	-	-	11,9	11,7	12,6	12,2	12,4	12,1	11,4	10,5	9,5
22,0	-	-	-	10,6	10,6	10,4	10,6	10,4	9,8	8,9	8,0
24,0	-	-	-	9,0	9,0	9,3	9,1	8,9	8,4	7,6	6,7
26,0	-	-	-	-	7,6	8,0	7,8	7,5	7,2	6,4	5,6
28,0	-	-	-	-	6,8	6,9	6,7	6,4	6,1	5,5	4,7
30,0	-	-	-	-	5,9	5,9	5,7	5,5	5,2	4,6	3,9
32,0	-	-	-	-	-	5,1	4,9	4,7	4,4	3,9	3,2
34,0	-	-	-	-	-	4,4	4,2	4,0	3,7	3,2	2,5
36,0	-	-	-	-	-	-	3,6	3,4	3,1	2,6	2,0
38,0	-	-	-	-	-	-	3,1	2,8	2,5	2,1	1,5
40,0	-	-	-	-	-	-	2,7	2,4	2,1	1,6	1,0
42,0	-	-	-	-	-	-	-	2,0	1,6	1,2	-
44,0	-	-	-	-	-	-	-	1,6	1,3	-	-
46,0	-	-	-	-	-	-	-	-	0,9	-	-

 13,7 - 64,0 m
  7,8 m
  360°
  13,1 t

  EN 13000

m	13,70	18,80	23,87	28,90	33,91	38,85	43,95	49,02	54,05	59,06	64,00
3,0	121,0	102,0	91,0	76,0	-	-	-	-	-	-	-
4,0	102,0	95,5	84,5	75,5	58,0	-	-	-	-	-	-
5,0	87,0	87,5	78,0	70,5	58,0	44,0	-	-	-	-	-
6,0	74,0	75,0	71,0	62,5	58,0	44,0	31,5	-	-	-	-
7,0	61,0	60,5	54,5	52,0	46,5	43,5	31,5	24,0	-	-	-
8,0	48,5	49,5	46,0	42,5	41,0	37,5	31,5	24,0	18,3	-	-
9,0	39,0	41,0	38,5	36,5	35,0	31,5	29,0	23,5	18,3	14,6	-
10,0	31,5	34,0	32,5	32,5	30,0	27,5	26,5	23,5	18,3	14,6	12,0
11,0	-	29,0	28,0	28,0	26,0	24,0	23,5	20,5	18,2	14,5	12,0
12,0	-	24,5	25,5	24,5	23,0	23,0	21,0	19,1	17,7	14,5	12,0
13,0	-	21,0	22,0	22,0	20,5	20,5	18,6	18,2	17,2	14,5	12,0
14,0	-	18,2	19,3	19,5	18,2	18,4	16,7	16,5	16,1	14,3	12,0
15,0	-	15,9	17,0	17,1	16,9	16,6	15,5	15,8	14,9	13,7	12,0
16,0	-	-	15,1	15,2	16,0	15,1	14,7	14,4	13,5	12,4	11,3
18,0	-	-	12,3	12,8	13,0	12,5	12,8	12,0	11,2	10,3	9,3
20,0	-	-	10,0	10,7	10,7	11,1	10,8	10,1	9,4	8,6	7,6
22,0	-	-	-	8,9	8,9	9,2	9,0	8,6	8,0	7,1	6,3
24,0	-	-	-	7,5	7,7	7,8	7,6	7,3	6,7	6,0	5,1
26,0	-	-	-	-	6,5	6,6	6,4	6,1	5,7	5,0	4,1
28,0	-	-	-	-	5,5	5,6	5,4	5,1	4,8	4,1	3,3
30,0	-	-	-	-	4,7	4,7	4,5	4,3	4,0	3,3	2,6
32,0	-	-	-	-	-	4,0	3,8	3,6	3,3	2,7	2,0
34,0	-	-	-	-	-	3,4	3,2	2,9	2,7	2,1	1,4
36,0	-	-	-	-	-	-	2,7	2,4	2,1	1,6	0,9
38,0	-	-	-	-	-	-	2,2	1,9	1,6	1,2	-
40,0	-	-	-	-	-	-	1,8	1,5	1,2	-	-
42,0	-	-	-	-	-	-	-	1,2	-	-	-

Load charts • Traglasten • Capacités de levage Capacidades • Capacità • Таблицы грузоподъемности

Telescopic boom • Teleskopausleger • Flèche principale • Pluma telescópica • Braccio telescopico • Телескопическая стрела



13,7 - 64,0 m



7,8 m



360°



7,1 t



EN 13000

m	13,70	18,80	23,87	28,90	33,91	38,85	43,95	49,02	54,05	59,06	64,00
3,0	120,0	102,0	91,0	76,0	-	-	-	-	-	-	-
4,0	100,0	95,5	84,5	75,5	58,0	-	-	-	-	-	-
5,0	86,0	86,5	78,0	70,0	58,0	44,0	-	-	-	-	-
6,0	69,0	67,0	59,0	55,0	48,5	44,0	31,5	-	-	-	-
7,0	53,0	52,0	48,0	43,0	41,5	37,5	31,5	24,0	-	-	-
8,0	40,5	41,0	38,5	37,5	34,5	31,0	29,0	24,0	18,3	-	-
9,0	32,0	34,0	32,5	31,5	29,0	27,0	25,5	22,0	18,3	14,6	-
10,0	26,0	29,0	28,5	27,0	24,5	24,5	22,0	21,0	18,3	14,6	12,0
11,0	-	24,0	24,5	23,0	21,5	21,5	19,3	18,9	17,5	14,5	12,0
12,0	-	20,0	21,0	20,0	20,0	18,8	18,1	17,6	16,4	14,3	12,0
13,0	-	17,0	18,2	17,8	18,1	16,7	16,7	15,7	14,7	13,4	12,0
14,0	-	14,6	16,0	15,8	16,1	15,1	15,0	14,1	13,1	12,0	10,8
15,0	-	12,6	14,0	14,8	14,5	14,3	13,5	12,6	11,8	10,7	9,6
16,0	-	-	12,3	13,1	13,1	13,0	12,2	11,4	10,6	9,6	8,6
18,0	-	-	9,7	10,4	10,7	10,7	10,1	9,4	8,7	7,8	6,8
20,0	-	-	7,7	8,4	8,7	8,8	8,4	7,8	7,1	6,3	5,4
22,0	-	-	-	6,9	7,1	7,2	7,0	6,4	5,9	5,1	4,2
24,0	-	-	-	5,6	5,8	5,9	5,7	5,3	4,8	4,0	3,2
26,0	-	-	-	-	4,8	4,9	4,7	4,4	3,9	3,2	2,4
28,0	-	-	-	-	4,0	4,0	3,9	3,6	3,1	2,4	1,7
30,0	-	-	-	-	3,3	3,3	3,1	2,9	2,5	1,8	1,1
32,0	-	-	-	-	-	2,7	2,5	2,3	1,9	1,2	-
34,0	-	-	-	-	-	2,2	2,0	1,7	1,4	-	-
36,0	-	-	-	-	-	-	1,5	1,3	0,9	-	-
38,0	-	-	-	-	-	-	1,1	0,9	-	-	-



13,7 - 64,0 m



7,8 m



360°



2,1 t



EN 13000

m	13,70	18,80	23,87	28,90	33,91	38,85	43,95	49,02	54,05	59,06	64,00
3,0	119,0	102,0	91,0	76,0	-	-	-	-	-	-	-
4,0	99,0	95,5	84,5	75,5	58,0	-	-	-	-	-	-
5,0	81,5	80,5	69,0	62,5	53,5	44,0	-	-	-	-	-
6,0	62,5	57,5	52,0	46,0	44,0	38,5	31,5	-	-	-	-
7,0	44,0	43,0	40,0	38,5	35,0	31,0	30,0	24,0	-	-	-
8,0	33,5	35,0	33,5	31,5	28,5	28,0	25,0	22,5	18,3	-	-
9,0	26,0	28,5	28,0	26,0	24,5	23,5	21,5	20,5	17,5	14,6	-
10,0	20,5	24,0	23,5	22,0	22,0	20,0	19,9	18,5	16,8	14,3	12,0
11,0	-	19,5	20,0	19,2	19,0	18,4	17,4	16,2	15,0	13,6	12,0
12,0	-	16,2	17,6	17,6	16,7	16,3	15,3	14,2	13,2	11,9	10,7
13,0	-	13,6	15,1	15,5	14,7	14,5	13,6	12,6	11,7	10,5	9,3
14,0	-	11,5	12,9	13,7	13,3	12,9	12,1	11,2	10,3	9,3	8,1
15,0	-	9,8	11,2	12,0	11,9	11,5	10,8	10,0	9,2	8,2	7,1
16,0	-	-	9,7	10,5	10,7	10,3	9,7	8,9	8,2	7,2	6,2
18,0	-	-	7,5	8,2	8,5	8,4	7,8	7,2	6,5	5,6	4,7
20,0	-	-	5,7	6,5	6,7	6,8	6,4	5,8	5,2	4,4	3,5
22,0	-	-	-	5,1	5,4	5,5	5,2	4,6	4,1	3,3	2,5
24,0	-	-	-	4,1	4,3	4,4	4,2	3,7	3,2	2,4	1,7
26,0	-	-	-	-	3,4	3,5	3,3	2,9	2,4	1,7	0,9
28,0	-	-	-	-	2,7	2,8	2,6	2,2	1,7	1,1	-
30,0	-	-	-	-	2,1	2,1	1,9	1,6	1,1	-	-
32,0	-	-	-	-	-	1,6	1,4	1,1	-	-	-
34,0	-	-	-	-	-	1,1	1,0	-	-	-	-



Load charts • Traglasten • Capacités de levage Capacidades • Capacità • Таблицы грузоподъемности

Working range • Arbeitsbereiche • Diagramme de levage • Gama de trabajo • Area di lavoro • Грузовысотные характеристики



64,0 m



0°-40°
11,0-18,0-26,0-34,0 m



7,8 m



360°

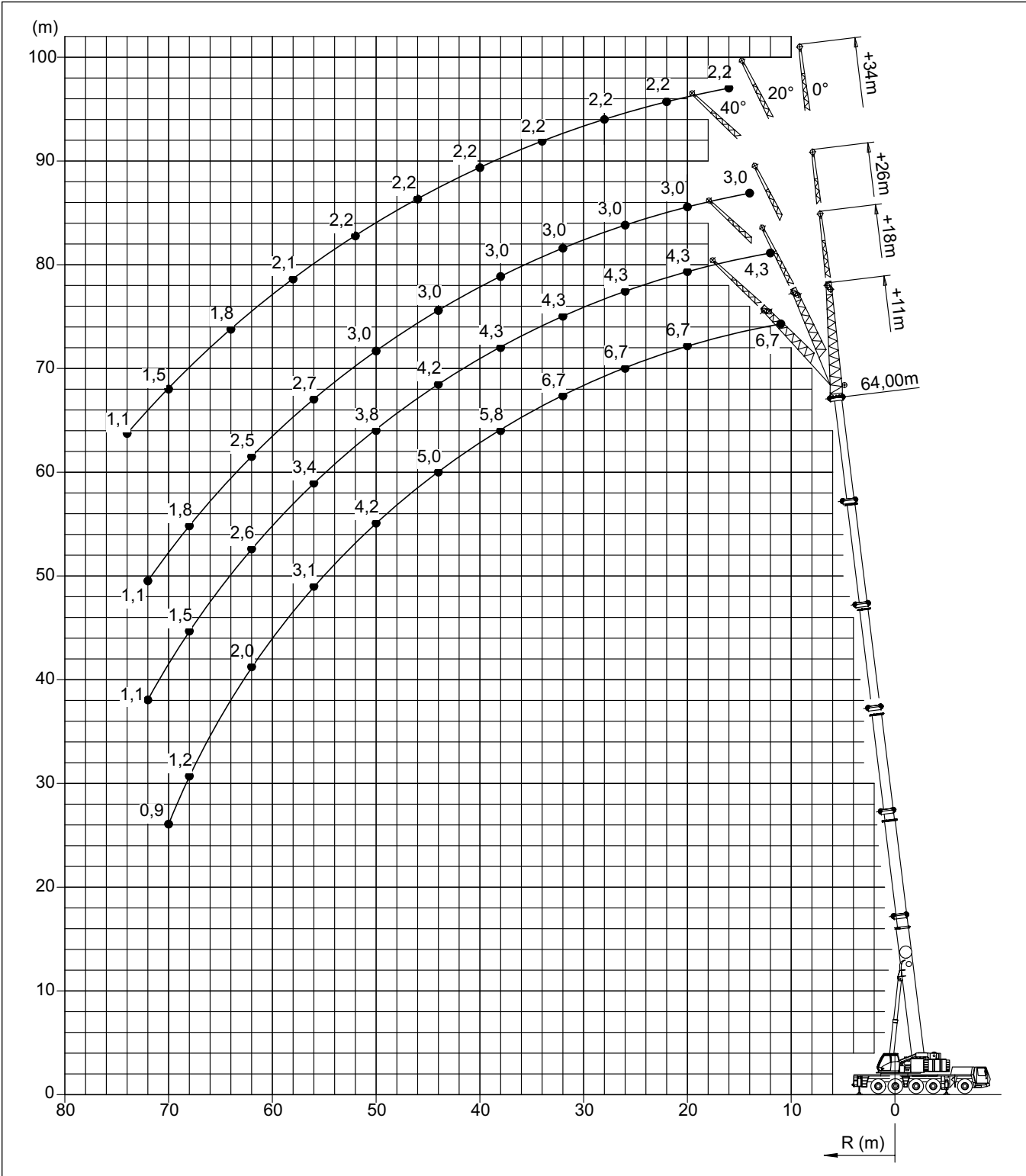

**Load charts • Traglasten • Capacités de levage
Capacidades • Capacità • Таблицы грузоподъемности**

**Jib configurations • Kombination der Auslegerverlängerung • Combinaisons de l'extension treillis
Configuración con extensiones de pluma • Combinazioni delle prolunghe del falcone • Конфигурации стрелы**

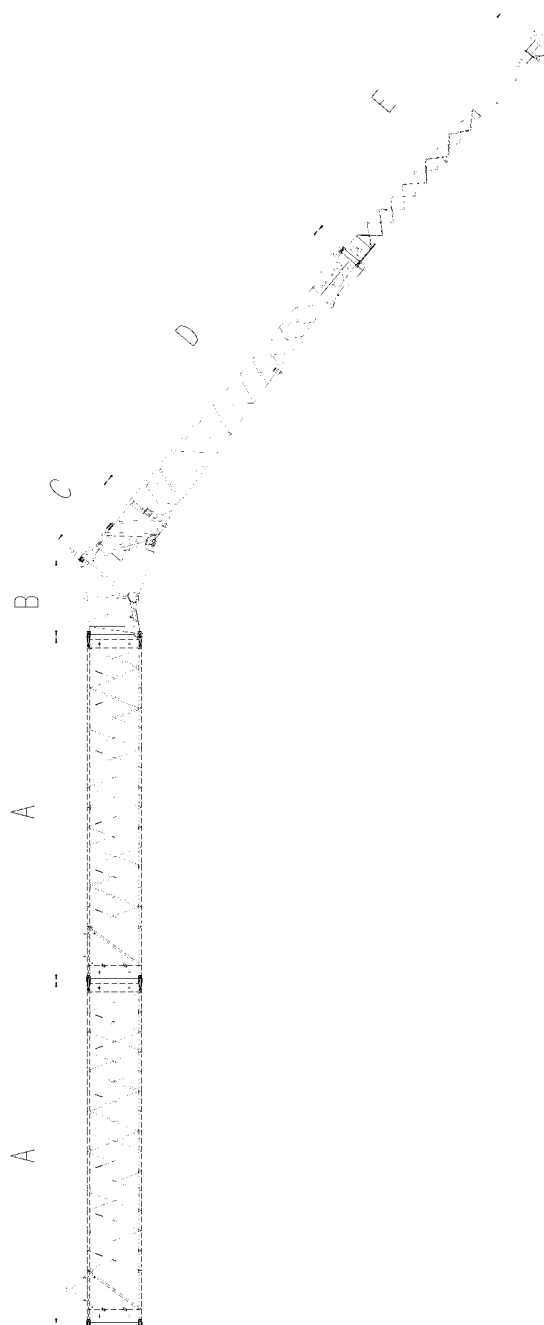

Total Length Gesamtlänge Longueur totale Longitud total Lunghezza Totale Общая длина	Intermediate section boom extension make-up Reihenfolge des Spitzenaufbaus Ordre des combinaisons de l'extension treillis Combinaciones de tramos intermedios de extensión de pluma Sequenza di combinazioni per le sezioni di traliccio del falcone Сборка промежуточной секции гуська крана				
	A 8,0 m	B 1,8 m	C 1,7 m	D 7,7 m	E 7,0 m
[m]					
3,5	-	1x	1x	-	-
11,0	-	1x	1x	1x	-
18,0	-	1x	1x	1x	1x
26,0	1x	1x	1x	1x	1x
34,0	2x	1x	1x	1x	1x

Load charts • Traglasten • Capacités de levage Capacidades • Capacità • Таблицы грузоподъемности

Swingaway (hydraulic luffing) • Klappspitze (hydraulisch wippbar) • Extension treillis (déport hydraulique) • Plumín (angulable hidráulicamente) • Falcone (brandeggio idraulico) • Складной удлинитель стрелы (гидравлическое изменение вылета)



59,0 - 64,0 m



11,0 m



7,8 m



360°



53,1 t



EN 13000

m m	59,0 11,0			64,0 11,0		
	0°	* 0° - 20°	* 20° - 40°	0°	* 0° - 20°	* 20° - 40°
10,0	7,7	-	-	-	-	-
11,0	7,7	-	-	6,7	-	-
12,0	7,7	-	-	6,7	-	-
13,0	7,7	7,7	-	6,7	-	-
14,0	7,7	7,7	-	6,7	6,7	-
15,0	7,7	7,7	7,4	6,7	6,7	-
16,0	7,7	7,7	7,4	6,7	6,7	6,6
18,0	7,7	7,7	7,4	6,7	6,7	6,6
20,0	7,7	7,7	7,4	6,7	6,7	6,6
22,0	7,7	7,7	7,3	6,7	6,7	6,6
24,0	7,7	7,7	7,3	6,7	6,7	6,6
26,0	7,7	7,7	7,3	6,7	6,7	6,6
28,0	7,7	7,7	7,2	6,7	6,7	6,6
30,0	7,7	7,7	7,1	6,7	6,7	6,6
32,0	7,4	7,4	7,0	6,7	6,4	6,4
34,0	6,9	7,0	6,9	6,4	6,2	6,1
36,0	6,5	6,5	6,6	6,1	5,9	5,9
38,0	6,1	6,2	6,3	5,8	5,7	5,6
40,0	5,7	5,8	5,9	5,4	5,4	5,4
42,0	5,4	5,4	5,6	5,1	5,2	5,2
44,0	5,0	5,1	5,2	4,8	4,9	5,0
46,0	4,7	4,8	4,9	4,5	4,6	4,7
48,0	4,4	4,5	4,6	4,2	4,3	4,5
50,0	4,0	4,0	4,2	4,0	4,1	4,2
52,0	3,5	3,5	3,7	3,7	3,8	4,0
54,0	3,2	3,3	-	3,3	3,3	3,5
56,0	3,0	3,1	-	3,0	3,0	3,1
58,0	2,8	2,9	-	2,6	2,6	-
60,0	2,6	2,7	-	2,3	2,3	-
62,0	2,5	2,5	-	2,0	2,0	-
64,0	2,2	-	-	1,7	1,7	-
66,0	-	-	-	1,4	1,4	-
68,0	-	-	-	1,2	1,2	-
70,0	-	-	-	0,9	-	-

*Luffing under load • Unter Teillast wippbar • Inclinaison sous charge • Angulación con carga • Brandeggio sotto carico • Изменение вылета под нагрузкой

Load charts • Traglasten • Capacités de levage Capacidades • Capacità • Таблицы грузоподъемности

Swingaway (hydraulic luffing) • Klappspitze (hydraulisch wippbar) • Extension treillis (déport hydraulique) • Plumín (angulable hidráulicamente) • Falcone (brandeggio idraulico) • Складной удлинитель стрелы (гидравлическое изменение вылета)



59,0 - 64,0 m



18,0 m



7,8 m



360°



53,1 t



EN 13000

m m	59,0 18,0			64,0 18,0		
	0°	* 0° - 20°	* 20° - 40°	0°	* 0° - 20°	* 20° - 40°
11,0	5,0	-	-	-	-	-
12,0	5,0	-	-	4,3	-	-
13,0	5,0	-	-	4,3	-	-
14,0	5,0	-	-	4,3	-	-
15,0	5,0	-	-	4,3	-	-
16,0	4,9	4,6	-	4,3	4,3	-
18,0	4,9	4,6	-	4,3	4,3	-
20,0	4,9	4,5	4,3	4,3	4,3	-
22,0	4,8	4,5	4,3	4,3	4,2	4,1
24,0	4,8	4,5	4,2	4,3	4,2	4,1
26,0	4,7	4,4	4,2	4,3	4,2	4,1
28,0	4,7	4,4	4,1	4,3	4,2	4,0
30,0	4,7	4,4	4,1	4,3	4,2	4,0
32,0	4,6	4,3	4,0	4,3	4,1	4,0
34,0	4,6	4,3	4,0	4,3	4,1	4,0
36,0	4,5	4,3	4,0	4,3	4,1	3,9
38,0	4,5	4,2	3,9	4,3	4,1	3,9
40,0	4,5	4,2	3,9	4,2	4,0	3,9
42,0	4,4	4,1	3,8	4,2	4,0	3,8
44,0	4,4	4,0	3,8	4,2	4,0	3,8
46,0	4,3	3,9	3,7	4,1	3,9	3,8
48,0	4,2	3,8	3,7	4,0	3,8	3,7
50,0	4,0	3,7	3,7	3,8	3,8	3,7
52,0	3,8	3,6	3,6	3,6	3,6	3,7
54,0	3,5	3,5	3,6	3,4	3,5	3,6
56,0	3,1	3,1	3,5	3,2	3,3	3,4
58,0	2,8	2,9	3,1	3,0	3,0	3,3
60,0	2,6	2,7	2,8	2,6	2,6	3,0
62,0	2,4	2,6	-	2,3	2,3	2,6
64,0	2,3	2,4	-	2,0	2,0	-
66,0	2,1	2,2	-	1,8	1,8	-
68,0	2,0	2,0	-	1,5	1,5	-
70,0	1,8	1,8	-	1,3	1,3	-
72,0	1,5	-	-	1,1	1,1	-

*Luffing under load • Unter Teillast wippbar • Inclinaison sous charge • Angulación con carga • Brandeggio sotto carico • Изменение вылета под нагрузкой



Load charts • Traglasten • Capacités de levage Capacidades • Capacità • Таблицы грузоподъемности

Boom extension (hydraulic luffing) • Auslegerverlängerung (hydraulisch wippbar) • Extension treillis (déport hydraulique)
Extension de pluma (angulable hidráulicamente) • Jib (brandeggio idraulico)
удлинитель стрелы (гидравлическое изменение вылета)



59,0 - 64,0 m



26,0 m



7,8 m



360°



53,1 t



EN 13000

m m	59,0 26,0			64,0 26,0		
	0°	* 0° - 20°	* 20° - 40°	0°	* 0° - 20°	* 20° - 40°
13,0	3,8	-	-	-	-	-
14,0	3,8	-	-	3,0	-	-
15,0	3,8	-	-	3,0	-	-
16,0	3,8	-	-	3,0	-	-
18,0	3,8	-	-	3,0	-	-
20,0	3,8	3,8	-	3,0	3,0	-
22,0	3,8	3,8	-	3,0	3,0	-
24,0	3,8	3,8	3,1	3,0	3,0	2,7
26,0	3,8	3,8	3,1	3,0	3,0	2,7
28,0	3,8	3,8	3,1	3,0	3,0	2,7
30,0	3,8	3,8	3,1	3,0	3,0	2,7
32,0	3,8	3,8	3,1	3,0	3,0	2,7
34,0	3,8	3,8	3,1	3,0	3,0	2,7
36,0	3,8	3,8	3,1	3,0	3,0	2,7
38,0	3,8	3,8	3,1	3,0	3,0	2,7
40,0	3,8	3,8	3,1	3,0	3,0	2,7
42,0	3,8	3,8	3,1	3,0	3,0	2,7
44,0	3,8	3,8	3,1	3,0	3,0	2,7
46,0	3,8	3,8	3,1	3,0	3,0	2,7
48,0	3,8	3,7	3,1	3,0	3,0	2,7
50,0	3,6	3,5	3,1	3,0	3,0	2,7
52,0	3,4	3,4	3,1	3,0	2,9	2,7
54,0	3,2	3,3	3,1	2,8	2,8	2,7
56,0	3,0	3,2	3,1	2,7	2,7	2,7
58,0	2,8	2,9	3,1	2,6	2,6	2,7
60,0	2,5	2,5	2,9	2,5	2,5	2,6
62,0	2,2	2,3	2,5	2,3	2,3	2,5
64,0	2,0	2,1	2,2	2,1	2,1	2,4
66,0	1,9	2,0	-	1,8	1,8	2,1
68,0	1,7	1,9	-	1,5	1,5	1,8
70,0	1,6	1,7	-	1,3	1,3	-
72,0	1,5	1,5	-	1,1	1,1	-
74,0	1,3	1,3	-	-	-	-
76,0	1,1	1,1	-	-	-	-
78,0	1,0	1,0	-	-	-	-

*Luffing under load • Unter Teillast wippbar • Inclinaison sous charge • Angulación con carga • Brandeggio sotto carico • Изменение вылета под нагрузкой

Load charts • Traglasten • Capacités de levage Capacidades • Capacità • Таблицы грузоподъемности

Boom extension (hydraulic luffing) • Auslegerverlängerung (hydraulisch wippbar) • Extension treillis (déport hydraulique)
Extensión de pluma (angulable hidráulicamente) • Jib (brandeggio idraulico)
удлинитель стрелы (гидравлическое изменение вылета)



59,0 - 64,0 m



34,0 m



7,8 m



360°



53,1 t



EN 13000





m m	59,0 34,0			64,0 34,0		
	0°	* 0° - 20°	* 20° - 40°	0°	* 0° - 20°	* 20° - 40°
15,0	2,8	-	-	-	-	-
16,0	2,8	-	-	2,2	-	-
18,0	2,8	-	-	2,2	-	-
20,0	2,8	-	-	2,2	-	-
22,0	2,8	2,8	-	2,2	2,2	-
24,0	2,8	2,8	-	2,2	2,2	-
26,0	2,8	2,8	1,8	2,2	2,2	1,5
28,0	2,8	2,8	1,8	2,2	2,2	1,5
30,0	2,8	2,8	1,8	2,2	2,2	1,5
32,0	2,8	2,8	1,8	2,2	2,2	1,5
34,0	2,8	2,8	1,8	2,2	2,2	1,5
36,0	2,8	2,8	1,8	2,2	2,2	1,5
38,0	2,8	2,7	1,8	2,2	2,2	1,5
40,0	2,7	2,7	1,8	2,2	2,2	1,5
42,0	2,7	2,7	1,8	2,2	2,2	1,5
44,0	2,7	2,7	1,8	2,2	2,2	1,5
46,0	2,7	2,7	1,8	2,2	2,2	1,5
48,0	2,7	2,7	1,8	2,2	2,2	1,5
50,0	2,7	2,7	1,8	2,2	2,2	1,5
52,0	2,6	2,7	1,8	2,2	2,2	1,5
54,0	2,6	2,6	1,8	2,2	2,2	1,5
56,0	2,6	2,5	1,8	2,1	2,2	1,5
58,0	2,5	2,4	1,8	2,0	2,1	1,5
60,0	2,3	2,3	1,8	1,9	2,0	1,5
62,0	2,2	2,2	1,8	1,9	1,9	1,5
64,0	1,9	1,9	1,8	1,8	1,8	1,5
66,0	1,7	1,7	1,8	1,7	1,7	1,5
68,0	1,5	1,5	1,7	1,5	1,5	1,5
70,0	1,3	1,5	1,5	1,3	1,3	1,5
72,0	1,2	1,3	-	1,0	1,0	1,3
74,0	1,1	1,2	-	-	-	1,1
76,0	1,0	1,1	-	-	-	-
78,0	0,9	0,9	-	-	-	-



*Luffing under load • Unter Teillast wippbar • Inclinaison sous charge • Angulación con carga • Brandeggio sotto carico • Изменение вылета под нагрузкой



Load charts • Traglasten • Capacités de levage Capacidades • Capacità • Таблицы грузоподъемности

Swingaway (hydraulic luffing) • Klappspitze (hydraulisch wippbar) • Extension treillis (déport hydraulique) • Plumín (angulable hidráulicamente) • Falcone (brandeggio idraulico) • Складной удлинитель стрелы (гидравлическое изменение вылета)

 59,0 - 64,0 m
  11,0 m
  7,8 m
  360°
  18,1 t



EN 13000

m m	59,0 11,0			64,0 11,0		
	0°	* 0° - 20°	* 20° - 40°	0°	* 0° - 20°	* 20° - 40°
10,0	7,7	-	-	-	-	-
11,0	7,7	-	-	6,7	-	-
12,0	7,7	-	-	6,7	-	-
13,0	7,7	7,7	-	6,7	-	-
14,0	7,7	7,7	-	6,7	6,7	-
15,0	7,7	7,7	7,4	6,7	6,7	-
16,0	7,7	7,7	7,4	6,7	6,7	6,6
18,0	7,7	7,7	7,4	6,7	6,7	6,6
20,0	7,7	7,7	7,4	6,7	6,7	6,6
22,0	7,6	7,6	7,3	6,7	6,7	6,6
24,0	7,2	7,2	7,1	6,4	6,4	6,6
26,0	6,2	6,2	6,9	5,4	5,4	6,1
28,0	5,3	5,3	5,9	4,5	4,5	5,1
30,0	4,5	4,5	5,0	3,7	3,7	4,3
32,0	3,7	3,7	4,3	3,0	3,0	3,5
34,0	3,1	3,1	3,6	2,4	2,4	2,9
36,0	2,6	2,6	3,0	1,8	1,8	2,3
38,0	2,1	2,1	2,5	1,4	1,4	1,8
40,0	1,6	1,6	2,0	0,9	0,9	1,3
42,0	1,2	1,2	1,5	-	-	0,9
44,0	-	-	1,1	-	-	-

*Luffing under load • Unter Teillast wippbar • Inclinaison sous charge • Angulación con carga • Brandeggio sotto carico • Изменение вылета под нагрузкой

 59,0 - 64,0 m
  18,0 m
  7,8 m
  360°
  18,1 t



EN 13000

m m	59,0 18,0			64,0 18,0		
	0°	* 0° - 20°	* 20° - 40°	0°	* 0° - 20°	* 20° - 40°
11,0	5,0	-	-	4,3	-	-
12,0	5,0	-	-	4,3	-	-
13,0	5,0	-	-	4,3	-	-
14,0	5,0	-	-	4,3	-	-
15,0	5,0	-	-	4,3	-	-
16,0	4,9	4,6	-	4,3	4,3	-
18,0	4,9	4,6	-	4,3	4,3	-
20,0	4,9	4,5	4,3	4,3	4,3	-
22,0	4,8	4,5	4,3	4,3	4,2	4,1
24,0	4,8	4,5	4,2	4,3	4,2	4,1
26,0	4,7	4,4	4,2	4,3	4,2	4,1
28,0	4,6	4,4	4,1	4,3	4,2	4,0
30,0	4,5	4,3	4,1	4,0	4,0	4,0
32,0	4,0	4,0	4,0	3,3	3,3	4,0
34,0	3,4	3,4	4,0	2,7	2,7	3,6
36,0	2,9	2,9	3,6	2,2	2,2	3,0
38,0	2,4	2,4	3,1	1,7	1,7	2,5
40,0	1,9	1,9	2,6	1,2	1,2	2,0
42,0	1,5	1,5	2,1	0,9	0,9	1,5
44,0	1,2	1,2	1,7	-	-	1,1
46,0	-	-	1,4	-	-	-
48,0	-	-	1,0	-	-	-

*Luffing under load • Unter Teillast wippbar • Inclinaison sous charge • Angulación con carga • Brandeggio sotto carico • Изменение вылета под нагрузкой

Load charts • Traglasten • Capacités de levage Capacidades • Capacità • Таблицы грузоподъемности

**Boom extension (hydraulic luffing) • Auslegerverlängerung (hydraulisch wippbar) • Extension treillis (déport hydraulique)
Extensión de pluma (angulable hidráulicamente) • Jib (brandeggio idraulico)
удлинитель стрелы (гидравлическое изменение вылета)**



59,0 - 64,0 m



26,0 m



7,8 m



360°



18,1 t



EN 13000

m m	59,0 26,0			64,0 26,0		
	0°	* 0° - 20°	* 20° - 40°	0°	* 0° - 20°	* 20° - 40°
13,0	3,8	-	-	-	-	-
14,0	3,8	-	-	3,0	-	-
15,0	3,8	-	-	3,0	-	-
16,0	3,8	-	-	3,0	-	-
18,0	3,8	-	-	3,0	-	-
20,0	3,8	3,8	-	3,0	3,0	-
22,0	3,8	3,8	-	3,0	3,0	-
24,0	3,8	3,8	3,1	3,0	3,0	2,7
26,0	3,8	3,8	3,1	3,0	3,0	2,7
28,0	3,8	3,8	3,1	3,0	3,0	2,7
30,0	3,8	3,8	3,1	3,0	3,0	2,7
32,0	3,5	3,5	3,1	3,0	3,0	2,7
34,0	3,3	3,3	3,1	2,6	2,6	2,7
36,0	2,8	2,8	2,9	2,1	2,1	2,7
38,0	2,3	2,3	2,9	1,6	1,6	2,4
40,0	1,9	1,9	2,5	1,2	1,2	1,9
42,0	1,5	1,5	2,1	-	-	1,5
44,0	1,1	1,1	1,7	-	-	1,1
46,0	-	-	1,3	-	-	-
48,0	-	-	1,0	-	-	-

*Luffing under load • Unter Teillast wippbar • Inclinaison sous charge • Angulación con carga • Brandeggio sotto carico • Изменение вылета под нагрузкой



59,0 - 64,0 m



34,0 m



7,8 m



360°



18,1 t







EN 13000



m m	59,0 34,0			64,0 34,0		
	0°	* 0° - 20°	* 20° - 40°	0°	* 0° - 20°	* 20° - 40°
15,0	2,8	-	-	-	-	-
16,0	2,8	-	-	2,2	-	-
18,0	2,8	-	-	2,2	-	-
20,0	2,8	-	-	2,2	-	-
22,0	2,8	2,8	-	2,2	2,2	-
24,0	2,8	2,8	-	2,2	2,2	-
26,0	2,8	2,8	1,8	2,2	2,2	1,5
28,0	2,8	2,8	1,8	2,2	2,2	1,5
30,0	2,8	2,8	1,8	2,2	2,2	1,5
32,0	2,8	2,8	1,8	2,2	2,2	1,5
34,0	2,5	2,5	1,8	2,2	2,2	1,5
36,0	2,5	2,5	1,8	1,9	1,9	1,5
38,0	2,2	2,2	1,8	1,5	1,5	1,5
40,0	1,7	1,7	1,8	1,1	1,1	1,5
42,0	1,3	1,3	1,7	-	-	1,4
44,0	1,0	1,0	1,6	-	-	1,0
46,0	-	-	1,2	-	-	-
48,0	-	-	0,9	-	-	-

*Luffing under load • Unter Teillast wippbar • Inclinaison sous charge • Angulación con carga • Brandeggio sotto carico • Изменение вылета под нагрузкой

Load charts • Traglasten • Capacités de levage Capacidades • Capacità • Таблицы грузоподъемности



Swingaway (hydraulic luffing) • Klappspitze (hydraulisch wippbar) • Extension treillis (déport hydraulique) • Plumín (angulable hidráulicamente) • Falcone (brandeggio idraulico) • Складной удлинитель стрелы (гидравлическое изменение вылета)

 59,0 - 64,0 m
  11,0 m
  7,8 m
  360°
  13,1 t



EN 13000

m m	59,0 11,0			64,0 11,0		
	0°	* 0° - 20°	* 20° - 40°	0°	* 0° - 20°	* 20° - 40°
10,0	7,7	-	-	-	-	-
11,0	7,7	-	-	6,7	-	-
12,0	7,7	-	-	6,7	-	-
13,0	7,7	7,7	-	6,7	-	-
14,0	7,7	7,7	-	6,7	6,7	-
15,0	7,7	7,7	7,4	6,7	6,7	-
16,0	7,7	7,7	7,4	6,7	6,7	6,6
18,0	7,7	7,7	7,4	6,7	6,7	6,6
20,0	7,6	7,6	7,4	6,7	6,7	6,6
22,0	6,8	6,8	7,1	5,9	5,9	6,6
24,0	5,7	5,7	6,4	4,8	4,8	5,6
26,0	4,7	4,7	5,4	3,9	3,9	4,6
28,0	3,9	3,9	4,5	3,1	3,1	3,8
30,0	3,2	3,2	3,7	2,4	2,4	3,0
32,0	2,6	2,6	3,1	1,8	1,8	2,4
34,0	2,0	2,0	2,5	1,3	1,3	1,8
36,0	1,5	1,5	1,9	-	-	1,3
38,0	1,1	1,1	1,4	-	-	-
40,0	-	-	1,0	-	-	-

*Luffing under load • Unter Teillast wippbar • Inclinaison sous charge • Angulación con carga • Brandeggio sotto carico • Изменение вылета под нагрузкой

 59,0 - 64,0 m
  18,0 m
  7,8 m
  360°
  13,1 t



EN 13000

m m	59,0 18,0			64,0 18,0		
	0°	* 0° - 20°	* 20° - 40°	0°	* 0° - 20°	* 20° - 40°
11,0	5,0	-	-	-	-	-
12,0	5,0	-	-	4,3	-	-
13,0	5,0	-	-	4,3	-	-
14,0	5,0	-	-	4,3	-	-
15,0	5,0	-	-	4,3	-	-
16,0	4,9	4,6	-	4,3	4,3	-
18,0	4,9	4,6	-	4,3	4,3	-
20,0	4,9	4,5	4,3	4,3	4,3	-
22,0	4,8	4,5	4,3	4,3	4,2	4,1
24,0	4,8	4,5	4,2	4,3	4,2	4,1
26,0	4,6	4,3	4,2	4,2	4,2	4,1
28,0	4,2	4,2	4,1	3,4	3,4	4,0
30,0	3,5	3,5	4,1	2,7	2,7	3,8
32,0	2,9	2,9	3,8	2,1	2,1	3,1
34,0	2,3	2,3	3,1	1,6	1,6	2,5
36,0	1,8	1,8	2,6	1,1	1,1	2,0
38,0	1,4	1,4	2,1	-	-	1,5
40,0	1,0	1,0	1,6	-	-	1,0
42,0	-	-	1,2	-	-	-
44,0	-	-	0,9	-	-	-

*Luffing under load • Unter Teillast wippbar • Inclinaison sous charge • Angulación con carga • Brandeggio sotto carico • Изменение вылета под нагрузкой

Load charts • Traglasten • Capacités de levage Capacidades • Capacità • Таблицы грузоподъемности

**Boom extension (hydraulic luffing) • Auslegerverlängerung (hydraulisch wippbar) • Extension treillis (déport hydraulique)
Extensión de pluma (angulable hidráulicamente) • Jib (brandeggio idraulico)
удлинитель стрелы (гидравлическое изменение вылета)**



59,0 - 64,0 m



26,0 m



7,8 m



360°



13,1 t



EN 13000

m m	59,0 26,0			64,0 26,0		
	0°	* 0° - 20°	* 20° - 40°	0°	* 0° - 20°	* 20° - 40°
13,0	3,8	-	-	-	-	-
14,0	3,8	-	-	3,0	-	-
15,0	3,8	-	-	3,0	-	-
16,0	3,8	-	-	3,0	-	-
18,0	3,8	-	-	3,0	-	-
20,0	3,8	3,8	-	3,0	3,0	-
22,0	3,8	3,8	-	3,0	3,0	-
24,0	3,8	3,8	3,1	3,0	3,0	2,7
26,0	3,8	3,8	3,1	3,0	3,0	2,7
28,0	3,5	3,5	3,1	3,0	3,0	2,7
30,0	3,4	3,4	3,1	2,6	2,6	2,7
32,0	2,8	2,8	3,0	2,0	2,0	2,7
34,0	2,2	2,2	2,9	1,5	1,5	2,4
36,0	1,7	1,7	2,5	1,1	1,1	1,9
38,0	1,3	1,3	2,0	-	-	1,4
40,0	0,9	0,9	1,6	-	-	1,0
42,0	-	-	1,2	-	-	-

*Luffing under load • Unter Teillast wippbar • Inclinaison sous charge • Angulación con carga • Brandeggio sotto carico • Изменение вылета под нагрузкой



59,0 - 64,0 m



34,0 m



7,8 m



360°



13,1 t



EN 13000

m m	59,0 34,0			64,0 34,0		
	0°	* 0° - 20°	* 20° - 40°	0°	* 0° - 20°	* 20° - 40°
15,0	2,8	-	-	-	-	-
16,0	2,8	-	-	2,2	-	-
18,0	2,8	-	-	2,2	-	-
20,0	2,8	2,8	-	2,2	-	-
22,0	2,8	2,8	-	2,2	2,2	-
24,0	2,8	2,8	1,8	2,2	2,2	-
26,0	2,8	2,8	1,8	2,2	2,2	1,5
28,0	2,8	2,8	1,8	2,2	2,2	1,5
30,0	2,5	2,5	1,8	2,2	2,2	1,5
32,0	2,5	2,5	1,8	1,9	1,9	1,5
34,0	2,1	2,1	1,8	1,4	1,4	1,5
36,0	1,6	1,6	1,8	0,9	0,9	1,5
38,0	1,2	1,2	1,7	-	-	1,3
40,0	-	-	1,5	-	-	0,9
42,0	-	-	1,1	-	-	-

*Luffing under load • Unter Teillast wippbar • Inclinaison sous charge • Angulación con carga • Brandeggio sotto carico • Изменение вылета под нагрузкой



Load charts • Traglasten • Capacités de levage Capacidades • Capacità • Таблицы грузоподъемности

**Integrated heavy duty jib • Integrierte Schwerlastspitze • Flèche intégrée haute résistance
Pluma integrada de alta resistencia • Braccio integrato ad alta resistenza
Интегрированная стрела для тяжелых условий эксплуатации**



59,0 - 64,0 m



7,5 m



360°



3,6 m

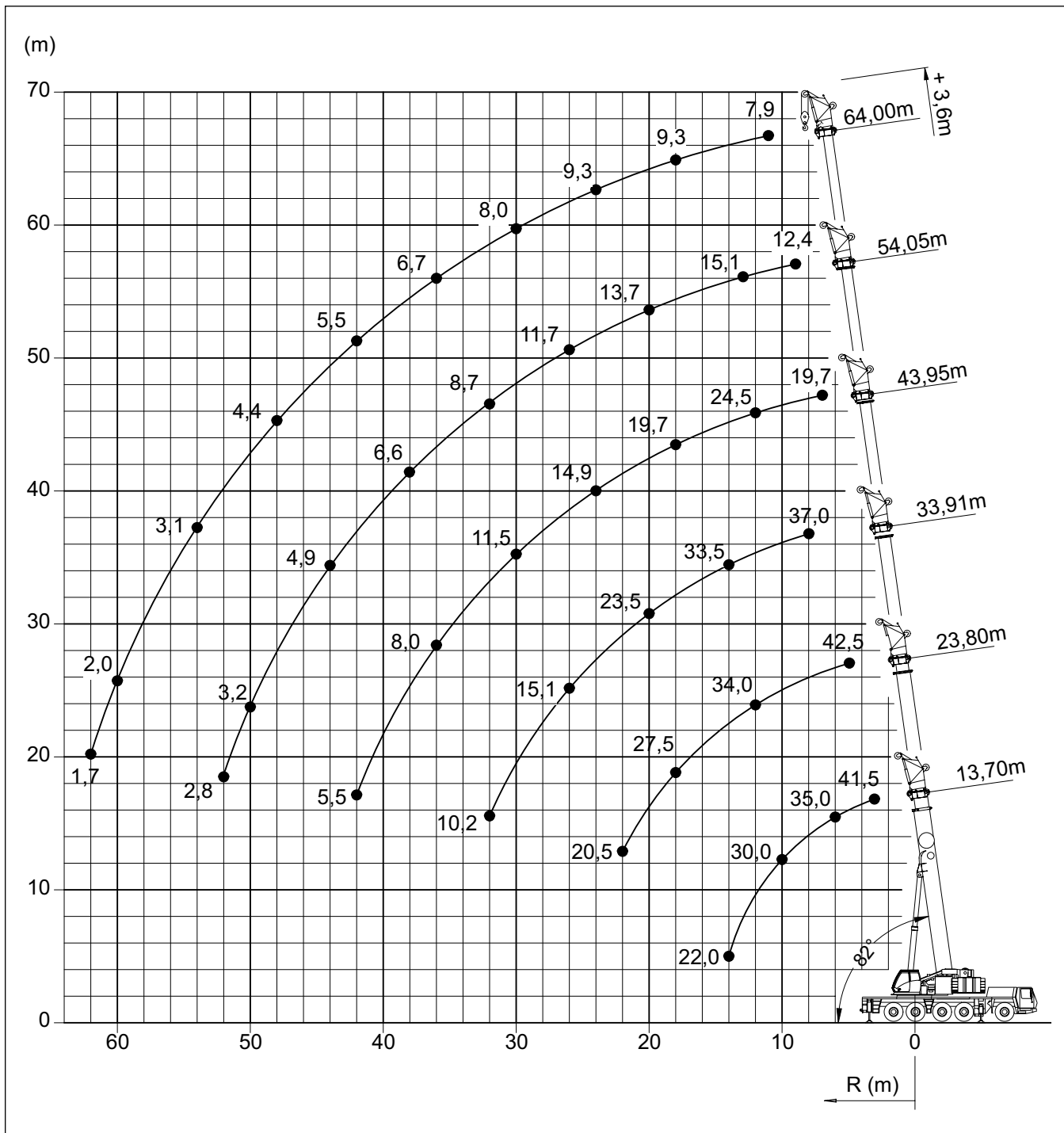

Load charts • Traglasten • Capacités de levage Capacidades • Capacità • Таблицы грузоподъемности

Integrated heavy duty jib • Integrierte Schwerlastspitze • Flèche intégrée haute résistance
Pluma integrada de alta resistencia • Braccio integrato ad alta resistenza
Интегрированная стрела для тяжелых условий эксплуатации



59,0 - 64,0 m



3,6 m



7,8 m



360°



53,1 t



EN 13000

m m	59,0 3,6			64,0 3,6		
	0°	* 0° - 20°	* 20° - 40°	0°	* 0° - 20°	* 20° - 40°
11,0	-	-	10,0	-	-	7,9
12,0	-	-	10,0	-	-	7,9
13,0	-	-	10,0	-	-	7,9
14,0	11,7	10,0	10,0	-	-	7,9
15,0	11,7	10,0	10,0	-	-	7,9
16,0	11,7	10,0	10,0	9,3	8,2	7,9
18,0	11,7	10,0	10,0	9,3	8,2	7,9
20,0	11,7	10,0	10,0	9,3	8,2	7,9
22,0	11,3	10,0	10,0	9,3	8,2	7,9
24,0	10,8	10,0	10,0	9,3	8,2	7,9
26,0	10,2	10,0	10,0	9,3	8,2	7,9
28,0	9,4	9,7	10,0	8,8	8,2	7,9
30,0	8,5	8,6	8,7	8,0	8,0	7,9
32,0	8,0	8,0	8,1	7,5	7,5	7,7
34,0	7,4	7,4	7,5	7,0	7,0	7,2
36,0	6,9	6,9	7,0	6,6	6,6	6,7
38,0	6,4	6,3	6,4	6,2	6,2	6,3
40,0	5,9	5,9	5,9	5,8	5,8	5,9
42,0	5,5	5,5	5,5	5,4	5,4	5,5
44,0	5,0	5,0	5,1	5,0	5,1	5,1
46,0	4,6	4,6	-	4,7	4,7	4,7
48,0	4,1	4,1	-	4,4	4,4	4,4
50,0	3,8	3,8	-	4,0	4,0	-
52,0	3,6	3,6	-	3,5	3,5	-
54,0	3,4	3,4	-	3,1	3,1	-
56,0	3,1	3,2	-	2,7	2,7	-
58,0	-	-	-	2,3	2,3	-
60,0	-	-	-	2,0	2,0	-
62,0	-	-	-	1,7	-	-

*Luffing under load • Unter Teillast wippbar • Inclinaison sous charge • Angulación con carga • Brandeggio sotto carico • Изменение вылета под нагрузкой



59,0 - 64,0 m



3,6 m



7,8 m



360°



18,1 t



EN 13000

m m	59,0 3,6			64,0 3,6		
	0°	* 0° - 20°	* 20° - 40°	0°	* 0° - 20°	* 20° - 40°
11,0	-	-	10,0	-	-	7,9
12,0	-	-	10,0	-	-	7,9
13,0	-	-	10,0	-	-	7,9
14,0	11,7	10,0	10,0	-	-	7,9
15,0	11,7	10,0	10,0	-	-	7,9
16,0	11,7	10,0	10,0	9,3	8,2	7,9
18,0	11,0	10,0	10,0	9,3	8,2	7,9
20,0	10,0	8,8	9,0	9,1	8,2	7,9
22,0	8,4	8,1	8,1	7,7	7,7	7,8
24,0	7,1	7,2	7,3	6,4	6,4	6,5
26,0	6,0	6,1	6,2	5,3	5,3	5,4
28,0	5,1	5,2	5,3	4,4	4,4	4,5
30,0	4,2	4,4	4,4	3,6	3,6	3,7
32,0	3,5	3,6	3,7	2,9	2,9	2,9
34,0	2,9	3,0	3,0	2,3	2,3	2,3
36,0	2,3	2,4	2,4	1,7	1,7	1,7
38,0	1,8	1,9	1,9	1,2	1,2	1,2
40,0	1,3	1,4	1,5	-	-	-
42,0	0,9	1,0	1,0	-	-	-

*Luffing under load • Unter Teillast wippbar • Inclinaison sous charge • Angulación con carga • Brandeggio sotto carico • Изменение вылета под нагрузкой



Load charts • Traglasten • Capacités de levage Capacidades • Capacità • Таблицы грузоподъемности

Integrated heavy duty jib • Integrierte Schwerlastspitze • Flèche intégrée haute résistance
Pluma integrada de alta resistencia • Braccio integrato ad alta resistenza
Интегрированная стрела для тяжелых условий эксплуатации

 59,0 - 64,0 m
  3,6 m
  7,8 m
  360°
  13,1 t

  EN 13000

m m	59,0 3,6			64,0 3,6		
	0°	* 0° - 20°	* 20° - 40°	0°	* 0° - 20°	* 20° - 40°
11,0	-	-	10,0	-	-	7,9
12,0	-	-	10,0	-	-	7,9
13,0	-	-	10,0	-	-	7,9
14,0	11,7	10,0	10,0	-	-	7,9
15,0	11,7	10,0	10,0	-	-	7,9
16,0	11,0	10,0	10,0	9,3	8,2	7,9
18,0	9,8	8,6	8,8	8,9	8,2	7,9
20,0	8,1	8,1	8,1	7,3	7,3	7,4
22,0	6,7	6,8	6,9	5,9	5,9	6,1
24,0	5,5	5,7	5,7	4,8	4,8	4,9
26,0	4,5	4,7	4,7	3,9	3,9	3,9
28,0	3,7	3,8	3,9	3,0	3,0	3,1
30,0	2,9	3,1	3,1	2,3	2,3	2,4
32,0	2,3	2,4	2,5	1,7	1,7	1,7
34,0	1,7	1,8	1,9	1,1	1,1	1,2
36,0	1,2	1,3	1,4	-	-	-
38,0	-	0,9	0,9	-	-	-

*Luffing under load • Unter Teillast wippbar • Inclinaison sous charge • Angulación con carga • Brandeggio sotto carico • Изменение вылета под нагрузкой

Notes • Hinweise • Notes • Notas • Note • Примечания

Symbols • Symbolerklärung • Glossaire des symboles • Glosario de simbolos • Glossario dei simboli • СИМВОЛЫ



Axles
Achsen
Ponts
Ejes
Assali
Оси



Crane functions
Kranbewegungen
Mouvements de la grue
Funciones de la grúa
Funzioni della gru
Функции крана



Hookblock / Capacity
Hakenflasche / Traglast
Moufle / Force de levage
Gancho / Capacidad
Gancio / Capacità
Крюковой блок / Грузоподъемность



Speed
Geschwindigkeit
Vitesse
Velocidad
Velocità
Скорость



Axle load
Achslast
Charge à l'essieu
Carga por eje
Carico sugli assi
Нагрузка на ось



Crane travel
Fahrstellung
Déplacement de la grue
Grúa en traslado
Traslazione gru
Перемещение крана



Hydraulic system
Hydrauliksystem
Circuit hydraulique
Sistema hidráulico
Impianto idraulico
Гидравлическая система



Suspension
Federung
Suspension
Suspensión
Sospensioni
Подвеска



Boom
Ausleger
Flèche
Pluma
Braccio
Стрела



Drive/Steer
Antrieb/Lenkung
Direction/Déplacement
Tracción/Dirección
Trazione/Sterzo
Ведущие/Управляемые оси



Lattice extension
Gitterspitze
Extension treillis
Extensión de celosia
Falcone tralicciato
Гусек



Transmission / Gear
Getriebe / Gang
Boîte de vitesses / Rapport
Transmisión / Cambio
Trasmissione / Cambio
Трансмиссия / передача



Boom elevation
Wippwerk
Relevage
Elevacion de pluma
Elevazione braccio
Подъем стрелы



Electrical system
Elektrische Anlage
Circuit électrique
Sistema eléctrico
Impianto elettrico
Электросистема



Lattice extension (luffing)
Gitterspitze (wippbar)
Extension treillis (volée variable)
Extensión de celosia (angularmente hidráulicamente)
Falcone tralicciato (inclinabile)
Гусек (с изменением вылета)



Travel speed
Fahrgeschwindigkeit
Vitesse de déplacement
Velocidad de desplazamiento
Velocità di traslazione
Скорость движения



Boom telescoping
Teleskopieren
Télescopage de flèche
Telescopaje de pluma
Lunghezza braccio
Выдвижение стрелы



Engine
Motor
Moteur
Motor
Motore
Двигатель



Luffing jib
Wippspitzenausleger
Volée variable
Plumín angularable
Falcone a volata variabile
Маневровый гусек



Tyres
Bereifung
Pneumatiques
Neumáticos
Pneumatici
Шины



Brakes
Bremsen
Freins
Frenos
Freni
Тормоза



Free on wheels
Freistehend
Sur pneus
Sobre neumáticos
Su gomme
Свободные внутренние колеса



Low range
Kriechgang
Gamme basse
Marchas cortas
Fuoristrada
Низкий диапазон



Cab
Kabine
Cabine
Cabina
Cabina
Кабина



Gradeability
Steigfähigkeit
Aptitude en pente
Superacion de pendientes
Pendenza superabile
Преодолеваемый уклон



Outriggers
Abstützung
Calage
Estabilizadores
Stabilizzatori
Выносные опоры



Carrier frame
Chassis-Rahmen
Châssis porteur
Bastidor
Telaio
Рама тягача



Main hoist
Haupthubwerk
Treuil principal
Cabrestante principal
Argano principale
Лебедка основного подъема



Radius
Ausladung
Portée
Radio
Raggio
Вылет



Counterweight
Gegengewicht
Contrepoids
Contrapeso
Contrappeso
Противовес



Auxiliary hoist
Hilfshubwerk
Treuil auxiliaire
Cabrestante auxiliar
Argano secondario
Лебедка вспомогательного подъема



Slewing/Working range
Drehwerk/Arbeitsbereich
Orientation/Rayon d'opération
Giro/Gama de trabajo
Rotazione/Area di lavoro
Поворот/ Рабочий диапазон

Grove Manitowoc National Crane Potain



Regional headquarters

Manitowoc - Americas

Manitowoc, Wisconsin, USA

Tel: +1 920 684 6621

Fax: +1 920 683 6278

Shady Grove, Pennsylvania, USA

Tel: +1 717 597 8121

Fax: +1 717 597 4062

Manitowoc - Europe, Middle East & Africa

Ecully, France

Tel: +33 (0)4 72 18 20 20

Fax: +33 (0)4 72 18 20 00

Manitowoc - Asia Pacific

Shanghai, China

Tel: +86 21 6457 0066

Fax: +86 21 6457 4955

Regional offices

Americas

Brazil

Alphaville

Mexico

Monterrey

Chile

Santiago

Europe, Middle East & Africa

Algeria

Hydra

Czech Republic

Netvorice

France

Baudemont

Cergy

Decines

Germany

Langenfeld

Hungary

Budapest

Italy

Parabiago

Netherlands

Breda

Poland

Warsaw

Portugal

Baltar

Lisbon

Russia

Moscow

U.A.E.

Dubai

U.K.

Buckingham

Asia - Pacific

Australia

Brisbane

Melbourne

Sydney

China

Beijing

Singapore

Xi'an

Korea

Seoul

India

Pune

Philippines

Makati City

Factories

Brazil

Alphaville

China

Zhangjiagang

France

Charlieu

La Clayette

Moulins

Germany

Wilhelmshaven

India

Calcutta

Pune

Italy

Niella Tanaro

Portugal

Baltar

Fânzeres

Slovakia

Saris

USA

Manitowoc

Port Washington

Shady Grove

This document is non-contractual. Constant improvement and engineering progress make it necessary that we reserve the right to make specification, equipment, and price changes without notice. Illustrations shown may include optional equipment and accessories and may not include all standard equipment.

Die Angaben in diesem Dokument erfolgen ohne Gewähr. Wir verbessern unsere Produkte ständig und integrieren den technischen Fortschritt. Aus diesem Grund behalten wir uns das Recht vor, die technischen Daten, die Ausstattungsdetails und die Preise unserer Maschinen ohne Vorankündigung zu ändern.

Ce document est non-contractuel. Du fait de sa politique d'amélioration constante de ses produits liée au progrès technique, la Société se réserve le droit de procéder sans préavis à des changements de spécifications, d'équipement ou de prix. Les illustrations peuvent comporter des équipements ou accessoires optionnels ou ne pas comporter des équipements standards.

Este documento no es contractual. El perfeccionamiento constante y el avance tecnológico hacen necesario que la empresa se reserve el derecho de efectuar cambios en las especificaciones, equipo y precios sin previo aviso. En las ilustraciones se puede incluir equipo y accesorios opcionales y es posible que no se muestre el equipo normal.

Documento non contrattuale. In considerazione della sua politica di costante miglioramento dei prodotti connesso al progresso tecnico, la Società si riserva il diritto di modificare senza preavviso specifiche, equipaggiamenti o prezzi. Le illustrazioni possono contenere equipaggiamenti o accessori optional o non contenere equipaggiamenti standard.

Данный документ не является контрактным. Принимая во внимание необходимость постоянного совершенствования и модернизации мы оставляем за собой право изменять спецификации, конструкции и стоимость без предварительного уведомления. Приведенные иллюстрации могут содержать дополнительные компоненты и принадлежности, не входящие в стандартный комплект поставки оборудования.

©2009 Manitowoc
Printed in France
Form N° GMK5170
Part N° 01-GMK5170-00-Apr2009

Bigge Crane and Rigging Co.

10700 Bigge Avenue
San Leandro, CA 94577
Phone: (888) 337-BIGGE or (510) 638-8100
Fax: (510) 639-4053
Email: info@bigge.com
Web site: www.bigge.com

www.manitowoc.com

