

models 30100C ■ 30124C ■

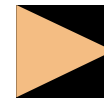

product guide

features

- 30 ton (27,3 mton) capacity
- 5-section 124' (37,8 m) proportional boom
- 4-section 100' (30,5 m) proportional boom
- 134' 8" (41 m) maximum main boom tip height
- 2-section, 30' 6" (9,3 m) to 55' (16,8 m) jib
- 165' 11" (50,6 m) maximum tip height
- 2-speed planetary hoist with 14,500 lb (6 591 kg) theoretical line pull on bottom layer
- Removable boom rest
- Load moment indicator—with digital display and overload shutdown
- 22' 1.25" (6,7 m) out-and-down outriggers at full extension
- Intermediate and fully extended outrigger charts are standard
- System pressure gauge
- Clamp-on mounting
- Rugged, weatherproof, automotive style electrical system
- Manitowoc CraneCARESM comprehensive support

contents

Specifications	2
Outline Dimensions	4
30100C Fully Extended Boom/Jib Range Diagram	6
30100C Fully Extended Boom/Jib Load Charts	7
30100C Intermediate Boom/Jib Range Diagram	8
30100C Intermediate Boom/Jib Load Charts	9
30124C Fully Extended Boom/Jib Range Diagram	10
30124C Fully Extended Boom/Jib Load Charts	11
30124C Intermediate Boom/Jib Range Diagram	12
30100C Intermediate Boom/Jib Load Charts	13
Load Chart Data	14
CraneCARE SM	15



specifications

Upperworks

2



Boom

Booms – Inverted T-cross section, 4- or 5-section telescoping type, extended and retracted proportionally by a double-acting hydraulic cylinder and cable-crowd system. **30100C** – 4-Section 30' 6" (9,3 m) to 100' 0" (30,5 m). Maximum main boom tip height 111' 4" (33,9 m). 2-section, 31' (9,5 m) to 55' (16,8 m) jib. Maximum tip height 166' 8" (50,8 m). **30124C** – 5-section 31' 5/8" (9,5 m) to 123' 8 5/8" (37,7 m). Maximum main boom tip height 134' 8" (41,1 m). 1-section, 31' (9,5 m) jib. Maximum tip height 165' 11" (50,6 m).

Quick Reeve Boom Point – Three high-density nylon sheaves mounted on heavy-duty roller bearings. Two removable pin-type rope guards.

Boom Elevation – Double-acting hydraulic cylinder. Working range from 10° below horizontal to 80° above.

Load Hook – 5-ton (4,5 mton) capacity hook with heavy-duty swivel and weight is provided for single-line operation.



Hoist

Hoist – Maximum theoretical line speed 380 fpm (115,8 mpm). Maximum theoretical bottom-layer line pull 14,500 lb (6 577 kg). Two-speed planetary reducer. Wet multi-disc internal brake is spring-applied, pressure-released.

Wire Rope – 335' (102,1 m) of 5/8" (16 mm) rotation resistant type.



Swing System

Externally mounted, double-reduction planetary driven by hydraulic motor. Maximum theoretical swing speed 1.5 rpm. Wet multi-disc internal brake is spring-applied, pressure-released. Oversized diameter ball-bearing swing circle with external gear. 372° non-continuous rotation.



Outriggers

Out-and-down style outriggers, operated independently for precise leveling. 22' 1 1/4" (6,8 m) spread at full extension and 13' 4" (4,1 m) spread at intermediate extension. 16" (406 mm) diameter floats. Bubble level located near outrigger controls.



Mounting

Mounting – Pedestal and subframe are mounted to chassis by threaded rods and clamp plates. No welding, drilling, or bolting to truck frame is required.

Underframe Out-and-Down Type Stabilizers – 8' (2,4 m) retracted; 18' 6" (5,6 m) extended. Operated independently for precise leveling. Double-acting hydraulic cylinders. Fixed pad size is 12" (305 mm) diameter.

Subframe – Torsionally resistant, rigid 4-plate design. Mounted under crane full length of truck frame.

Rear Underride Protection – Supplied on factory-mounted cranes. Fabricated structure mounted under rear of bed. Complies with Bureau Motor Carrier Safety Standard 393.86.

Boom Rest – Heavy-duty fabrication. Easily removed to simplify loading and unloading truck deck.



Control System

Dual operator platforms are equipped with four single-lever crane controls arranged to ANSI B30.5 standards. Fully proportional control valves and system pressure gauge. Each station also includes outrigger and stabilizer controls, engine start/stop, foot throttle, signal horn, boom-angle indicator, bubble levels, load chart and range diagram.



Hydraulics

Hydraulic System – A 3-section vane pump direct-mounted to power take-off on truck transmission provides 42 gpm (159 lpm) to the hoist, 28 gpm (106 lpm) to the boom hoist and telescope circuit, and 12 gpm (45 lpm) to the swing and outrigger circuit. 100-gallon (379-liter) baffled reservoir includes suction ball valve with strainer two 25-micron filters in the return line. Use of SAE O-ring and face seal O-ring hydraulic fittings throughout system.

Hydraulic Cylinders – All load-holding cylinders are equipped with integral holding valves.



Warning Systems

Load Moment Indicator – Senses boom hoist cylinder pressure, boom length and boom angle. Audio-visual warning indicated overload conditions and overload shutoff feature prevents continuing overload. Operator can access all relative crane configuration and load conditions via display at the operator station.

Anti-Two-Block System – Audible warning and shutoff functions prevent hook from contacting boom point.

Back-Up Alarm – Supplied on factory-mounted cranes, electronic audible motion alarm activated when truck transmission is in reverse gear.



General

Electrical – State-of-the-art, weather-resistant components throughout. Automotive style electrical system for easy

models 30100C, 30124C



specifications

installation. Designed to withstand high pressure washing and varying climates.

Design/Welding – Design conforms to ANSI B30.5. Welding conforms to AWS D1.1. Tested to SAE 1063 and SAE 765.

Manuals – Operator, service and parts manuals depict correct crane operation, maintenance procedures and parts listing.

Warranty – 12-month warranty covers parts and labor resulting from defects in material and workmanship.

Warning

1. The operator must read and understand the owner's manual before operating this crane.
2. Positioning or operation of crane beyond areas shown on this chart is not intended or approved except where specified in owner's manual.
3. Loaded boom angles at specified boom lengths give only an approximation of the operating radius. The boom angle before loading should be greater to account for deflections. Do not exceed the operating radius for rated loads.
4. The operating radius shown in the jib rating chart is for fully extended boom only. When boom is not fully extended, use only loaded boom angle to determine load rating of jib.
5. For boom angles shown on jib load rating chart, use rating of next lower boom angle.
6. For boom lengths not shown, use rating of next shorter or longer boom length, whichever is less. For radii not shown, use rating of next longer radius.
7. Crane load ratings on outriggers are based on freely suspended loads with the machine leveled and standing on a firm, uniform supporting surface. No attempt shall be made to move a load horizontally on the ground in any direction.
8. Practical working loads depend on supporting surface, wind, and other factors affecting stability such as hazardous surroundings, experience of personnel, and proper handling, all of which must be taken into account by the operator.
9. The maximum load which may be telescoped is limited by hydraulic pressure, boom angle, and boom lubrication. It is safe to attempt to telescope any load within the limits of the load rating chart.

10. Lifting off the main boom point while the swing-around jib is erected is not intended or approved.

11. All load ratings above the heavy line are based on machine structural competence and do not exceed 85% of tipping. Load ratings below are stability limited and do not exceed 85% of tipping.

12. Do not operate a Manitowoc truck-mounted crane or accessories within 10' (3,05 m) of live power lines.

13. This capacity chart is for reference only and must not be used for specific serial number cranes.

Information

1. Deductions must be made from rated loads for stowed jib, optional attachments, hooks, and loadblocks (see deduction chart). Weights of slings and all other load-handling devices shall be considered a part of the load.
2. Load ratings above the heavy line are structurally limited capacities. Load ratings below the heavy line are stability limited capacities and do not exceed 85% of tipping.

Definitions

1. Operating radius (r) is the horizontal distance from the axis of rotation to the center of the vertical hoist line or tackle with load applied (see below).

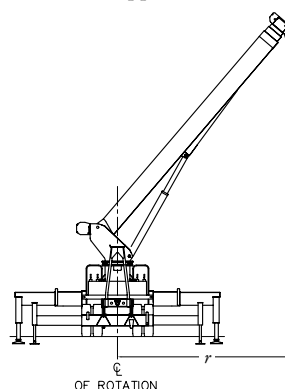

2. Loaded boom angle (\angle), as shown in the column headed by \angle , is the included angle between the horizontal and longitudinal axis of the boom base after lifting rated load at rated radius (see below).

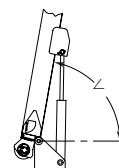

NOTE: Due to continuing improvements, Manitowoc Boom Trucks reserves the right to change product specifications without notice.



outline dimensions

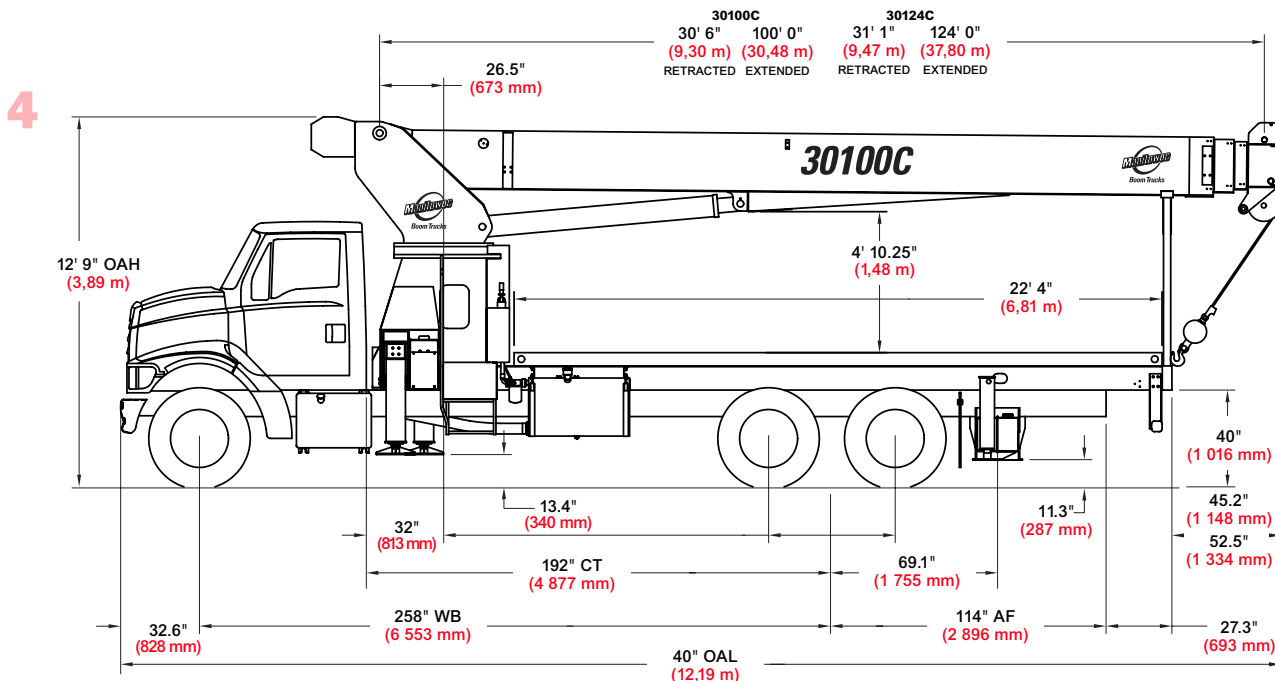

Chassis Data

Minimum Truck Requirements	30100C	30124C
Wheelbase (WB)	258" (6 553 mm)	258" (6 553 mm)
Cab to Tandem (CT)	192" (4 877 mm)	192" (4 877 mm)
After Frame (AF)	114" (2 896 mm)	114" (2 896 mm)
Frame Section Modulus at 180° Area of Operation	25.0 in³ 110,000 psi (758 450 kPa)	25.0 in³ 110,000 psi (758 450 kPa)
Frame Section Modulus at 360° Area of Operation*	33.0 in³ 110,000 psi (758 450 kPa)	33.0 in³ 110,000 psi (758 450 kPa)
Front Axle Gross Weight Rating	18,000 lb (8 165 kg)	18,000 lb (8 165 kg)
Rear Axle Gross Weight Rating	40,000 lb (18 144 kg)	40,000 lb (18 144 kg)
Minimum Truck Axle Weight - Front**	8,100 lb (3 674 kg)	9,200 lb (4 173 kg)
Minimum Truck Axle Weight - Back**	8,300 lb (3 765 kg)	8,300 lb (3 765 kg)
Nominal Frame Width	34" (864 mm)	34" (864 mm)

*Frame section modules at 360° area of operation requires front bumper stabilizer.

**Minimum chassis weight is required to meet 85% stability requirements.

Chassis data is general – not for engineering. Some dimensions depend on truck selection.

OAH Overall Height
 CT Cab to Tandem
 CA Cab to Axle
 WB Wheel Base
 OAL Overall Length
 BBC Bumper to Back of Cab
 AF Afterframe

models 30100C, 30124C



Weights

	30100C	30124C
Total Crane - Out-and-Down Outriggers	27,166 lb (12 323 kg)	28,586 lb (12 967 kg)
22' (6,71 m) Flat Bed	2,000 lb (907 kg)	2,000 lb (907 kg)
30' 6" (9,30 m) Fixed Length Jib	1,126 lb (511 kg)	—
31' (9,45 m) Fixed Length Jib	—	850 lb (386 kg)
30' 6"-55' (9,30 m-16,80 m) Telescopic Jib	1,754 lb (796 kg)	—



outline dimensions

5

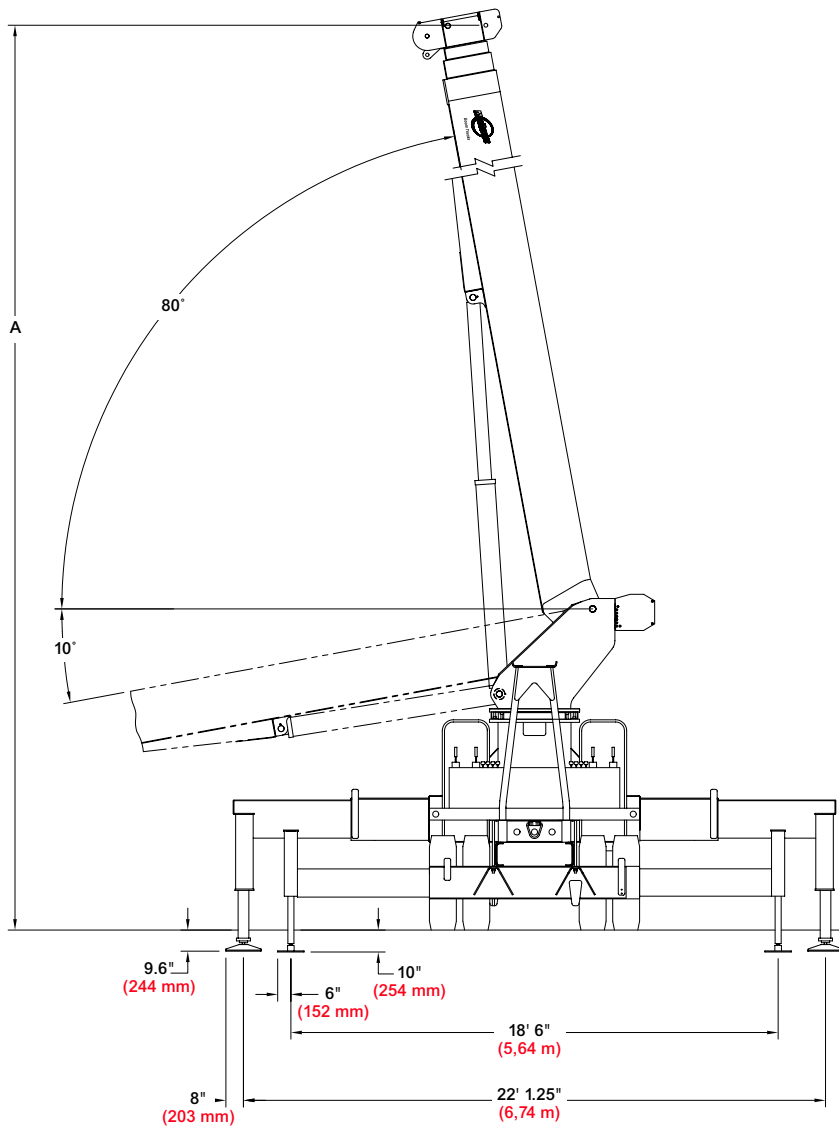

Maximum Tip Height (A)

Configuration	30100C	30124C
	Boom 100' (30,5 m)	Boom 124' (37,8 m)
Extended Boom	111' 4" (33,9 m)	134' 8" (41,1 m)
Fixed or Retracted Jib	142' 1" (43,3 m)	165' 11" (50,6 m)
Extended Jib	166' 8" (50,8 m)	—

models 30100C, 30124C



boom/jib range diagram

6

30100C Range Diagram - Fully Extended

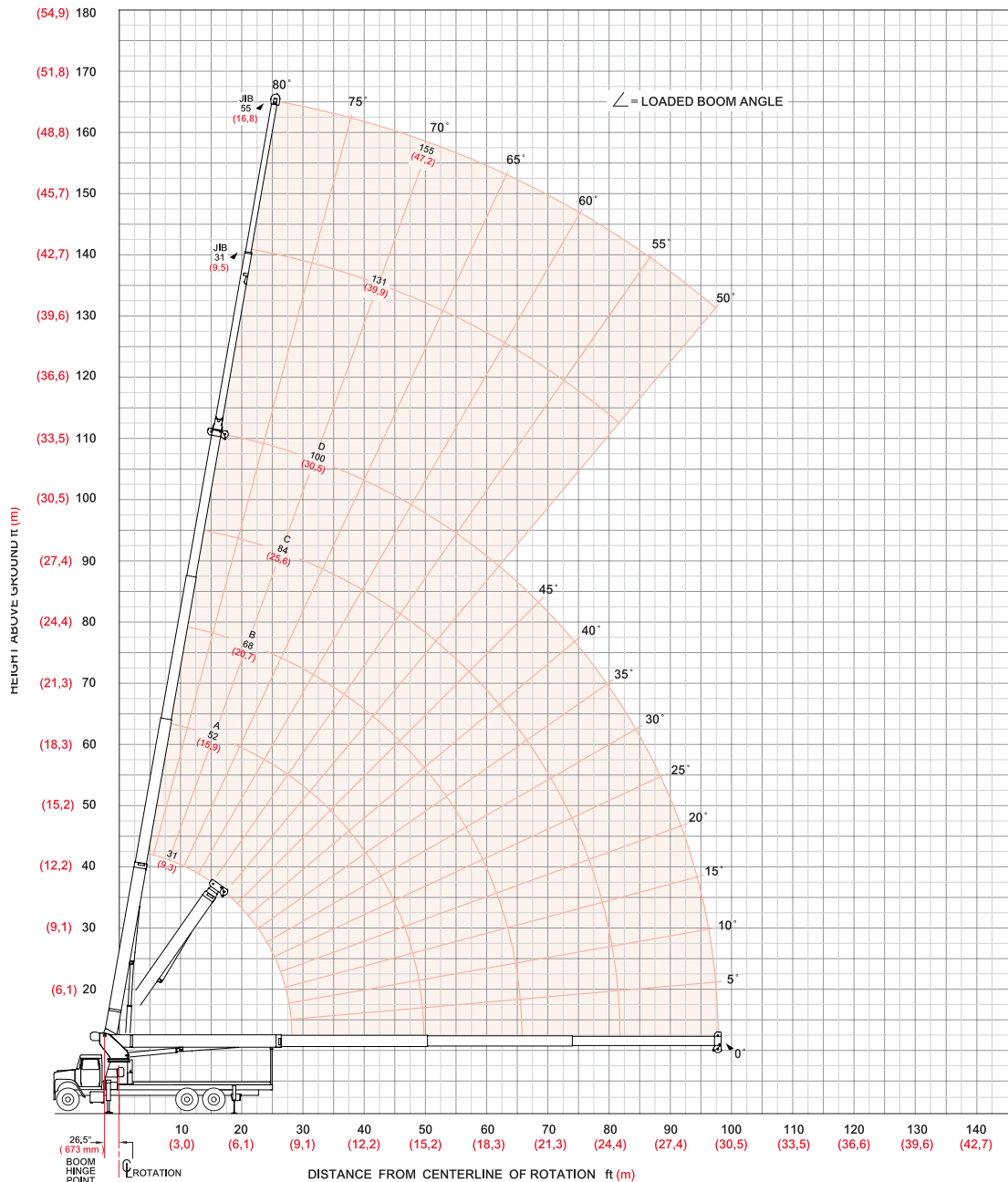

model 30100C

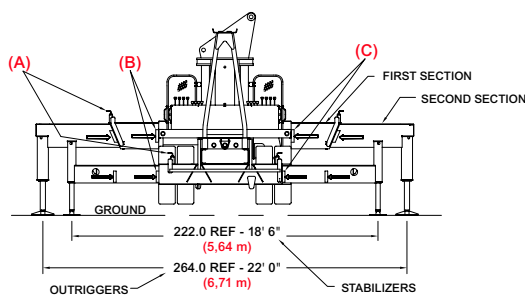

- (A) Pins must be disengaged for this outrigger configuration
- (B) These marks indicate when beams are fully extended
- (C) All outrigger beams must be extended to full extend mark

NOTE: Use this chart only when outriggers and stabilizers are fully extended.



boom/jib load charts

7

30100C Load Ratings - Fully Extended Outrigger Spread

30100C Jib Load Ratings

30100C Load Ratings - Fully Extended Outrigger Spread						30100C Jib Load Ratings											
Boom ft (m)	A		B		C		D		Fixed Jib		Telescopic Jib		Boom ft (m)				
	31 (9,5)	52 (15,9)	68 (20,7)	84 (25,6)	100 (30,5)	31 (9,5)	31 (9,5)	55 (16,8)	31 (9,5)	55 (16,8)							
Operating Radius ft (m)	∠	lb (kg)	∠	lb (kg)	∠	lb (kg)	∠	lb (kg)	∠	lb (kg)	∠	lb (kg)	Operating Radius ft (m)				
6 (1,8)	80°	60,000 (27 216)											6 (1,8)				
8 (2,4)	75°	45,200 (20 502)											8 (2,4)				
10 (3,1)	71°	38,700 (17 554)											10 (3,1)				
12 (3,7)	67°	33,800 (15 331)	78°	27,100 (12 292)									12 (3,7)				
15 (4,6)	61°	28,600 (12 973)	74°	25,200 (11 431)	79°	23,300 (10 569)							15 (4,6)				
20 (6,1)	48°	22,500 (10 206)	68°	19,800 (8 981)	74°	18,320 (8 310)	78°	17,040 (7 729)	80°	14,000 (6 350)			20 (6,1)				
25 (7,6)	32°	16,970 (7 697)	62°	16,220 (7 357)	70°	14,940 (6 777)	74°	13,940 (6 323)	78°	12,260 (5 561)			25 (7,6)				
30 (9,1)			55°	13,660 (6 196)	65°	12,580 (5 706)	71°	11,650 (5 284)	75°	10,680 (4 844)	79°	6,700 (3 039)	79°	6,400 (2 903)	30 (9,1)		
35 (10,7)			48°	11,140 (5 053)	60°	10,850 (4 921)	67°	10,050 (4 559)	72°	9,280 (4 209)	76°	6,200 (2 812)	76°	5,850 (2 654)	80°	4,000 (1 814)	35 (10,7)
40 (12,2)			39°	8,650 (3 924)	55°	8,790 (3 987)	63°	8,700 (3 946)	69°	8,110 (3 679)	74°	5,630 (2 554)	74°	5,250 (2 381)	78°	3,850 (1 746)	40 (12,2)
45 (13,7)			28°	6,750 (3 062)	49°	6,910 (3 134)	59°	7,030 (3 189)	65°	7,080 (3 211)	72°	5,060 (2 295)	72°	4,670 (2 118)	76°	3,700 (1 678)	45 (13,7)
50 (15,2)					43°	5,500 (2 495)	55°	5,630 (2 554)	62°	5,700 (2 585)	70°	4,560 (2 068)	70°	4,160 (1 887)	74°	3,550 (1 610)	50 (15,2)
55 (16,8)					36°	4,400 (1 996)	50°	4,530 (2 055)	59°	4,610 (2 091)	67°	4,130 (1 873)	67°	3,710 (1 683)	72°	3,310 (1 501)	55 (16,8)
60 (18,3)					27°	3,530 (1 601)	46°	3,650 (1 656)	55°	3,740 (1 696)	65°	3,730 (1 692)	65°	3,300 (1 497)	70°	3,020 (1 370)	60 (18,3)
65 (19,8)					12°	2,790 (1 266)	40°	2,950 (1 338)	51°	3,030 (1 374)	63°	3,300 (1 497)	63°	2,860 (1 297)	68°	2,730 (1 238)	65 (19,8)
70 (21,3)							34°	2,350 (1 066)	47°	2,440 (1 107)	60°	2,710 (1 229)	60°	2,300 (1 043)	66°	2,480 (1 125)	70 (21,3)
75 (22,9)							27°	1,850 (839)	43°	1,940 (880)	57°	2,200 (998)	57°	1,800 (816)	64°	2,240 (1 016)	75 (22,9)
80 (24,4)							15°	1,410 (640)	38°	1,510 (685)	55°	1,760 (798)	55°	1,370 (621)	62°	2,030 (921)	80 (24,4)
85 (25,9)									33°	1,130 (513)	52°	1,390 (630)	52°	990 (449)	60°	1,670 (757)	85 (25,9)
90 (27,4)									26°	800 (363)	49°	1,060 (481)	49°	660 (299)	57°	1,340 (608)	90 (27,4)
95 (29,0)											46°	770 (349)			55°	1,040 (472)	95 (29,0)
100 (30,5)															53°	780 (354)	100 (30,5)
Deduction*		600 (272)	350 (159)	270 (122)	220 (100)	180 (82)											
Deduction**		900 (408)	530 (240)	400 (181)	330 (150)	290 (132)											

*for stowed fixed jib

**for stowed telescopic jib

Meets ANSI B30.5 Requirements - Do not operate crane or accessories within 10' (3.05m) of live power lines.
 NOTICE: This capacity chart is for reference only and must not be used for lifting purposes.



model 30100C

boom/jib range diagram

8

30100C Range Diagram - Intermediate

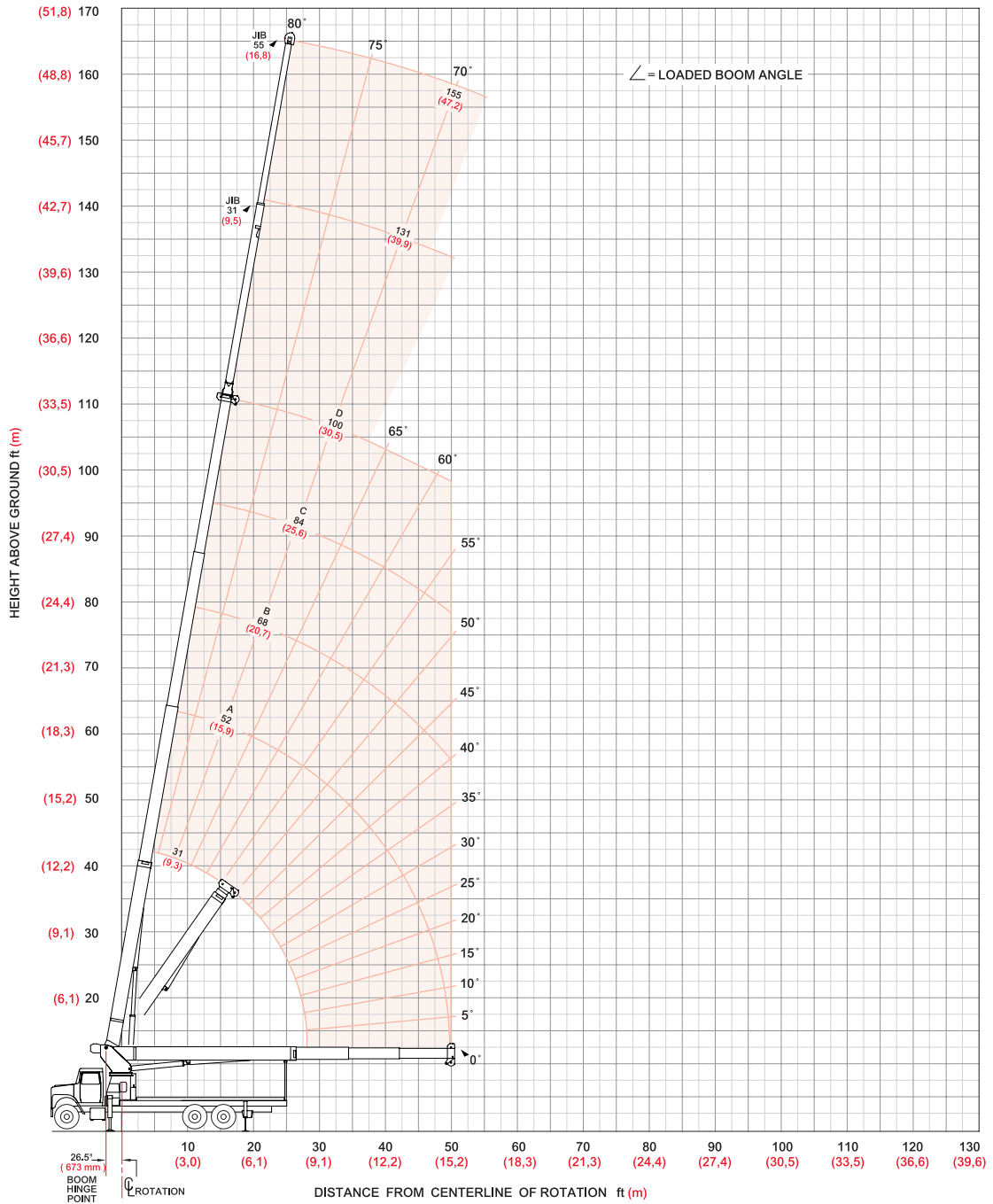

model 30100C

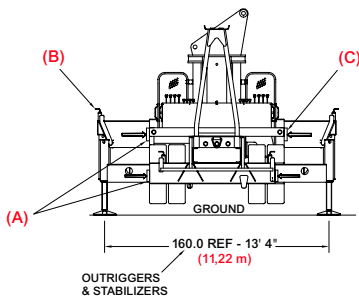

- (A) Mark indicates beams are mid extended
- (B) Pins must be engaged for this outrigger and stabilizer configuration
- (C) Both outrigger and stabilizer beams must be extended to mid extend mark

NOTE: Lifting personnel with crane in this outrigger configuration is strictly prohibited. Use only fully extended outrigger configuration when lifting personnel.

Use this chart only when front outriggers and rear stabilizers are in the intermediate position.



boom/jib load charts

30100C Load Ratings - Intermediate Outrigger Spread

30100C Jib Load Ratings

30100C Load Ratings - Intermediate Outrigger Spread						30100C Jib Load Ratings								
Boom/Jib ft (m)	A		B		C		D		Fixed Jib		Telescopic Jib		Boom/Jib ft (m)	
	31 (9,5)	52 (23,0)	68 (20,7)	84 (25,6)	100 (30,5)	31 (9,5)	31 (9,5)	55 (16,8)	31 (9,5)	55 (16,8)				
Operating Radius ft (m)	∠	lb (kg)	∠	lb (kg)	∠	lb (kg)	∠	lb (kg)	∠	lb (kg)	∠	lb (kg)	Operating Radius ft (m)	
6 (1,8)	80°	60,000 (27 216)											6 (1,8)	
8 (2,4)	75°	45,200 (20 503)											8 (2,4)	
10 (3,0)	71°	38,700 (17 554)											10 (3,0)	
12 (3,7)	67°	33,800 (15 332)	78°	27,100 (12 293)									12 (3,7)	
15 (4,3)	61°	21,900 (9 934)	74°	22,640 (10 270)	79°	22,880 (10 378)							15 (4,3)	
20 (5,2)	48°	11,910 (5 402)	68°	12,530 (5 684)	74°	12,730 (5 774)	78°	12,860 (5 833)	80°	12,940 (5 870)			20 (5,2)	
25 (6,1)	32°	7,360 (3 338)	62°	7,940 (3 602)	70°	8,120 (3 683)	74°	8,230 (3 733)	78°	8,300 (3 765)			25 (6,1)	
30 (7,6)			55°	5,310 (2 409)	65°	5,480 (2 486)	71°	5,580 (2 531)	75°	5,650 (2 563)	79°	5,830 (2 644)	79°	5,410 (2 454)
35 (9,1)			48°	3,610 (1 637)	60°	3,770 (1 710)	67°	3,870 (1 755)	72°	3,930 (1 783)	76°	4,110 (1 864)	76°	3,680 (1 669)
40 (10,7)			39°	2,420 (1 098)	55°	2,580 (1 170)	63°	2,670 (1 211)	69°	2,730 (1 238)	74°	2,900 (1 315)	74°	2,470 (1 120)
45 (12,2)			28°	1,540 (699)	49°	1,690 (767)	59°	1,780 (807)	65°	1,840 (835)	72°	2,000 (907)	72°	1,580 (717)
50 (13,7)					43°	1,010 (458)	55°	1,100 (499)	62°	1,160 (526)	70°	1,320 (599)	70°	890 (404)
55 (15,2)													72°	1,040 (472)
Deduction*		600 (272)		350 (159)		270 (122)		220 (100)		180 (82)				
Deduction**		900 (408)		530 (240)		400 (181)		330 (150)		290 (132)				

*for stowed fixed jib

**for stowed telescopic jib

Meets ANSI B30.5 Requirements - Do not operate crane or accessories within 10' (3.05m) of live power lines.
 NOTICE: This capacity chart is for reference only and must not be used for lifting purposes.

model 30100C



boom/jib range diagram

10

30124C Range Diagram - Fully Extended

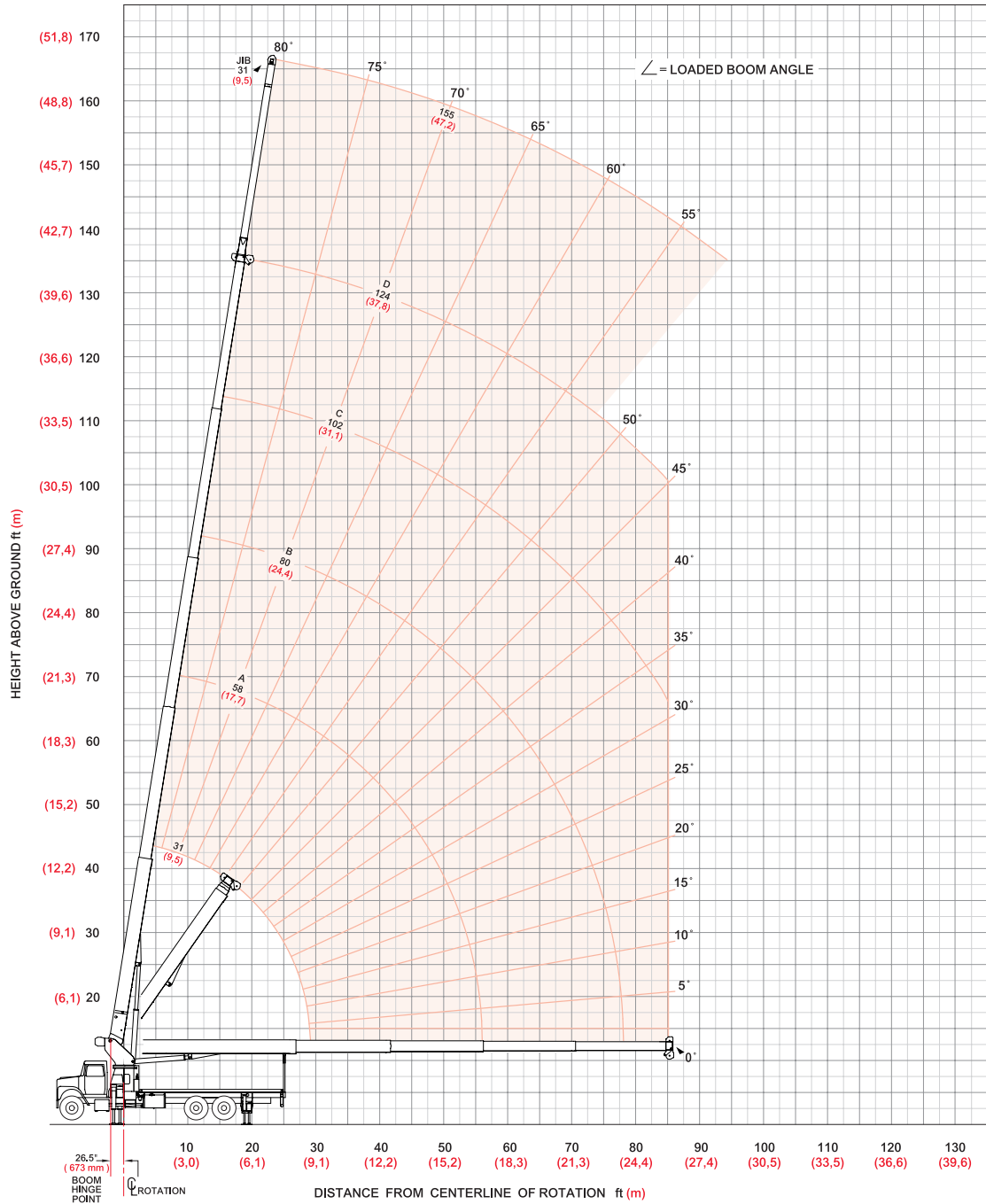

model 30124C

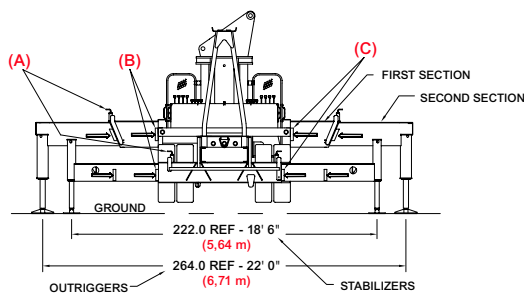

- (A) Pins must be disengaged for this outrigger configuration
- (B) These marks indicate when beams are fully extended
- (C) All outrigger beams must be extended to full extend mark

NOTE: Use this chart only when outriggers and stabilizers are fully extended.



boom/jib load charts

11

30124C Load Ratings - Fully Extended Outrigger Spread

30124C Jib Load Ratings

		A		B		C		D				
Boom/Jib ft (m)		31 (9,5)		58 (17,7)		80 (24,4)		102 (31,1)		124 (37,8)		
Operating Radius ft (m)	∠	lb (kg)		lb (kg)		lb (kg)		lb (kg)		lb (kg)		
		∠	∠	∠	∠	∠	∠	∠	∠	∠	∠	
6 (1,8)	81°	60,000 (27 216)										
8 (2,4)	76°	46,600 (21 137)										
10 (3,0)	72°	39,300 (17 826)										
12 (3,7)	68°	34,200 (15 513)	79°	25,000 (11 340)								
15 (4,6)	61°	28,620 (12 982)	76°	25,000 (11 340)	81°	21,000 (9 525)						
20 (6,1)	49°	21,500 (9 752)	71°	19,490 (8 841)	78°	18,520 (8 401)	81°	14,000 (6 350)				
25 (7,6)	34°	16,110 (7 307)	65°	15,760 (7 149)	74°	14,700 (6 668)	79°	13,000 (5 897)	81°	8,450 (3 833)		
30 (9,1)			60°	13,040 (5 915)	70°	12,070 (5 475)	76°	11,420 (5 180)	79°	8,150 (3 697)	81°	4,000 (1 814)
35 (10,7)			53°	10,430 (4 731)	66°	10,130 (4 595)	73°	9,600 (4 354)	76°	7,800 (3 538)	79°	3,850 (1 746)
40 (12,2)			47°	8,470 (3 842)	62°	8,620 (3 910)	69°	8,120 (3 683)	74°	7,280 (3 302)	77°	3,700 (1 678)
45 (13,7)			39°	6,560 (2 976)	57°	6,750 (3 062)	66°	6,850 (3 107)	72°	6,540 (2 966)	75°	3,550 (1 610)
50 (15,2)			29°	5,130 (2 327)	52°	5,310 (2 409)	63°	5,410 (2 454)	69°	5,460 (2 477)	73°	3,400 (1 542)
55 (16,8)			13°	4,020 (1 823)	47°	4,200 (1 905)	59°	4,290 (1 946)	66°	4,340 (1 969)	71°	3,250 (1 474)
60 (18,3)					42°	3,310 (1 501)	56°	3,400 (1 542)	64°	3,450 (1 565)	69°	3,080 (1 397)
65 (19,8)					36°	2,590 (1 175)	52°	2,680 (1 216)	61°	2,730 (1 238)	67°	2,910 (1 320)
70 (21,3)					28°	1,990 (903)	48°	2,080 (943)	58°	2,120 (962)	66°	2,490 (1 129)
75 (22,9)					18°	1,480 (671)	44°	1,570 (712)	55°	1,610 (730)	64°	1,970 (894)
80 (24,4)							39°	1,130 (513)	52°	1,180 (535)	62°	1,530 (694)
85 (25,9)							34°	760 (345)	49°	800 (363)	60°	1,150 (522)
90 (27,4)											57°	820 (372)
95 (29,0)											55°	530 (240)
Deduction*		450 (204)	240 (109)	180 (82)	140 (64)	120 (54)						

*for stowed fixed jib

Meets ANSI B30.5 Requirements - Do not operate crane or accessories within 10' (3.05m) of live power lines.
 NOTICE: This capacity chart is for reference only and must not be used for lifting purposes.

model 30124C



boom/jib range diagram

12

30124C Range Diagram - Intermediate

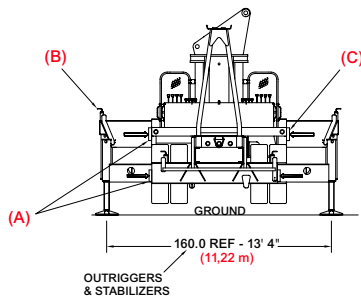
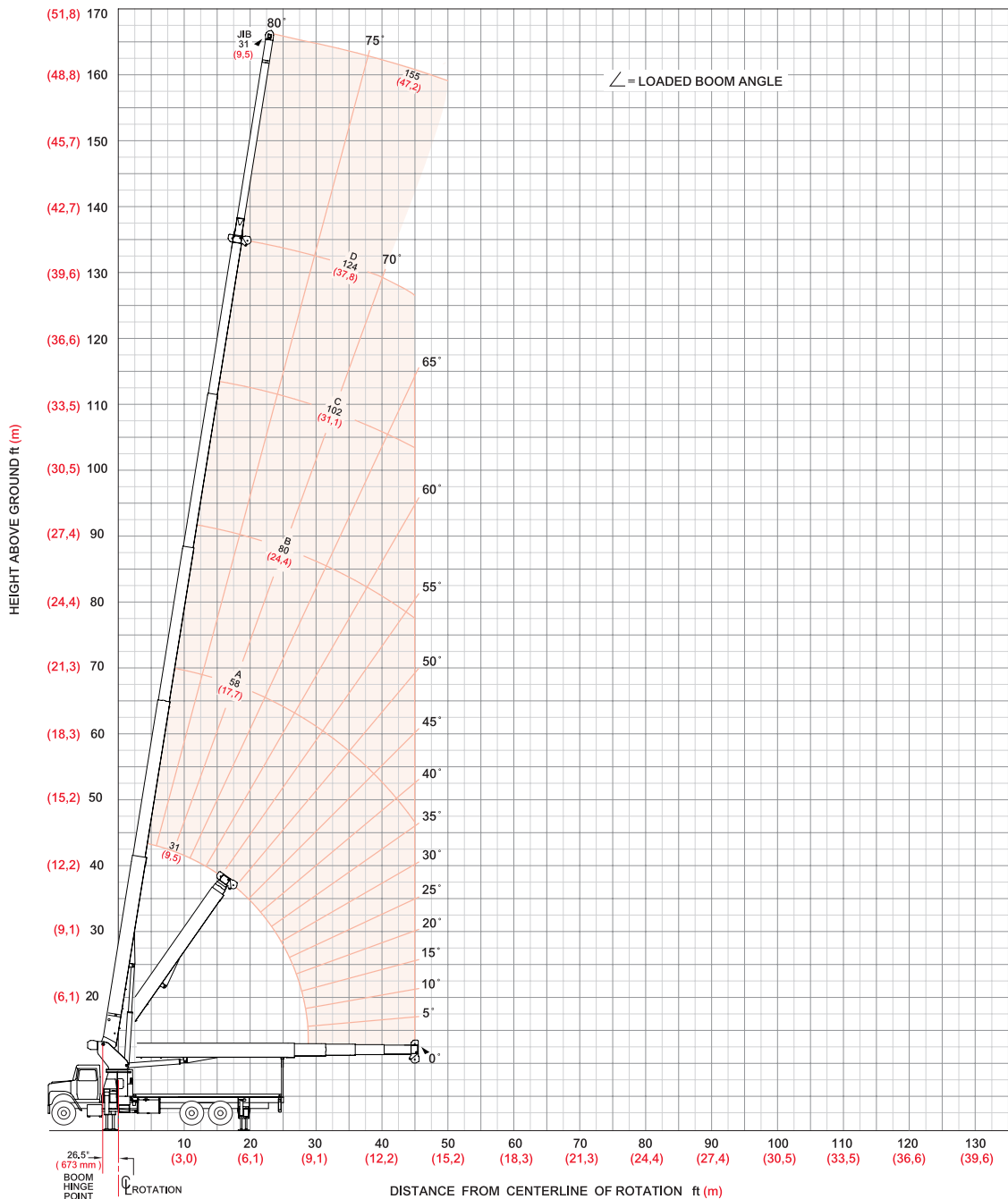

- (A) Mark indicates beams are mid extended
- (B) Pins must be engaged for this outrigger and stabilizer configuration
- (C) Both outrigger and stabilizer beams must be extended to mid extend mark

NOTE: Lifting personnel with crane in this outrigger configuration is strictly prohibited. Use only fully extended outrigger configuration when lifting personnel.

Use this chart only when front outriggers and rear stabilizers are in the intermediate position.

model 30124C



boom/jib load charts

13

30124C Load Ratings - Intermediate Outrigger Spread

30124C Jib Load Ratings

Boom/Jib ft (m)	A					B					C					D					Fixed Jib		
	31 (9,5)	58 (17,7)	80 (24,4)	102 (31,1)	124 (37,8)	31 (9,5)	58 (17,7)	80 (24,4)	102 (31,1)	124 (37,8)	31 (9,5)	58 (17,7)	80 (24,4)	102 (31,1)	124 (37,8)	31 (9,5)	58 (17,7)	80 (24,4)	102 (31,1)	124 (37,8)	31 (9,5)	58 (17,7)	
Operating Radius ft (m)	∠	∠	∠	∠	∠	∠	∠	∠	∠	∠	∠	∠	∠	∠	∠	∠	∠	∠	∠	∠	∠	∠	Operating Radius ft (m)
6 (1,8)	81°	60,000 (27 216)																					6 (1,8)
8 (2,4)	76°	46,600 (21 138)																					8 (2,4)
10 (3,1)	72°	39,300 (17 826)																					10 (3,1)
12 (3,7)	68°	34,200 (15 513)	79°	25,000 (11 340)																			12 (3,7)
15 (4,6)	61°	22,520 (10 215)	76°	23,390 (10 610)	81°	21,000 (9 526)																	15 (4,6)
20 (6,1)	49°	12,070 (5 475)	71°	12,800 (5 806)	78°	13,020 (5 906)	81°	13,140 (5 960)															20 (6,1)
25 (7,6)	34°	7,300 (3 311)	65°	7,990 (3 624)	74°	8,180 (3 710)	79°	8,290 (3 760)	81°	8,350 (3 788)													25 (7,6)
30 (9,1)			60°	5,230 (2 372)	70°	5,420 (2 459)	76°	5,510 (2 499)	79°	5,570 (2 527)	81°	4,000 (1 814)											30 (9,1)
35 (10,7)			53°	3,450 (1 565)	66°	3,630 (1 647)	73°	3,720 (1 687)	76°	3,770 (1 710)	79°	3,850 (1 746)											35 (10,7)
40 (12,2)			47°	2,200 (998)	62°	2,380 (1 080)	69°	2,460 (1 116)	74°	2,510 (1 139)	77°	2,820 (1 279)											40 (12,2)
45 (13,7)			39°	1,280 (581)	57°	1,450 (658)	66°	1,530 (694)	72°	1,580 (717)	75°	1,890 (857)											45 (13,7)
50 (15,2)											73°	1,170 (531)											50 (15,2)
Deduction*		450 (204)		240 (109)		180 (82)		140 (64)		120 (54)													

*for stowed fixed jib

Meets ANSI B30.5 Requirements - Do not operate crane or accessories within 10' (3.05m) of live power lines.
 NOTICE: This capacity chart is for reference only and must not be used for lifting purposes.



model 30124C

load chart data

14

Deductions

Auxiliary Block	50 lb (23 kg)
Load Block	See manufacturer's nameplate
Overhaul Ball	See manufacturer's nameplate
Hose Reel	260 lb (118 kg)
Swing Around Jib* (Stowed)	See load rating chart

Warning

Anti-two-block system must be in good operating condition before operating crane. Refer to the owner's manual. Keep at least three wraps of load line on the drum at all times.

Area of Operation

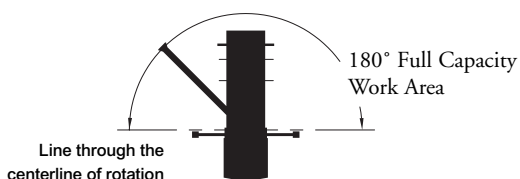

Allowable Line Pull 30100C

1 Part Line	2 Part Line	3 Part Line	4 Part Line	5 Part Line	6 Part Line
9,080 lb (4 119 kg)	18,160 lb (8 237 kg)	27,240 lb (12 356 kg)	36,320 lb (16 474 kg)	45,000 (20 593 kg)	54,480 (24 712 kg)
10,000 lb (4 536 kg)	20,000 lb (9 072 kg)	30,000 lb (13 608 kg)	40,000 lb (18 144 kg)	50,000 lb (22 680)	60,000 lb (27 216 kg)

Allowable Line Pull 30124C

1 Part Line	2 Part Line	3 Part Line	4 Part Line	5 Part Line	6 Part Line	7 Part Line
9,080 lb (4 119 kg)	18,160 lb (8 237 kg)	27,240 lb (12 356 kg)	36,320 lb (16 474 kg)	45,400 (20 593 kg)	54,480 (24 712 kg)	60,000 (27 216 kg)
9,500 lb (4 309 kg)	19,000 lb (8 618 kg)	28,500 lb (12 927 kg)	38,000 lb (17 237 kg)	47,500 lb (21 546)	57,000 lb (25 855 kg)	60,000 (27 216 kg)

5/8" Rotation Resistant (5.0:1 SF) – 45,400 lb Min Breaking Strength
 5/8" 6x25 IWRC (3.5:1 SF) – 35,000 lb Min Breaking Strength

models 30100C, 30124C



CraneCARESM

CraneCARE is Manitowoc Boom Trucks' complete service and support program. Incorporated into this program are service training, immediate parts availability, professional field service, and technical support and documentation. CraneCARE is available for every one of the thousands of cranes still operating all over the world.

That's dedication and devotion that you won't get anywhere else.

That's **CraneCARE**.

Service Training

A certified Manitowoc Boom Trucks service specialist works with you in your training facility or in the field to ensure that you know how to achieve maximum performance, dependability, and years from your cranes.

A reputable Manitowoc Boom Trucks Service technician comes to you to provide valuable training to all distributors on the crane's LMI system.

Parts Availability

Genuine Manitowoc Boom Trucks replacement parts may be obtained through your MBT distributor on a regular basis.

Hydraulic Test Kit with Case – Part No. 499792-9

- Small national O-ring kit
- Pressure gauges
- Fluke multi-meter
- Hydraulic flow meters
- Multi-load grease gun
- 6-drawer tool box
- 17-piece wrench set

Field Service

Factory-trained service experts are always ready to help maintain your crane's peak performance.

For a worldwide listing of dealer locations, please consult our website at: www.manitowocbt.com.

Technical Support

Manitowoc Boom Trucks' dealer network and factory personnel are available 24 hours a day, 7 days a week, 365 days a year to answer your technical questions and more.

For a worldwide listing of dealer locations, please consult our website at: www.manitowocbt.com.

Technical Documentation

Manitowoc Boom Trucks boast an extensive, easy-to-understand library of documentation.

A complete set of Operator's parts and service manuals are included with each crane.

Additional copies are available through your Authorized Manitowoc Boom Trucks Distributor.

15

Bigge Crane and Rigging Co.

10700 Bigge Avenue
San Leandro, CA 94577
Phone: (888) 337-BIGGE or (510) 638-8100
Fax: (510) 639-4053
Email: info@bigge.com
Web site: www.bigge.com



models 30100C, 30124C

