

## LS-308H II

### HYLAB Series

#### Lattice Boom Crawler Crane 110-ton (99.79 mt)

- 110-ton (99.79 mt) at 12' (3.66 m) radius
- Powerhouse package:
  - 1-1/8" wire rope, front & rear drums
  - 37,100 lbs (16 828 kg) allowable line pull
  - 55,000 lbs (24 948 kg) available line pull
  - Automatic brake with true freefall
  - Attachments for lift crane, drag line and clam
  - 332 hp equipped with total horsepower control
- Rugged angle boom attachment for severe duty applications
- Separate engine/hydraulic cooling
- Remote/dedicated hydraulic circuit\*
- 4th drum with freefall\*
- Remote hydraulic cooling for auxiliary attachment\*

\* optional

**Link-Belt**  
CONSTRUCTION EQUIPMENT



# LS-308H II

HYLAB Series

**Tough, duty cycle design for your most demanding job**

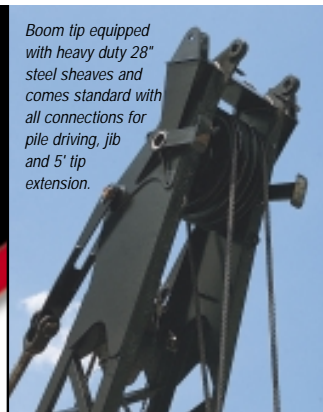

Boom tip equipped with heavy duty 28" steel sheaves and comes standard with all connections for pile driving, jib and 5' tip extension.



Fast attach bridle guide



Seamless welds and treated hardware throughout attachment



332 hp Mitsubishi engine



### Heavy duty boom hoist and hydraulic power meet your most demanding needs

- 1-1/8" rope - front and rear drums
- 37,100 lbs (16 828 kg) allowable line pull
- 55,000 lbs (24 948 kg) available line pull
- Big drum brakes — accessible, easy maintenance, adjustable for each individual operator
- 332 hp Mitsubishi engine provides plenty of reserve power to operate auxiliary hydraulic load
- Total horsepower control challenges the engine at all times to work at maximum speed to give you maximum power — a huge speed advantage over other cranes with bigger horsepower that do not use total horsepower control
- Remote hydraulic cooling
- Dedicated engine cooling
- Variety of counterweight configurations
- Optional high capacity 4th drum with true gravity freefall - 7/8"
- Optional front-mounted 3rd drum
- Optional auxiliary hydraulic power package for additional hydraulic supply for various attachments, controlled through a separate variable flow control valve in the operator's cab eliminates pump cavitation/contamination, common with hydraulic hammers. Nephron filter system filters out fine contaminants.

### Rugged attachments

- 50' - 160', 60" x 54" in-line pin-connected angle boom
- 32,250 lbs (14 628 kg) clam & drag ratings with 120' (36.58 m) of boom
- 220' (67.06 m) maximum tip height
- Heavy duty pendants
- Built to withstand side loads associated with duty cycle operation

### Operator's cab

- 18,650 BTU air conditioning and 19,000 BTU heating run through upper and lower vents
- Rated capacity limiter with load cell located in boom hoist dead end
- Pilot-operated single axis controls
- Twist-o-grip swing/throttle lever
- Low effort hydraulic brake pedals — minimal pedal travel
- Optional 4th drum foot pedal
- Optional variable flow auxiliary hydraulic circuit control

### Lower

- Self-cleaning 36" track shoes form an extra wide gauge of 17' 6"
- Quick-storage side frame steps
- Automatic hydraulic track tension
- Hydraulic side frame extension and retraction
- Turntable bearing with internal swing teeth, two position positive house lock
- Sealed track rollers, idler and drive planetaries and compact hydrostatic drives add up to outstanding reliability and maintenance-free operation
- Hydraulic jacks for fast, easy track removal



### Assembly/disassembly & transport

- Lifting sheaves in base section for self-assembly/disassembly
- Counterweights are hydraulically installed and coupled to upper
- Track quick disconnects can attach in minutes, no tools necessary
- Moves in four loads



Big horsepower, high flows and plenty of reserve power to operate auxiliary hydraulic demands



Main hydraulic system has separate cooler, hydraulically-driven fan. Cooler hydraulics — easier to maintain, longer lasting



Optional hydraulic package has separate reservoir and cooling.



Hydraulic hook-ups — 3rd drum, spotter circuits, auxiliary tool



© Link-Belt is a registered trademark. Copyright 2001. All rights reserved. We are constantly improving our products and therefore reserve the right to change designs and specifications. Litho in U.S.A. 8/01 #4264



**PRELIMINARY**

**Link-Belt**  
CONSTRUCTION EQUIPMENT

# Specifications

Lattice Boom Crawler Crane

## LS-308H II 110-ton (99.79 metric ton)

**HYLAB Series**

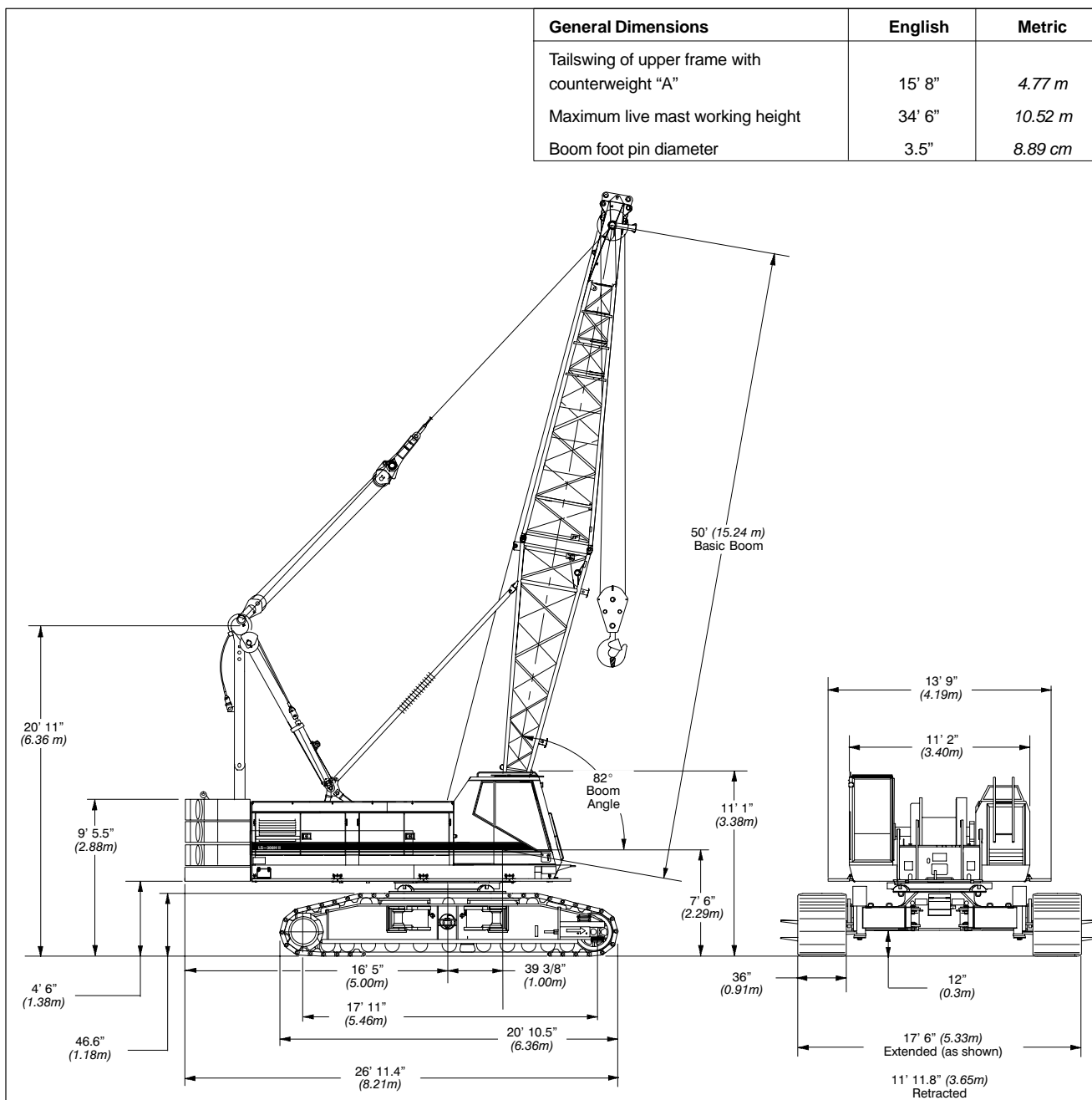

Litho in USA 9/01

**PRELIMINARY**

#5340



**LS-308H II Machine Transport Weights – approximate**

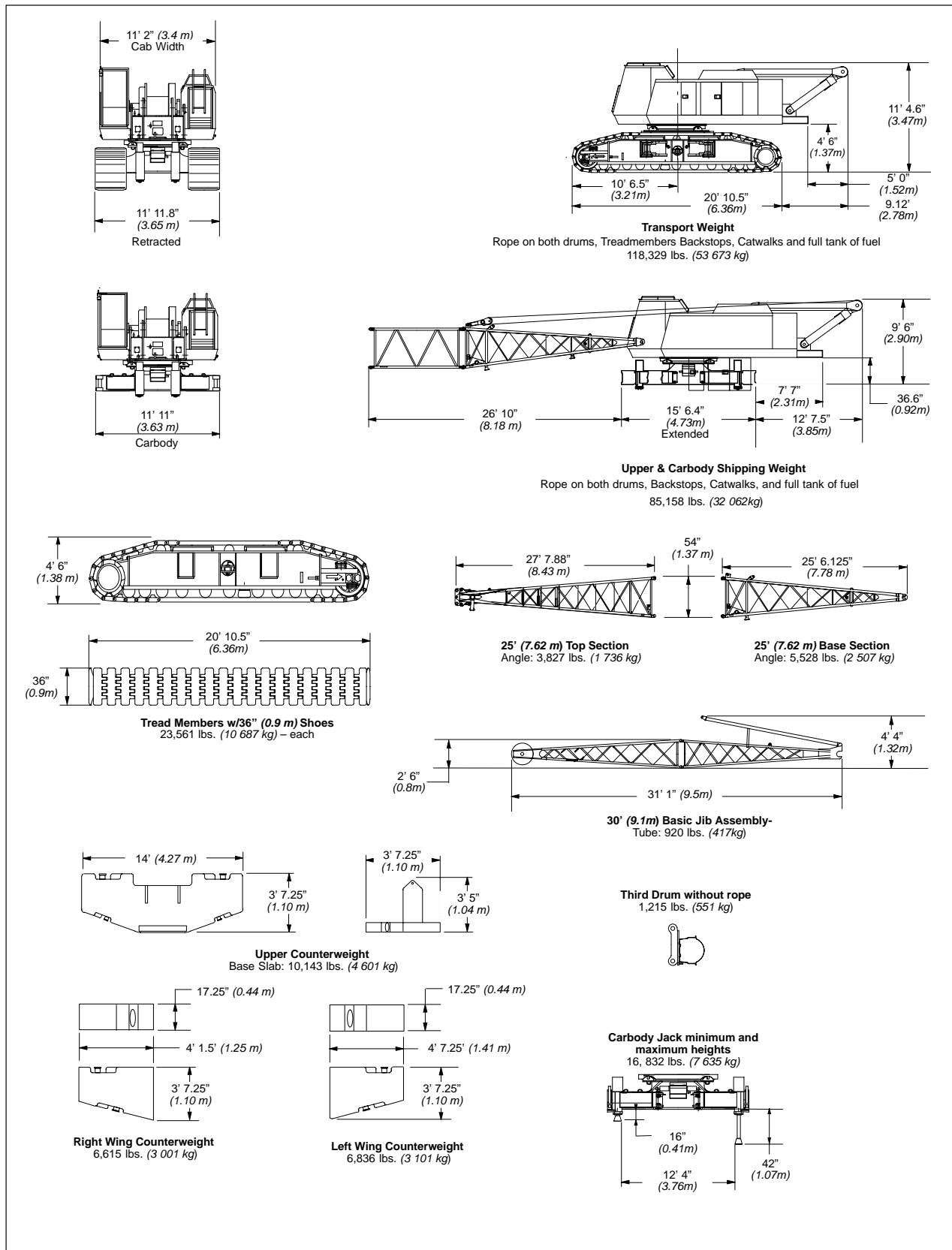

LS-308H II



# PRELIMINARY



## LS-308H II Transportation Weights – approximate

**Base Machine:** Rigid Boom Backstops, 77 Gallons (291L) of fuel, Catwalks (right and left side), 25' (6.1 m) Base Section, Bridle and Spreader Bar, Boom Hoist Reeving, 600' (182.88 m) of type 'DB' Front Hoist Rope, 500' (152.4 m) of type 'RB' Rear Hoist Rope.

Item Description	Gross Weight		Transport Loads				Notes and Load Summary
	lb.	kg.	#1	#2	#3	#4	
<b>Base Machine</b>	85,158	32 062	1				Numbers in the load columns to the left represent quantities.  Estimated transport assumes the load out consist of 230' (70.1m) of tube boom + 75' (22.86m) of jib with full counterweight.  Support loads were targeted at 45,000 lb (20 412kg), 8'-6" (2.6m) wide, 48' (14.6m) long, and 13'-6" (4.1m) high using a drop deck trailer. This may vary depending on state laws, empty truck/trailer weights, and style of trailer.  Estimated weights vary by +/- 2%.  <b>Estimated Total Load of #1</b> 85,158 lbs. (38 627 kg).  <b>Estimated Total Load of #2</b> 43,465 lbs. (19 715 kg).  <b>Estimated Total Load of #3</b> 43,065 lbs. (19 533 kg).  <b>Estimated Total Load of #4</b> 28,661 lbs. (13 454 kg)
Add "A" Counterweight (base cwt., 1 left wing and 1 right wing)	23,594	10 702				1	
Add "B" Counterweight (2 left wing and 2 right wing)	26,902	12 203		2	2		
Add Hydraulic Third Drum w/o rope	1,215	551					
Add 25' (7.62 m) Angle boom Top Section	3,827	1 644				1	
Add 25' (7.62 m) Three-sheave assembly to top section	284	129					
Add 25' (7.62 m) Angle boom Base Section	5,528	2 507					
Add 10' (3.05m) Angle Extension w/pins & pendants	1,600	726					
Add 20' (6.1m) Angle Extension w/pins & pendants	2,650	1,202		1	1		
Add 30' (9.1m) Angle Extension w/pins & pendants	3,625	1,644		1	1	1	
Add Tagline Winder w/rope	1,040	472					
Add Fairleader	1,213	550					
Add Pile Driving Adapter	198	90					
Add 30' (9.14 m) Tubular Jib	920	417				1	
Add 15' (4.57m) Tubular Jib Extension	320	145				1	
Add 5' (1.5m) Auxiliary Tip Extension	640	290					
Add Three-sheave Idler A/C	284	129					
Add 3rd Drum Wire Rope 0.63" x 385' Type 'ZB'	572	259					
Add 20-ton (18.14 mt) Hook Ball – Swivel or Non Swivel	1,253	568					
Add 75-ton (68.04 mt) 2-Sheave Hook Block	2,200	998					
Add 110-ton (100 mt) 3-Sheave Hook Block	2,385	1 082					
Remove Front Hoist Rope 0.75" x 600' Type 'DB'	-1,638	-743					
Remove Jib Wire Rope 0.75" X 500' Type 'RB'	-1,750	-794					
Remove 25' (7.62 m) Angle Base Section (Assy. complete)	-3,625	-1 636					
Remove 50 gallons (189.3L) of Fuel	-362	-164					

## LS-308H II Machine Working Weight

Option	Description	Gross Weight lbs. (kg)	Ground Bearing Pressure psi (kg/cm <sup>2</sup> )
1	Base Machine equipped with 50' (15.24 m) of angle boom, "A" counterweight, 700' (213 m) front hoist rope, 700' (198m) rear hoist rope, 110-ton (99.8mt) hook block, 132 gallons (500.4 L) of fuel, and 200 lbs. (90.7kg) operator.	158,800 (72 030)	10.26 (0.72)
2	Option #1 plus "B" counterweight, midpoint pendants, and 110' (33.53 m) of boom extensions to obtain 160' (48.77 m) of main boom.	199,425 (90 457)	12.88 (0.91)
3	Option #2 plus 75' (22.86 m) of jib and 20-ton (18.14 mt) hook ball – subtract 20' (6.1 m) of boom extension and midpoint pendants to obtain maximum 140' + 75' (42.7 + 22.9 m) of main boom + jib.	200,340 (90 872)	12.94 (0.91)

**Notes:**

- Ground bearing pressure is based on the total weight distributed evenly over the track contact area.
- Total contact area for 36" (0.91m) track shoes is 16,012 in<sup>2</sup> (1 126 cm<sup>2</sup>).

# PRELIMINARY



## Attachment Options

### ■ 50'–160' Angle Boom (15.24 – 48.77 m)

**Basic Angle Boom** – 50' (15.24 m) two-piece design that utilizes a 25' (7.62 m) base section and a 25' (7.62 m) top section with in-line connecting pins. Boom extensions are 60" (1.52 m) wide and 54" (1.37 m) deep at outside dimensions of angles.

- Boom feet on 47.25" (1.20 m) centers
- 4" X 4" X 0.5" (101.6 x 101.6 x 12.7 mm) angle chords
- Lugs on base section to attach carrying links
- Skywalk platform
- Deflector roller on top section
- Rigid sheave guards
- Tip extension and jib connecting lugs on top section
- Mechanical boom angle indicator
- Three 24.75" (0.63 m) root diameter lift sheaves mounted on sealed anti-friction bearings with rope guards.

#### Optional

- 25' (7.62 m) Dragline Base Section

#### Optional Head Machinery –

- Two 24.75" (0.63 m) root diameter lift sheaves mounted on sealed anti-friction bearings with three-piece rope guide rollers. For clamshell operations.
- Two 24.75" (0.63 m) root diameter lift sheaves and one 24.75" (0.63 m) wide mouth dragline sheave mounted on sealed anti-friction bearings with three-piece rope guide rollers. For lift crane and/or dragline operation.

- One 24.75" (0.63 m) root diameter lift sheaves with two-piece rope guide rollers. For dragline operation.

**Angle Boom Extensions** – The following table provides the lengths available and the suggested quantity to obtain maximum boom in 10' (3.05m) increments. Midpoint pendant connections are not required.

Angle Boom Extensions	Suggested Quantity for Max. Boom
10' (3.05m)	1
20' (6.10m)	2
30' (9.14m)	2

- Appropriate length pendants
- Maximum angle boom tip height of 166' (50.6 m)

### ■ 30' – 75' Tubular Jib (9.14 – 22.86 m)

**Basic Tube Jib** – 30' (9.14 m) two-piece design that utilizes a 15' (4.57 m) base section and a 15' (4.57 m) top section with in-line connecting pins on 32" (0.81 m) wide and 24" (0.61 m) deep centers.

- 2" (50.8 mm) diameter tubular chords
- One 20.64" (0.52 m) root diameter steel sheave mounted on sealed anti-friction bearings.

- 15' (4.6 m) jib extensions provide jib lengths at 45' (13.76m), 60' (18.3m) and 75' (22.86m) for tube boom. Angle boom is limited to 60' (18.29m).
- Jib offset angles at 10 and 30 degrees
- Maximum tip height angle boom + jib is 220' (67.1 m).

### ■ Auxiliary 5' Tip Extension (1.5m)

Designed to use in place of jib to provide clearance between working hoist lines. The extension is equipped with two nylon 18" (0.46m) root diameter sheaves mounted on sealed anti-friction bearings. Maximum capacity is 9-ton (8.16mt).

### ■ Boom Hoist System

Designed to lift off maximum boom or maximum boom plus jib unassisted. Operates up to a maximum boom angle of 82 degrees. Boom hoist limit system limits maximum boom angle operation.

- Retractable gantry frame
- Pin-on bail frame
- Ten-part reeving with 3/4" (19mm) wire rope
- Bridle assembly
- Two 1.38" (35mm) pendants
- Tubular boom backstops (telescopic type)
- Sheaves contain sealed anti-friction bearings
- Boom speed from 10°–70° is 65 seconds with no load. Speed was determined using 100' (30.5 m) of angle boom.

## Revolving Upper Structure

### ■ Frame

All welded steel frame with precision machined surfaces for mating parts.

### ■ Engine

Mitsubishi 6D24-TLA2E with oil filter, oil cooler, air cleaner, fuel filter, water separator, tachometer and electrical shutdown.

Number of cylinders	6
Bore and stroke – in. (mm)	5.12 x 5.91 (130 x 150)
Piston displacement – in <sup>3</sup> (cm <sup>3</sup> )	729 (11 945)
Engine rpm at full load speed	2,000
Hi-idle rpm	2,325
Full load speed – hp. (kw)	332 (248)
Peak torque – ft. lb. (joule)	746 (1 011)
Peak torque – rpm	1,400
Electrical system	24 volt

LS-308H II

Batteries	2–12 volt
Approximate fuel consumption	Gal./hr (L/hr)
100% H.P.	16 (60.56)
75% H.P.	12 (45.42)
50% H.P.	8 (30.28)
25% H.P.	4 (15.14)

### ■ Hydraulic System Specifications

**Hydraulic Pumps** – The pump arrangement is designed to provide hydraulically powered functions allowing positive, precise control with independent or simultaneous operation of all crane functions.

- Two variable displacement pumps operating at 4,554 psi (320 kg/cm<sup>2</sup>) and 83 gal/min (315L/min) powers load

hoist drum, boom hoist drum, optional third drum, and travel.

- One fixed displacement gear type pump operating at 3,000 psi (210kg/cm<sup>2</sup>) and 35 gal/min (132 L/min) powers the swing motors.
- One fixed displacement gear type pump operating at 3,600 psi (253 kg/cm<sup>2</sup>) and 31 gal/min (117 L/min) jack cylinders and swing motors.
- One fixed displacement gear type pump operating at 1,200 psi (84.4kg/cm<sup>2</sup>) and 10.5 gal/min (39.7L/min) remote control valves.



# PRELIMINARY

**Link-Belt**  
CONSTRUCTION EQUIPMENT

## Revolving Upper Structure – (continued)

**Pump Control (“Fine Inching”) mode** – Special pump setting, selectable from operator’s cab, that allows very slow movements of load hoist drums, boom hoist drum, and travel for precision work.

**Hydraulic Reservoir** – 79 gal (300L), equipped with sight level gauge. Diffusers built in for deaeration.

**Filtration** – One 10 micron, full flow, line filter in the control circuit. All oil is filtered prior to entering the reservoir.

**Counterbalance Valves** – All hoist motors are equipped with counterbalance valves to provide positive load lowering and prevent accidental load drop if the hydraulic pressure is suddenly lost.

**Optional Hydraulic Circuit** – Optional hydraulic power package for additional hydraulic supply for various attachments, controlled through a separate variable flow control valve eliminates pump cavitation and contamination.

System includes:

- Remote oil cooler
- Secondary hydraulic tank
- Pump control in operator’s cab
- Nephron filter
- Connection ports for hydraulic hammer or other tools.
- Three spotter circuits.

## ■ Load Hoist Drums

Each drum contains a pilot controlled, bi-directional, axial piston motor and a planetary gear reduction unit to provide positive control under all load conditions.

- Power up/down & free-fall operation modes
- Automatic brake mode (spring applied, hydraulically released, band type brake)
- 1.12” (28.4 mm) grooved lagging
- Drum pawl controlled manually
- Drum rotation indicators
- Mounted on anti-friction bearings
- 22” (0.56 m) root diameter
- 43.3” (1.10 m) flange diameter
- 27.1” (0.69 m) width

**Note:** The freefall operational mode is designed to prevent load lowering even if the freefall switch is accidentally activated. The automatic brake mode meets all OSHA requirements for personnel handling.

**Drum Clutches** – Speed-o-Matic™ power hydraulic two shoe clutch design that uses a 37” (940mm) diameter X 5.5” (139.7 mm) wide shoe that internally expands to provide load control. Swept area is 638 in<sup>2</sup> (4 116cm<sup>2</sup>).

## ■ Optional Front Mounted Third Hoist Drum

The hydraulic winch is pinned to the front of the upper frame and is used in conjunction with a fleeting sheave and 3-sheave idler assembly to run the wire rope over the boom top section.

- Free-spooling capability for pile driving applications
- 12.75” (0.32 m) root diameter
- 22.75” (0.58 m) flange diameter
- 17” (0.43 m) width
- Mounted on anti-friction bearings

## ■ Boom Hoist Drum

Contains a pilot controlled, bi-directional, axial piston motor and a planetary gear reduction unit to provide positive control under all load conditions.

- Spring applied, hydraulically released, disc type brake controlled automatically
- 3/4” (19 mm) grooved lagging
- Drum pawl controlled automatically
- Mounted on anti-friction bearings
- 19.84” (0.50 m) root diameter
- 33.86” (0.86 m) flange diameter
- 9.82” (0.25 m) width

## ■ Swing System

Pilot controlled bi-directional axial piston motors and the planetary gear reduction unit to provide positive control under all load conditions.

- Spring applied, hydraulically released, 360 degree multi-plate brake
- Free swing mode when lever is in neutral position
- Four position positive house lock
- Two-speed swing
- Audio/Visual swing alarm
- Maximum swing speed is 2.9 rpm

## ■ Counterweight

Removable, seven-piece design consisting of a base slab pinned in place with quick disconnect hydraulic cylinders and wing counterweights held in place with chain and ratchet tie-downs.

Two counterweight configuration options:

- “A” – 23,594 lbs. (10 702 kg) – (Base plus a left and right wing counterweights.
- “AB” – 50,496 lbs. (22 905 kg) – Base plus six wing counterweights (three left and three right).

### Counterweight components

- Base slab – 10,143 lbs. (4 601 kg)
- Left wing – 6,836 lbs. (3 101 kg) each
- Right wing – 6,615 lbs. (3 001 kg) each

## ■ Operator’s Cab and Controls

Fully enclosed modular steel compartment is independently mounted and insulated to protect against vibration and noise.

- All tinted/tempered safety glass
- Sliding entry door and front window
- Swing up roof window with wiper
- Door and window locks
- 19,000 BTU heater with circulating fan
- 18,650 BTU air conditioner
- Sun visor
- Engine instrumentation panel (voltmeter, engine oil pressure, engine water temperature, fuel level, hydraulic oil temperature, hour meter and service monitor system)
- Drum rotation indicators for front and rear hoist drums
- Six way adjustable seat
- Dry chemical fire extinguisher
- Hand and foot throttle
- Fully adjustable single axis arm chair controls

# PRELIMINARY



## LS-308H II Load Hoisting Performance

Available line speed and line pull – based on Mitsubishi 6D24-TEB at 2,000 rpm full load speed. Line pulls are not based on wire rope strength. See Wire Rope Capacity Chart for maximum permissible single part of line working loads.

Rope Layer	Front or Rear Drum – 1 1/8" (28.4 mm) Wire Rope											
	Maximum Line Pull		No Load Line Speed		Full Load Line Speed		Pitch Diameter		Layer		Total	
	lb	kg	ft/min	m/min	ft/min	m/min	in	mm	ft	m	ft	m
1	55,596	25 217	397	121	106	32	23.2	589	130.4	40	130	40
2	50,675	22 986	435	133	116	35	25.4	645	143.1	44	274	84
3	46,555	21 117	474	144	126	38	27.7	704	155.8	47	429	131
4	43,054	19 529	512	156	136	41	29.9	759	168.4	51	598	182
5	40,043	18 163	551	168	147	45	32.2	818	181.1	55	779	237
6	37,426	16 976	589	180	157	48	34.4	874	193.8	59	973	297
7	35,129	15 934	628	191	167	51	36.7	932	206.4	63	1,179	359
8	33,099	15 013	666	203	178	54	38.9	988	219.1	67	1,398	426

Rope Layer	Boom Hoist Drum – 3/4" (19 mm) Wire Rope											
	Maximum Line Pull		No Load Line Speed		Full Load Line Speed		Pitch Diameter		Layer		Total	
	lb	kg	ft/min	m/min	ft/min	m/min	in	mm	ft	m	ft	m
1	36,684	16 640	162	49.4	154	47	20.6	523	65	20	65	20
2	34,193	15 646	174	53	165	50	22.1	561	69	21	134	41
3	32,019	14 524	186	56.6	176	53	23.6	599	73	22	207	63
4	30,105	13 655	197	60.2	187	57	25.1	638	78	24	285	87
5	28,407	12 885	209	63.8	199	61	26.6	676	81	25	366	112
6	26,890	12 197	221	67.4	210	64	28.1	714	87	26	453	138
7	25,527	11 579	233	71	221	67	29.6	752	90	27	543	166
8	24,296	11 020	245	74.6	232	71	31.1	790	95	29	638	194

Rope Layer	Rear Mounted Fourth Drum – 7/8" (22.2 mm) Wire Rope											
	Maximum Line Pull		No Load Line Speed		Full Load Line Speed		Pitch Diameter		Layer		Total	
	lb	kg	ft/min	m/min	ft/min	m/min	in	mm	ft	m	ft	m
1	39,229	17 794	193	59	184	56	18.5	470	68	21	68	21
2	35,841	16 257	212	64.5	202	62	20.3	516	74	23	142	43
3	32,922	14 933	230	70.1	219	67	22.0	559	79	24	221	67
4	30,562	13 863	248	75.7	236	72	23.8	605	86	26	307	94
5	28,466	12 912	266	81.2	254	77	25.5	648	91	28	398	121
6	26,638	12 083	285	86.8	271	83	27.3	693	97	30	495	151
7	25,032	11 354	303	92.4	289	88	29.0	737	103	31	598	182
8	23,608	10 708	321	98	306	93	30.8	782	108	33	706	215

Rope Layer	Front Mounted Third Drum – 3/4" (19mm) Wire Rope											
	Maximum Line Pull		No Load Line Speed		Full Load Line Speed		Pitch Diameter		Layer		Total	
	lb	kg	ft/min	m/min	ft/min	m/min	in	mm	ft	m	ft	m
1	15,0159	6 811	189	57	212	64	13.5	343	72	22	72	22
2	13,513	6 129	210	64	236	72	15	381	80	24	153	46
3	12,285	5 572	231	70.4	260	79	16.5	419	88	27	242	74
4	11,261	5 108	252	76.8	283	86	18	457	96	29	339	103
5	10,395	4 715	273	83.2	307	94	19.5	495	104	32	444	135
6	9,652	4 378	294	89.6	331	101	21	533	113	34	557	170

Wire Rope Application	Diameter		Length		Type	Maximum Permissible Load	
	in	mm	ft	m		lbs	kg
Main Hoist	1 1/8	28.4	700	213	DB	37,100	16 828
Auxilliary Hoist	1 1/8	28.4	700	213	RB	28,600	12 973
Boom Hoist	3/4	19	465	142	W	16,800	7 620
Third Drum	3/4	19	600	183	DB	16,800	7 620

Rope Type	Description
DB	6 x 26 (6 X 19 Class) – Warrington Seale – Extra Improved Plow Steel – Preformed – Right Lay – Regular Lay – I.W.R.C.
RB	19 x 19 Rotation Resistant – Extra Improved Plow Steel – Preformed – Right Lay – Regular Lay – Swaged – SF=5.1
N	6 x 25 (6 x 19 Class) – filler wire, extra improved plow steel, preformed, independent wire rope center, right lay, alternate lay.
W	6 x 26 (6 x 19 Class) – extra improved plow steel, preformed, independent wire rope center, right lay, alternate lay



# PRELIMINARY

**Link-Belt**  
CONSTRUCTION EQUIPMENT

## ■ Operator's Cab and Controls *(continued)*

- Swing lever with swing brake and horn located on handle
- Bubble type level
- Ergonomic gauge layout
- Control shut off lever

## ■ Additional Equipment – Standard

- 71.02" (1.80m) outside diameter turntable bearing
- Right and Left side removable catwalks
- 132 US Gallon (500 L) fuel tank (usable quantity)
- Machine lifting links

## ■ Additional Equipment – Optional

- Rud-o-matic® model 648 tagline winder
- Full revolving type Fairleader with barrel, sheaves, and guide rollers.

## Lower Structure

### ■ Lower Frame

All welded box construction frame with precision-machined surfaces for turntable bearing and rotating joint.

- 10'-8" (3.25m) overall width
- 11'-11" (3.6m) overall length

### ■ Treadmembers

All welded, precision-machined, steel frames can be hydraulically extended and retracted by a hydraulic cylinder mounted in the lower frame.

- 14'-6" (4.42m) extended gauge
- 9' (2.74m) retracted gauge
- 20'-11" (6.37m) overall length
- 36" (0.9m) wide track shoes
- 11 sealed (oil filled) track rollers per treadmember
- Sealed (oil filled) idler and drive planetaries
- Compact travel drives
- Hydraulic adjusting tracks

**Travel and Steering** – Each treadmember contains a pilot controlled, bi-directional, axial piston motor and a planetary gear reduction unit to provide positive control under all load conditions.

- Individual control provides smooth, precise maneuverability including full counter-rotation.
- Spring applied, hydraulically released disc type brake controlled automatically.
- Maximum travel speed is 1.08 mph (1.45km/h).
- Designed to 30% gradeability.

### ■ Carbody Jacks

System contains four hydraulic cylinders individually mounted on swing out beams.

- Individual controls are mounted on carbody.
- Minimum height of carbody when resting on pontoons is 16" (0.41m).
- Maximum height of carbody when resting on pontoons is 42" (1.07m).

**PRELIMINARY**



**Link-Belt Construction Equipment Company**

Lexington, Kentucky

[www.linkbelt.com](http://www.linkbelt.com)

®Link-Belt is a registered trademark. Copyright 2001. We are constantly improving our products and therefore reserve the right to change designs and specifications.

LS-308H II

**PRELIMINARY**

# PRELIMINARY

**Link-Belt**  
CONSTRUCTION EQUIPMENT

# Lifting Capacities

Lattice Boom Crawler Crane

## LS-308H II

110-ton (99.79 metric ton)

### HYLAB Series

#### Angle Boom Capacities

50' – 160' (15.24 – 48.76 m)

#### Duty Cycle Capacities

- 50' – 120' (15.24 – 36.58 m) Angle Boom
- Extended Side Frames
- Dragline
- Clamshell / Magnet
- "AB" and "A" Counterweight Options

#### Angle Boom Capacities

- 50' – 160' (15.24 – 48.77 m) Angle Boom
- 25' (7.62 m) Open Throat Top Section
- Extended / Retracted Side Frames
- 360° Rotation Capacities
- Over End Blocked Capacities
- "AB", "A", and "0" Counterweight Options

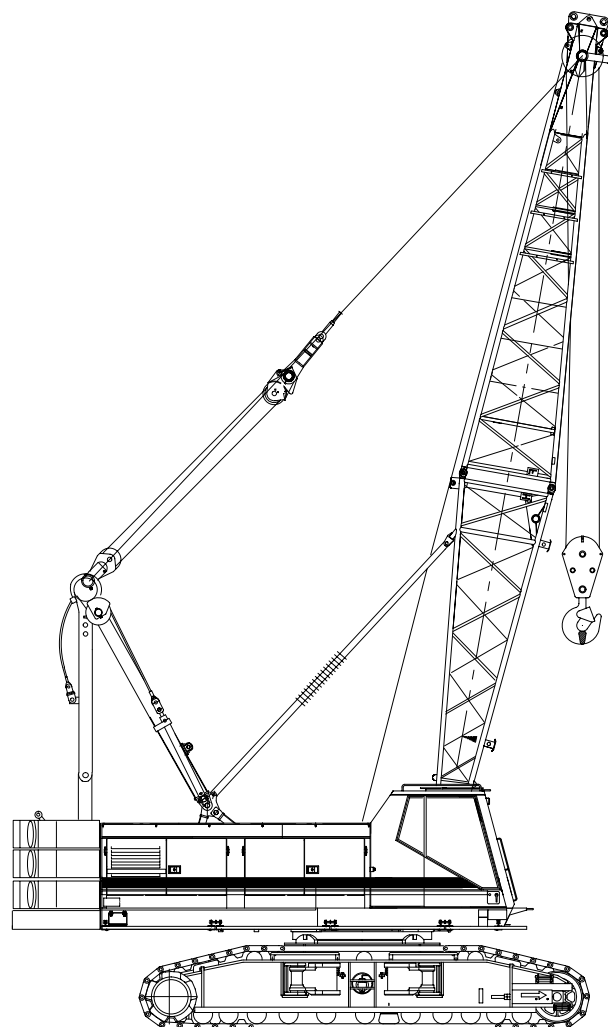

**CAUTION:** This material is supplied for reference use only. Operator must refer to in-cab Crane Rating Manual to determine allowable machine lifting capacities and operating procedures.





## WARNING

**READ AND UNDERSTAND THE OPERATOR'S AND SAFETY MANUALS AND THE FOLLOWING INSTRUCTIONS AND CHART VALUES BEFORE OPERATING THE CRANE. OPERATION WHICH DOES NOT FOLLOW THESE INSTRUCTIONS MAY RESULT IN AN ACCIDENT. THIS DOCUMENT IS INTENDED FOR REFERENCE USE ONLY.**

## OPERATING INSTRUCTIONS

### GENERAL:

1. Rated lifting capacities in pounds as shown on lift charts pertain to this crane as originally manufactured and normally equipped. Modifications to the crane or use of optional equipment other than that specified can result in a reduction of capacity.
2. Construction equipment can be dangerous if improperly operated or maintained. Operation and maintenance of this crane must be in compliance with the information in the Operator's, Parts, and Safety Manuals supplied with this crane. If these manuals are missing, order replacements through the distributor.
3. The operator and other personnel associated with this crane shall read and fully understand the latest applicable American National Standards Institute (ANSI) safety standards for cranes.
4. All capacities listed in this book are in compliance with ASME/ANSI B30.5c-1998, SAE J987-April 1994, and SAE J-765 October 1990.

### LIFT CRANE OPERATION:

1. Capacities shown are in pounds and are not more than 75% of the tipping loads with the crane standing level on firm supporting surface. A deduction must be made from these capacities for weight of hook block, hook ball, sling, grapple, etc. When using main hook while jib is attached, reduce capacities by values shown on Capacity Deductions For Lifting Off Main Boom Hook With Jib Installed. When using main hook while 5 foot tip extension or pile driver lead adapter is attached, reduce capacities by values shown on Capacity Deductions For Lifting Off Main Boom Hook With 5 Foot Tip Extension or Pile Driver Lead Adapter Installed. See Operator's Manual for all limitations when raising or lowering attachment.
2. The crane capacities in the shaded areas are based on structural strength. The crane capacities in the non-shaded areas are based on stability.
3. For recommended reeving, parts of line, wire rope type, and wire rope inspection, see Wire Rope Capacity Chart, Operator's Manual, and Parts Manual. Rated lifting capacities are based on correct reeving. Deduction must be made for excessive reeving. Any reeving over minimum required (see Wire Rope Capacity Chart) is considered excessive and must be accounted for when making lifts. Use Working Range Diagram to estimate the extra feet of rope. See Wire Rope Capacity for the weight to deduct for each extra foot of wire rope before attempting to lift a load.
4. Rated lifting capacities in this Crane Rating Manual are based on freely suspended loads and make no allowances for such factors as the effect of ground conditions and operating speeds. The operator shall therefore reduce load ratings in order to take these conditions into account.

5. Rated lifting capacities do not account for the effects of wind on a suspended load or boom. Lifting capacities should be considered acceptable for wind speeds less than 20 mph and appropriately reduced for wind speeds greater than 20 mph. (See General Wind Restrictions Guide.)
6. The capacities listed are for the crane equipped with or without live mast and with the gantry in the raised position.
7. The least stable rated condition is over the side.
8. Booms should be erected and lowered over the end for maximum stability. See Liff-off Capabilities before erecting or lowering boom.
9. Do not operate at radii and boom lengths where the Crane Rating Manual lists no capacity. Do not use longer booms or jibs than those listed in this Crane Rating Manual. Any of the above can cause a tipping condition, or boom and jib failure.
10. These capacities apply only to the crane as originally manufactured and normally equipped by Link-Belt Construction Equipment Company.

### FOR OVER END BLOCKED CAPACITIES ONLY:

1. These capacities can be lifted over either end with the crane standing level on a firm supporting surface with adequate blocking placed under the tread member sprockets/idlers, to prevent rocking.
2. Do not travel with a load.

### TRAVELING WITH A LOAD:

1. All 360° Rotation Capacities listed in this Crane Rating Manual are pick and carry capacities.
2. The boom must be pointing straight over one end of the crawler lower. If the load was lifted over the side, swing the load over the end and/or if the load was lifted at a long radius and the load is at or near capacity for that radius, boom up to obtain a greater lifting capacity before beginning travel.
3. Engage the swing lock and apply swing brake.
4. Travel slowly and cautiously on a firm and level-supporting surface.

### DEFINITIONS:

1. Load Radius: Horizontal distance from a projection of the axis of rotation to the supporting surface, before loading, to the center of the vertical hoist line or tackle with load applied.
2. Boom Angle: The angle between the boom base section and horizontal with freely suspended load at the rated radius.
3. Working Area: Area measured in a circular arc about the centerline of rotation as shown on the Working Area Diagram.
4. Freely Suspended Load: Load hanging free with no direct external force applied except by the hoist line.
5. Side Load: Horizontal side force applied to the lifted load either on the ground or in the air.



# PRELIMINARY



## WIRE ROPE CAPACITY

Parts of Line	1"			3/4"	7/8"	Notes
	Type "DB"	Type "RB"	Type "M"	Type "DB"	Type "DB"	
1	37,100	28,600	37,100	16,800	22,700	Capacities shown are in pounds and working loads must not exceed the ratings on the capacity charts in this Crane Rating Manual. Study Operator's Manual for wire rope inspection procedures.
2	74,200	57,200	—	33,600	45,400	
3	111,300	85,800	—	50,400	68,100	
4	148,400	114,400	—	67,200	90,800	
5	185,500	143,000	—	84,000	113,500	
6	222,600	171,600	—	100,800	136,200	
Rope weight per foot	2.34	2.50	2.23	1.04	2.34	
<b>LBCE Type</b>	<b>Description</b>					
DB	6 x 26 (6 x 19 Class) – Warrington Seale – Extra Improved Plow Steel – Preformed – Right Lay – Regular Lay – I.W.R.C.					
RB*	19 x 19 Rotation Resistant– Extra Extra Improved Plow Steel – Preformed – Right Lay – Regular Lay. Swaged – SF = 5:1					
M	6 x 25 (6 x 19 Class) – Filler Wire – Extra Improved PLow Steel – Preformed – Independent Wire Rope Center – Right Lay, Lang Lay					
* Use of swivel end with 1 part of line is not recommended.						
**Weight to be deducted from main capacities when using extra reeving.						

## LIFTOFF CAPABILITIES

Counterweight (Side Frames)	Over End (Gantry In Raised Position)	
	Maximum Boom (ft.)	Maximum Boom + Jib (ft.)
NO (RETRACTED)	80	N/A
NO (EXTENDED)	100	N/A
A (RETRACTED)	110	N/A
A (EXTENDED)	130	N/A
AB (EXTENDED)	160 (See Note 4)	140 + 75
Counterweight (Side Frames)	Over Side (Gantry In Raised Position)	
	Maximum Boom (ft.)	Maximum Boom + Jib (ft.)
NO (RETRACTED)	80	N/A
NO (EXTENDED)	100	N/A
A (RETRACTED)	110	N/A
A (EXTENDED)	130	N/A
AB (EXTENDED)	—	—

## WORKING AREAS

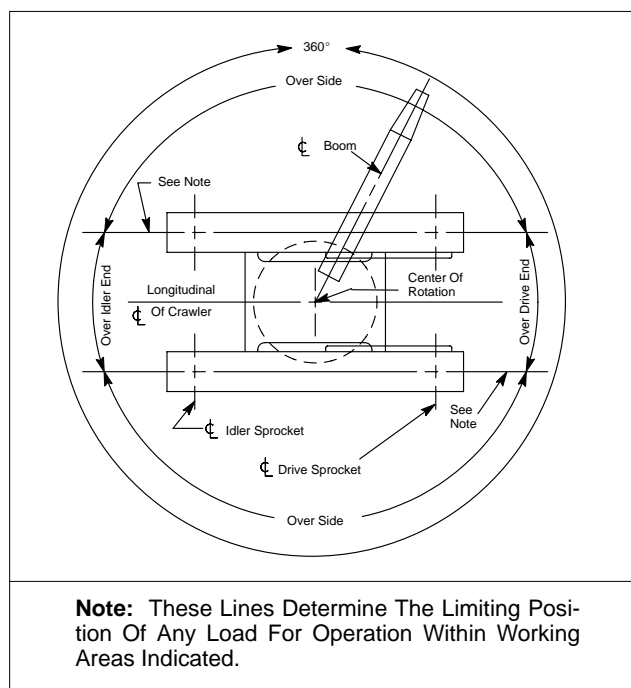

### NOTES:

1. For maximum boom and maximum boom + jib combinations only – adequate blocking must be placed under side frame sprockets/ idlers to prevent rocking. The ramps supplied with the crane are considered to be adequate blocking.
2. Crane on firm and level surface.
3. Gantry pins must be installed with the gantry in the raised position.
4. For maximum stability, booms must be erected and lowered over the end blocked with no load and with the hook block on the ground.

**GENERAL WIND RESTRICTIONS GUIDE**

**⚠ WARNING**

Failure to follow these wind speed restrictions may result in structural failure of the boom, which would cause property damage and/or bodily injury.

1. The effects of the wind force on the hook load are the responsibility of the user and are not taken into account. When hoisting any load in windy conditions, the load wind area and load controllability must be considered for safe crane operation.
2. Wind speed is to be determined at the boom top section.

**WIND SPEED CHART**

Boom Lengths: 40' to 250'	
DESCRIPTION	ALLOWABLE WINDSPEEDS
1. Normal Lifting Operation. (See Capacity Charts.)	0–20 m.p.h.
2. Reduced Operation. <b>Capacities must be reduced by 20%.</b>	21–30 m.p.h.
3. Reduced Operation. <b>Capacities must be reduced by 40%.</b>	31–40 m.p.h.
4. Reduced Operation. <b>Capacities must be reduced by 70%.</b>	41–45 m.p.h.
4. No Operation. <b>Store Attachment On Ground.</b>	Over 45 m.p.h.

**CRANE ASSEMBLY COMPONENT WEIGHTS**

Component	Weight	
	lbs.	kg
1. 25 Ft. Top Section With 3–Sheave Lift/Drag Head Machinery, with Basic Pendants	5,530	2 508
2. 25 Ft. Top Section With 3–Sheave Lift/Drag Head Machinery and 5 Ft. Tip Extension With Basic Pendants	6,195	2 809
3. 25 Ft. “Plate” Base Section With Lifting Sheaves 25 Ft. “Lattice” Base Section With Lifting Sheaves	5,528	2 507
	4,660	2 114
4. Boom Extensions		
• 10' Boom Extension With Pendants	1,596	724
• 20' Boom Extension With Pendants	2,638	1 196
• 30' Boom Extension With Pendants	3,613	1 638
5. Upper Counterweights		
• Counterweight “A”	23,594	10 702
• Counterweight “B”	26,902	12 203
6. Side Frames (Each)	23,561	10 687
7. Tube Jib Including Strut, Head Machinery, and Pendants		
• 30' Tube Jib Assembly	1,676	760
• 15' Extension With Pendants	319	145

# PRELIMINARY



## 50' TO 160' MAIN BOOM

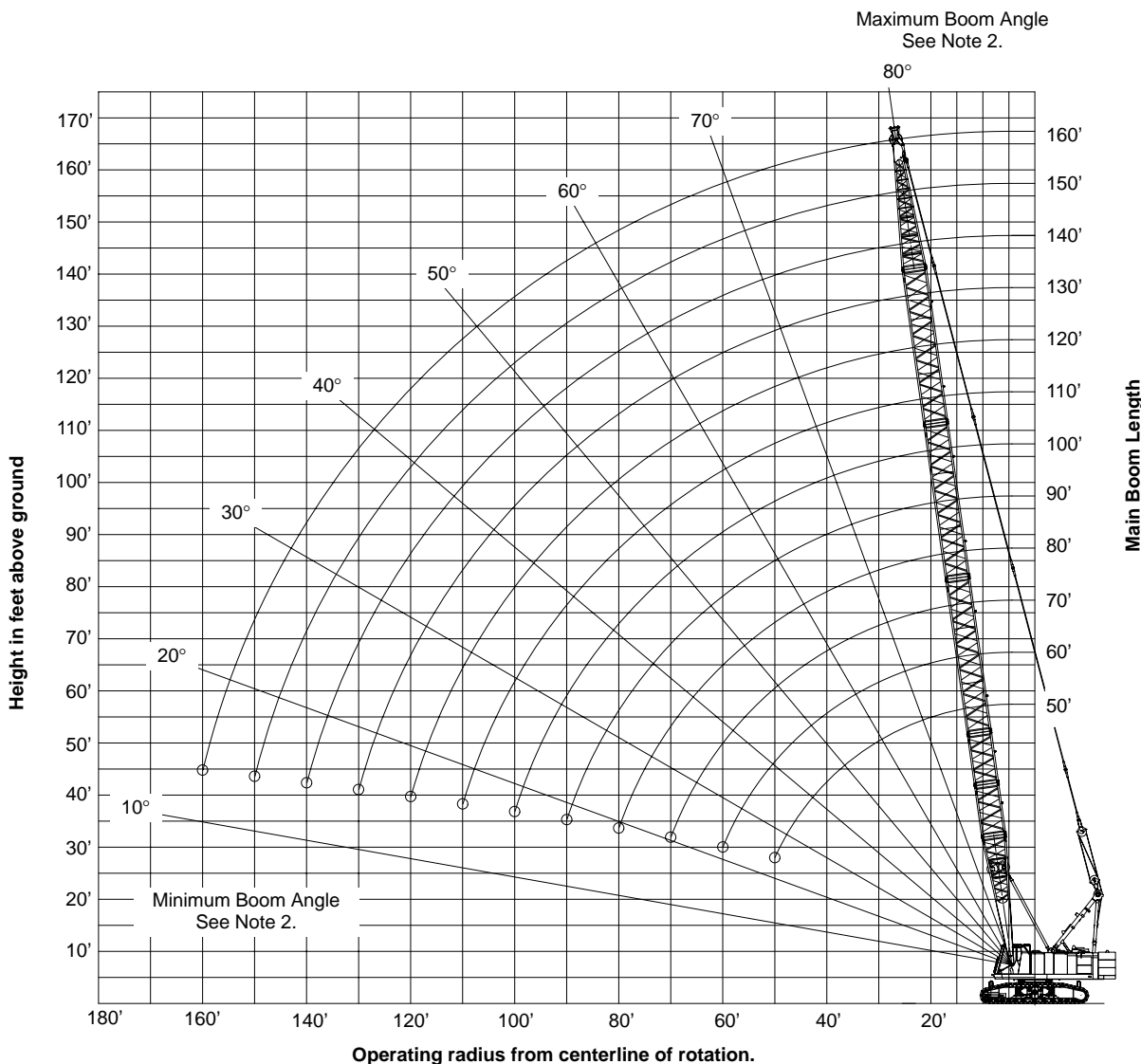

**Notes:**

- Boom geometry shown is for unloaded condition and crane standing level on firm supporting surface. Boom deflection, subsequent radius, and boom angle change must be accounted for when applying load to hook.
- Maximum and minimum boom angles are equal to the values listed in the capacity chart for each boom length.



**CAPACITY DEDUCTIONS FOR LIFTING OFF MAIN BOOM HOOK WITH JIB INSTALLED**

When using main boom hook, while jib is attached, reduce boom capacities by the values in the following chart:

Jib Length (ft.)	Capacity Deduction (lb)
30	2,100
45	2,800
60	3,500
75	4,400

**CAPACITY DEDUCTIONS FOR LIFTING OFF MAIN BOOM HOOK WITH 5 FOOT TIP EXTENSION OR PILE DRIVER LEAD ADAPTERS INSTALLED**

When using main boom hook, while 5 foot tip extension or pile driver lead adapter is attached, reduce boom capacities by the values in the following chart:

Extension/Adapter	Capacity Deduction (lb)
5 (01ft.)	700
Pile Driver Lead Adapter	200

**MAXIMUM ALLOWABLE CAPACITIES FOR 5 FOOT TIP EXTENSION**

LIFTING CAPACITY TO BE THE SMALLEST OF THE FOLLOWING VALUES:

- 18,000 lb (Maximum).
- The standard crane lift capacity minus 700 lb for the crane configuration in use.

**NOTES:**

- All notes are to be adhered to as listed on the standard lift crane capacity charts .
- Reduce the main boom lift capacities by 700 lb when the tip extension is installed.
- The maximum boom length on which the tip extension can be installed is 150 ft.
- Do not lift or suspend a load from the boom tip extension and main boom at the same time.

**MAXIMUM ALLOWABLE CAPACITIES FOR PILE DRIVER LEAD ADAPTER**

LIFTING CAPACITY TO BE THE SMALLEST OF THE FOLLOWING VALUES:

- 70,000 lbs.
- The standard crane lift capacity minus 200 lbs. for crane configuration in use.

**NOTES:**

- All notes are to be adhered to as listed on the standard lift crane capacity charts.
- Reduce the main boom lift capacities by 200 lb when the pile driver lead adapter is installed.
- The maximum boom length on which the pile driver lead adapter can be installed is 150 ft.

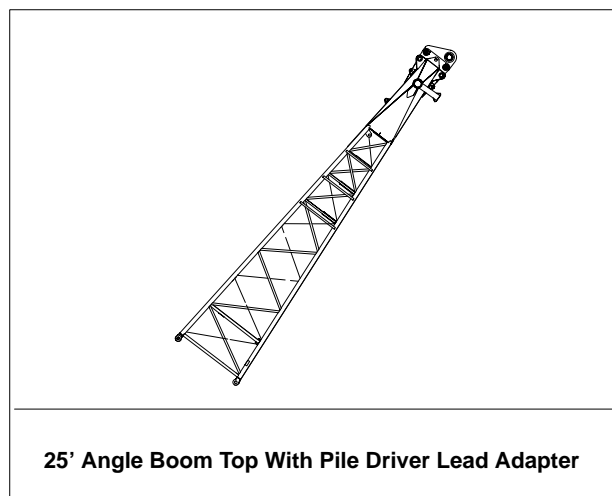

**25' Angle Boom Top With Pile Driver Lead Adapter**

**PRELIMINARY**

MAIN BOOM CAPACITIES - 50 FT OPEN THROAT ANGLE BOOM								
Load Radius (ft)	Boom Angle (deg)	Over End Blocked AB Cwt (lb)	360° Rotation					Load Radius (ft)
			Side Frames Extended			Side Frames Retracted		
			AB Cwt (lb)	A Cwt (lb)	0 Cwt (lb)	A Cwt (lb)	0 Cwt (lb)	
11.4	82.0	220,000	220,000	189,700	170,700	128,200	78,600	11.4
12	81.3	201,100	201,100	180,800	162,600	117,000	71,600	12
13	80.1	186,700	186,700	167,800	136,900	102,400	62,500	13
14	79.0	174,200	174,200	156,500	115,500	90,900	55,300	14
15	77.8	163,300	163,300	146,600	99,700	81,600	49,500	15
16	76.6	153,600	153,600	131,700	87,600	74,000	44,700	16
17	75.4	144,900	144,900	117,500	78,000	67,600	40,700	17
18	74.2	137,100	137,100	106,000	70,200	62,200	37,300	18
19	73.1	130,100	130,100	96,500	63,800	57,500	34,300	19
20	71.9	123,800	122,400	88,500	58,400	53,400	31,800	20
25	65.7	99,300	86,300	62,000	40,500	39,100	22,800	25
30	59.2	80,000	66,200	47,300	30,500	30,500	17,400	30
35	52.3	63,800	53,400	37,900	24,100	24,700	13,700	35
40	44.6	52,800	44,500	31,300	19,700	20,500	11,100	40
50	24.3	38,800	32,900	22,800	13,900	14,900	7,600	50

MAIN BOOM CAPACITIES - 60 FT OPEN THROAT ANGLE BOOM								
Load Radius (ft)	Boom Angle (deg)	Over End Blocked AB Cwt (lb)	360° Rotation					Load Radius (ft)
			Side Frames Extended			Side Frames Retracted		
			AB Cwt (lb)	A Cwt (lb)	0 Cwt (lb)	A Cwt (lb)	0 Cwt (lb)	
12.78	82.0	188,600	188,600	169,500	142,800	105,000	64,000	12.78
13	81.8	185,600	185,600	166,800	136,900	102,000	62,100	13
14	80.8	173,200	173,200	155,600	115,500	90,500	54,900	14
15	79.8	162,300	162,300	145,700	99,600	81,300	49,100	15
16	78.9	152,600	152,600	131,500	87,500	73,600	44,300	16
17	77.9	144,000	144,000	117,300	77,900	67,200	40,300	17
18	76.9	136,300	136,300	105,800	70,000	61,800	36,900	18
19	75.9	129,300	129,300	96,300	63,600	57,100	33,900	19
20	75.0	123,000	122,200	88,200	58,100	53,000	31,400	20
25	69.9	98,600	86,000	61,700	40,200	38,700	22,400	25
30	64.8	79,700	65,900	46,900	30,100	30,000	16,900	30
35	59.4	63,400	53,000	37,500	23,700	24,200	13,300	35
40	53.6	52,400	44,100	30,900	19,300	20,100	10,700	40
50	40.6	38,400	32,500	22,400	13,500	14,500	7,100	50
60	22.1	29,800	25,300	17,200	9,900	10,900	4,900	60

MAIN BOOM CAPACITIES - 70 FT OPEN THROAT ANGLE BOOM								
Load Radius (ft)	Boom Angle (deg)	Over End Blocked AB Cwt (lb)	360° Rotation					Load Radius (ft)
			Side Frames Extended			Side Frames Retracted		
			AB Cwt (lb)	A Cwt (lb)	0 Cwt (lb)	A Cwt (lb)	0 Cwt (lb)	
14.17	82.0	170,200	170,200	152,800	112,400	88,500	53,500	14.17
15	81.3	161,300	161,300	144,800	99,500	80,900	48,700	15
16	80.5	151,700	151,700	131,400	87,300	73,200	43,900	16
17	79.7	143,100	143,100	117,100	77,600	66,800	39,900	17
18	78.8	135,500	135,500	105,600	69,800	61,400	36,500	18
19	78.0	128,500	128,500	96,000	63,300	56,700	33,500	19
20	77.1	122,200	121,900	87,900	57,800	52,600	31,000	20
25	72.9	97,900	85,700	61,400	39,800	38,300	21,900	25
30	68.6	79,300	65,500	46,500	29,800	29,600	16,500	30
35	64.1	63,100	52,600	37,100	23,300	23,800	12,800	35
40	59.5	52,000	43,700	30,500	18,900	19,600	10,200	40
50	49.4	38,000	32,100	22,000	13,100	14,000	6,700	50
60	37.4	29,400	24,900	16,700	9,500	10,400	4,400	60
70	20.5	23,600	19,900	13,100	7,000	7,900	2,800	70

**PRELIMINARY**



**PRELIMINARY**

MAIN BOOM CAPACITIES - 80 FT OPEN THROAT ANGLE BOOM								
Load Radius (ft)	Boom Angle (deg)	Over End Blocked AB Cwt (lb)	360° Rotation					Load Radius (ft)
			Side Frames Extended			Side Frames Retracted		
			AB Cwt (lb)	A Cwt (lb)	0 Cwt (lb)	A Cwt (lb)	0 Cwt (lb)	
15.56	82.0	154,900	154,900	138,700	92,200	76,100	45,600	15.56
16	81.7	150,800	150,800	131,300	87,200	72,900	43,600	16
17	81.0	142,300	142,300	117,000	77,500	66,500	39,600	17
18	80.2	134,700	134,700	105,400	69,600	61,100	36,100	18
19	79.5	127,800	127,800	95,800	63,100	56,400	33,200	19
20	78.8	121,500	121,700	87,700	57,600	52,300	30,600	20
25	75.1	97,300	85,400	61,100	39,600	37,900	21,600	25
30	71.4	79,100	65,200	46,300	29,500	29,200	16,100	30
35	67.5	62,800	52,300	36,800	23,000	23,400	12,500	35
40	63.6	51,700	43,300	30,200	18,600	19,200	9,800	40
50	55.3	37,700	31,700	21,700	12,800	13,600	6,300	50
60	46.0	29,100	24,500	16,400	9,200	10,000	4,000	60
70	34.9	23,300	19,600	12,800	6,700	7,500	2,500	70
80	19.1	19,200	16,000	10,100	4,900	5,700	-----	80

MAIN BOOM CAPACITIES - 90 FT OPEN THROAT ANGLE BOOM								
Load Radius (ft)	Boom Angle (deg)	Over End Blocked AB Cwt (lb)	360° Rotation					Load Radius (ft)
			Side Frames Extended			Side Frames Retracted		
			AB Cwt (lb)	A Cwt (lb)	0 Cwt (lb)	A Cwt (lb)	0 Cwt (lb)	
16.95	82.0	141,900	141,900	117,500	77,800	66,500		16.95
18	81.3	133,900	133,900	105,200	69,500	60,700		18
19	80.7	127,100	127,100	95,600	62,900	56,100		19
20	80.0	120,800	120,800	87,500	57,400	52,000		20
25	76.8	96,700	85,200	60,900	39,300	37,600		25
30	73.5	78,900	64,900	46,000	29,200	28,900		30
35	70.1	62,500	52,000	36,500	22,700	23,000		35
40	66.7	51,400	43,000	29,900	18,200	18,900		40
50	59.6	37,300	31,400	21,300	12,400	13,200		50
60	51.9	28,800	24,200	16,000	8,800	9,700		60
70	43.2	23,000	19,300	12,400	6,300	7,200		70
80	32.9	18,800	15,700	9,800	4,600	5,300		80
90	18.0	15,700	13,000	7,800	3,200	3,900		90

MAIN BOOM CAPACITIES - 100 FT OPEN THROAT ANGLE BOOM								
Load Radius (ft)	Boom Angle (deg)	Over End Blocked AB Cwt (lb)	360° Rotation					Load Radius (ft)
			Side Frames Extended			Side Frames Retracted		
			AB Cwt (lb)	A Cwt (lb)	0 Cwt (lb)	A Cwt (lb)	0 Cwt (lb)	
18.34	82.0	130,700	130,700	101,500	66,900	58,700		18.34
19	81.6	126,300	126,300	95,400	62,700	55,700		19
20	81.0	120,100	120,100	87,300	57,200	51,600		20
25	78.1	96,100	84,900	60,600	39,000	37,200		25
30	75.2	78,600	64,600	45,700	28,900	28,500		30
35	72.2	62,200	51,600	36,100	22,400	22,700		35
40	69.2	51,100	42,700	29,500	17,900	18,500		40
50	62.9	37,000	31,000	21,000	12,100	12,900		50
60	56.2	28,400	23,800	15,700	8,400	9,300		60
70	49.0	22,600	18,900	12,000	6,000	6,800		70
80	40.9	18,400	15,300	9,400	4,200	4,900		80
90	31.2	15,300	12,600	7,400	2,800	3,500		90
100	17.1	12,800	10,500	5,800	-----	2,400		100

**PRELIMINARY**



**PRELIMINARY**

MAIN BOOM CAPACITIES - 110 FT OPEN THROAT ANGLE BOOM								
Load Radius (ft)	Boom Angle (deg)	Over End Blocked AB Cwt (lb)	360° Rotation					Load Radius (ft)
			Side Frames Extended			Side Frames Retracted		
			AB Cwt (lb)	A Cwt (lb)	0 Cwt (lb)	A Cwt (lb)	0 Cwt (lb)	
19.74	82.0	120,900	120,900	89,100		52,300		19.74
20	81.9	119,300	119,300	87,100		51,300		20
25	79.2	95,500	84,600	60,300		36,800		25
30	76.6	78,300	64,300	45,300		28,100		30
35	73.9	61,900	51,300	35,800		22,300		35
40	71.1	50,800	42,300	29,200		18,100		40
50	65.5	36,700	30,700	20,600		12,500		50
60	59.7	28,000	23,400	15,300		8,900		60
70	53.4	22,200	18,500	11,700		6,400		70
80	46.6	18,100	14,900	9,000		4,500		80
90	38.9	14,900	12,200	7,000		3,100		90
100	29.7	12,500	10,100	5,400		2,000		100
110	16.3	10,500	8,300	4,200		-----		110

MAIN BOOM CAPACITIES - 120 FT OPEN THROAT ANGLE BOOM								
Load Radius (ft)	Boom Angle (deg)	Over End Blocked AB Cwt (lb)	360° Rotation					Load Radius (ft)
			Side Frames Extended			Side Frames Retracted		
			AB Cwt (lb)	A Cwt (lb)	0 Cwt (lb)	A Cwt (lb)	0 Cwt (lb)	
21.13	82.0	112,300	110,200	79,100				21.13
25	80.1	94,800	84,300	60,000				25
30	77.7	78,000	63,900	45,000				30
35	75.2	61,600	51,000	35,500				35
40	72.8	50,500	42,000	28,800				40
50	67.7	36,300	30,300	20,200				50
60	62.4	27,700	23,000	14,900				60
70	56.9	21,900	18,100	11,300				70
80	51.0	17,700	14,500	8,600				80
90	44.5	14,500	11,800	6,600				90
100	37.2	12,100	9,700	5,100				100
110	28.4	10,100	8,000	3,800				110
120	15.6	8,400	6,500	2,700				120

MAIN BOOM CAPACITIES - 130 FT OPEN THROAT ANGLE BOOM								
Load Radius (ft)	Boom Angle (deg)	Over End Blocked AB Cwt (lb)	360° Rotation					Load Radius (ft)
			Side Frames Extended			Side Frames Retracted		
			AB Cwt (lb)	A Cwt (lb)	0 Cwt (lb)	A Cwt (lb)	0 Cwt (lb)	
22.52	82.0	104,700	99,100	70,800				22.52
25	80.9	94,100	84,000	59,700				25
30	78.7	77,700	63,600	44,700				30
35	76.4	61,300	50,600	35,100				35
40	74.1	50,100	41,600	28,500				40
50	69.5	35,900	29,900	19,900				50
60	64.7	27,300	22,700	14,500				60
70	59.7	21,500	17,700	10,900				70
80	54.5	17,300	14,100	8,200				80
90	48.8	14,100	11,400	6,200				90
100	42.7	11,700	9,300	4,600				100
110	35.7	9,700	7,500	3,400				110
120	27.2	8,100	6,100	2,300				120
130	15.0	6,700	4,900	-----				130

**PRELIMINARY**



**PRELIMINARY**

MAIN BOOM CAPACITIES - 140 FT OPEN THROAT ANGLE BOOM								
Load Radius (ft)	Boom Angle (deg)	Over End Blocked AB Cwt (lb)	360° Rotation					Load Radius (ft)
			Side Frames Extended			Side Frames Retracted		
			AB Cwt (lb)	A Cwt (lb)	0 Cwt (lb)	A Cwt (lb)	0 Cwt (lb)	
23.91	82.0	97,800	89,800					23.91
25	81.5	93,500	83,700					25
30	79.5	77,400	63,300					30
35	77.4	61,000	50,300					35
40	75.3	49,800	41,200					40
50	71.0	35,600	29,500					50
60	66.6	26,900	22,300					60
70	62.1	21,100	17,300					70
80	57.3	16,900	13,700					80
90	52.3	13,700	11,000					90
100	46.9	11,300	8,900					100
110	41.1	9,300	7,100					110
120	34.4	7,600	5,700					120
130	26.2	6,300	4,500					130
140	14.4	5,100	3,500					140

MAIN BOOM CAPACITIES - 150 FT OPEN THROAT ANGLE BOOM								
Load Radius (ft)	Boom Angle (deg)	Over End Blocked AB Cwt (lb)	360° Rotation					Load Radius (ft)
			Side Frames Extended			Side Frames Retracted		
			AB Cwt (lb)	A Cwt (lb)	0 Cwt (lb)	A Cwt (lb)	0 Cwt (lb)	
25.3	82.0	91,800	81,800					25.3
30	80.2	76,600	62,900					30
35	78.2	60,600	49,900					35
40	76.3	49,400	40,900					40
50	72.3	35,200	29,100					50
60	68.3	26,500	21,900					60
70	64.1	20,700	16,900					70
80	59.7	16,500	13,300					80
90	55.2	13,300	10,600					90
100	50.4	10,900	8,400					100
110	45.3	8,900	6,700					110
120	39.6	7,200	5,300					120
130	33.2	5,900	4,100					130
140	25.3	4,700	3,100					140
150	14.0	3,700	2,200					150

MAIN BOOM CAPACITIES - 160 FT OPEN THROAT ANGLE BOOM								
Load Radius (ft)	Boom Angle (deg)	Over End Blocked AB Cwt (lb)	360° Rotation					Load Radius (ft)
			Side Frames Extended			Side Frames Retracted		
			AB Cwt (lb)	A Cwt (lb)	0 Cwt (lb)	A Cwt (lb)	0 Cwt (lb)	
26.69	82.0	84,300	75,000					26.69
30	80.8	76,000	62,600					30
35	79.0	60,300	49,500					35
40	77.2	49,100	40,500					40
50	73.5	34,800	28,700					50
60	69.7	26,200	21,500					60
70	65.8	20,300	16,500					70
80	61.8	16,100	12,900					80
90	57.7	12,900	10,200					90
100	53.3	10,500	8,000					100
110	48.7	8,500	6,300					110
120	43.8	6,800	4,900					120
130	38.3	5,500	3,700					130
140	32.1	4,300	2,700					140
150	24.5	3,300	-----					150
160	13.5	2,400	-----					160

**PRELIMINARY**



**PRELIMINARY**

DUTY CYCLE CAPACITIES - 50 FT OPEN THROAT ANGLE BOOM						
Load Radius (ft)	Boom Angle (deg)	AB Ctw - 360° Rotation		A Ctw - 360° Rotation		Load Radius (ft)
		Side Frames Extended		Side Frames Extended		
		Dragline (lb)	Clam / Magnet (lb)	Dragline (lb)	Clam / Magnet (lb)	
11.4	82.0	---	32,250	---	32,250	11.4
12	81.3	---	32,250	---	32,250	12
13	80.1	---	32,250	---	32,250	13
14	79.0	---	32,250	---	32,250	14
15	77.8	---	32,250	---	32,250	15
16	76.6	---	32,250	---	32,250	16
17	75.4	---	32,250	---	32,250	17
18	74.2	---	32,250	---	32,250	18
19	73.1	---	32,250	---	32,250	19
20	71.9	---	32,250	---	32,250	20
25	65.7	---	32,250	---	32,250	25
30	59.2	32,250	32,250	32,250	32,250	30
35	52.3	32,250	32,250	32,250	32,250	35
40	44.6	32,250	32,250	31,300	28,100	40
50	24.3	---	29,600	---	20,500	50

DUTY CYCLE CAPACITIES - 60 FT OPEN THROAT ANGLE BOOM						
Load Radius (ft)	Boom Angle (deg)	AB Ctw - 360° Rotation		A Ctw - 360° Rotation		Load Radius (ft)
		Side Frames Extended		Side Frames Extended		
		Dragline (lb)	Clam / Magnet (lb)	Dragline (lb)	Clam / Magnet (lb)	
12.8	82.0	---	32,250	---	32,250	12.8
13	81.8	---	32,250	---	32,250	13
14	80.8	---	32,250	---	32,250	14
15	79.8	---	32,250	---	32,250	15
16	78.9	---	32,250	---	32,250	16
17	77.9	---	32,250	---	32,250	17
18	76.9	---	32,250	---	32,250	18
19	75.9	---	32,250	---	32,250	19
20	75.0	---	32,250	---	32,250	20
25	69.9	---	32,250	---	32,250	25
30	64.8	---	32,250	---	32,250	30
35	59.4	32,250	32,250	32,250	32,250	35
40	53.6	32,250	32,250	30,900	27,800	40
50	40.6	32,500	29,200	22,400	20,100	50
60	22.1	---	22,700	---	15,400	60

DUTY CYCLE CAPACITIES - 70 FT OPEN THROAT ANGLE BOOM						
Load Radius (ft)	Boom Angle (deg)	AB Ctw - 360° Rotation		A Ctw - 360° Rotation		Load Radius (ft)
		Side Frames Extended		Side Frames Extended		
		Dragline (lb)	Clam / Magnet (lb)	Dragline (lb)	Clam / Magnet (lb)	
14.2	82.0	---	32,250	---	32,250	14.2
15	81.3	---	32,250	---	32,250	15
16	80.5	---	32,250	---	32,250	16
17	79.7	---	32,250	---	32,250	17
18	78.8	---	32,250	---	32,250	18
19	78.0	---	32,250	---	32,250	19
20	77.1	---	32,250	---	32,250	20
25	72.9	---	32,250	---	32,250	25
30	68.6	---	32,250	---	32,250	30
35	64.1	---	32,250	---	32,250	35
40	59.5	32,250	32,250	30,500	27,400	40
50	49.4	32,100	28,800	22,000	19,800	50
60	37.4	24,900	22,400	16,700	15,000	60
70	20.5	---	17,900	---	11,700	70

**PRELIMINARY**



**PRELIMINARY**

DUTY CYCLE CAPACITIES - 80 FT OPEN THROAT ANGLE BOOM						
Load Radius (ft)	Boom Angle (deg)	AB Cwt - 360° Rotation		A Cwt - 360° Rotation		Load Radius (ft)
		Side Frames Extended		Side Frames Extended		
		Dragline (lb)	Clam / Magnet (lb)	Dragline (lb)	Clam / Magnet (lb)	
15.6	82.0	---	32,250	---	32,250	15.6
16	81.7	---	32,250	---	32,250	16
17	81.0	---	32,250	---	32,250	17
18	80.2	---	32,250	---	32,250	18
19	79.5	---	32,250	---	32,250	19
20	78.8	---	32,250	---	32,250	20
25	75.1	---	32,250	---	32,250	25
30	71.4	---	32,250	---	32,250	30
35	67.5	---	32,250	---	32,250	35
40	63.6	---	32,250	---	27,100	40
50	55.3	31,700	28,500	21,700	19,500	50
60	46.0	24,500	22,000	16,400	14,700	60
70	34.9	19,600	17,600	12,800	11,500	70
80	19.1	---	14,400	---	9,000	80

DUTY CYCLE CAPACITIES - 90 FT OPEN THROAT ANGLE BOOM						
Load Radius (ft)	Boom Angle (deg)	AB Cwt - 360° Rotation		A Cwt - 360° Rotation		Load Radius (ft)
		Side Frames Extended		Side Frames Extended		
		Dragline (lb)	Clam / Magnet (lb)	Dragline (lb)	Clam / Magnet (lb)	
17	82.0	---	32,250	---	32,250	17
18	81.3	---	32,250	---	32,250	18
19	80.7	---	32,250	---	32,250	19
20	80.0	---	32,250	---	32,250	20
25	76.8	---	32,250	---	32,250	25
30	73.5	---	32,250	---	32,250	30
35	70.1	---	32,250	---	32,250	35
40	66.7	---	32,250	---	26,900	40
50	59.6	31,400	28,200	21,300	19,100	50
60	51.9	24,200	21,700	16,000	14,400	60
70	43.2	19,300	17,300	12,400	11,100	70
80	32.9	---	14,100	---	8,800	80
90	18.0	---	11,700	---	7,000	90

DUTY CYCLE CAPACITIES - 100 FT OPEN THROAT ANGLE BOOM						
Load Radius (ft)	Boom Angle (deg)	AB Cwt - 360° Rotation		A Cwt - 360° Rotation		Load Radius (ft)
		Side Frames Extended		Side Frames Extended		
		Dragline (lb)	Clam / Magnet (lb)	Dragline (lb)	Clam / Magnet (lb)	
18.3	82.0	---	32,250	---	32,250	18.3
19	81.6	---	32,250	---	32,250	19
20	81.0	---	32,250	---	32,250	20
25	78.1	---	32,250	---	32,250	25
30	75.2	---	32,250	---	32,250	30
35	72.2	---	32,250	---	32,250	35
40	69.2	---	32,250	---	26,500	40
50	62.9	---	27,900	---	18,900	50
60	56.2	23,800	21,400	15,700	14,100	60
70	49.0	18,900	17,000	12,000	10,800	70
80	40.9	15,300	13,700	9,400	8,400	80
90	31.2	---	11,300	---	6,600	90
100	17.1	---	9,400	---	5,200	100

**PRELIMINARY**



**PRELIMINARY**

DUTY CYCLE CAPACITIES - 110 FT OPEN THROAT ANGLE BOOM						
Load Radius (ft)	Boom Angle (deg)	AB Ctw - 360° Rotation		A Ctw - 360° Rotation		Load Radius (ft)
		Side Frames Extended		Side Frames Extended		
		Dragline (lb)	Clam / Magnet (lb)	Dragline (lb)	Clam / Magnet (lb)	
19.7	82.0	---	32,250	---	32,250	19.7
20	81.9	---	32,250	---	32,250	20
25	79.2	---	32,250	---	32,250	25
30	76.6	---	32,250	---	32,250	30
35	73.9	---	32,250	---	32,250	35
40	71.1	---	32,250	---	26,200	40
50	65.5	---	27,600	---	18,500	50
60	59.7	23,400	21,000	15,300	13,700	60
70	53.4	18,500	16,600	11,700	10,500	70
80	46.6	14,900	13,400	9,000	8,100	80
90	38.9	12,200	10,900	7,000	6,300	90
100	29.7	---	9,000	---	4,800	100
110	16.3	---	7,400	---	3,700	110

DUTY CYCLE CAPACITIES - 120 FT OPEN THROAT ANGLE BOOM						
Load Radius (ft)	Boom Angle (deg)	AB Ctw - 360° Rotation		A Ctw - 360° Rotation		Load Radius (ft)
		Side Frames Extended		Side Frames Extended		
		Dragline (lb)	Clam / Magnet (lb)	Dragline (lb)	Clam / Magnet (lb)	
21.1	82.0	---	32,250	---	32,250	21.1
25	80.1	---	32,250	---	32,250	25
30	77.7	---	32,250	---	32,250	30
35	75.2	---	32,250	---	32,250	35
40	72.8	---	32,250	---	25,900	40
50	67.7	---	27,200	---	18,100	50
60	62.4	---	20,700	---	13,400	60
70	56.9	18,100	16,200	11,300	10,100	70
80	51.0	14,500	13,000	8,600	7,700	80
90	44.5	11,800	10,600	6,600	5,900	90
100	37.2	9,700	8,700	5,100	4,500	100
110	28.4	---	7,200	---	3,400	110
120	15.6	---	5,800	---	2,400	120

**PRELIMINARY**



# PRELIMINARY

---

**Link-Belt**  
CONSTRUCTION EQUIPMENT

**This page intentionally left blank**



**This page intentionally left blank**



# PRELIMINARY

---

**Link-Belt**  
CONSTRUCTION EQUIPMENT**Link-Belt Construction Equipment Company**

Lexington, Kentucky

[www.linkbelt.com](http://www.linkbelt.com)

© Link-Belt is a registered trademark. Copyright 2001. All rights reserved. We are constantly improving our products and therefore reserve the right to change designs and specifications.

