

model 111

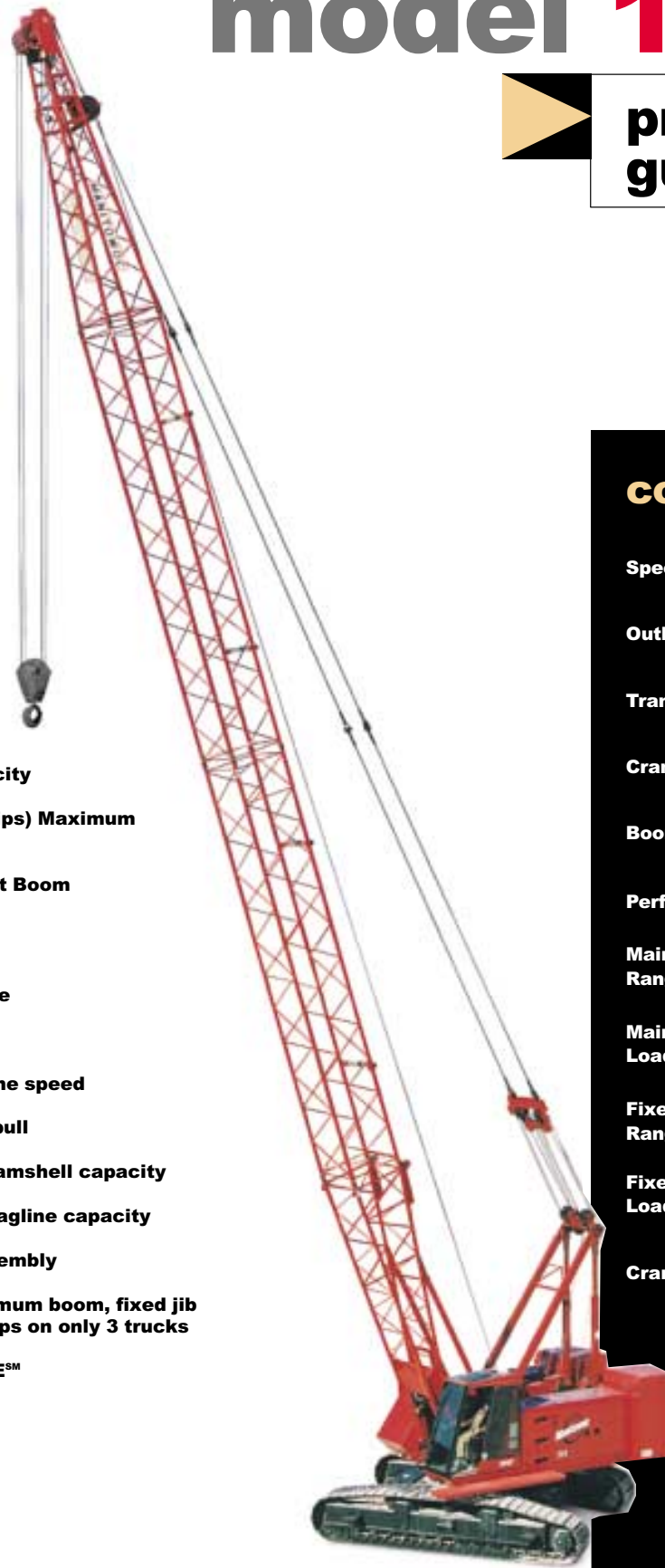

product guide

data



features

- 73 mton (80 ton) capacity
- 291 mton-m (2,100 ft-kips) Maximum Load Moment
- 57,9 m (190') Heavy-Lift Boom
- 70,1m (230') Fixed Jib on Heavy-Lift Boom
- 153 kW (205 HP) engine
- EPIC® controls
- 182 m/min (570 fpm) line speed
- 89 kN (20,000 lb) line pull
- 7 938 kg (17,500 lb) Clamshell capacity
- 7 938 kg (17,500 lb) Dragline capacity
- Fast, efficient self-assembly
- Complete crane, maximum boom, fixed jib and counterweight ships on only 3 trucks
- Manitowoc CraneCARESM

contents

Specifications	2
Outline Dimensions	5
Transport Data	9
Crane Assembly	10
Boom Combinations	11
Performance Data	12
Main Boom Range Diagram	14
Main Boom Load Charts	15
Fixed Jib Range Diagram	16
Fixed Jib Load Charts	17
CraneCARE SM	21



specifications

Upperworks

2



Engine

Cummins 6CT8.3 diesel, 6 cylinder, 153 kW (205 BHP) @ 2200 governed RPM. Manually operated disconnect clutch for cold weather starting. Multiple hydraulic pump drive transmission provides independent power for all machine functions.

Optional: consult factory for other available engines.

One 340 l (90 gal) capacity diesel fuel tank, mounted on rear of upperworks, with level indicator in operator's cab.

Two 12 volt maintenance-free, Group 8D batteries, 1155 CCA at -18°C (0° F), 12 volt starting and 130 amp alternator.



Controls

Modulating electronic-over-hydraulic controls provide infinite speed response directly proportional to control lever movement. Controls include Manitowoc's exclusive EPIC® *Electronic Processed Independent Controls* system providing microprocessor driven control logic, pump control, on-board diagnostics, and service information.

Block-up limit control is standard for hoist and whip lines.

Integrated Load Moment Indicator system (LMI) is standard for main boom, upper boom point, and fixed jib. "Function cut-out" or "warning only" operation is available via a keyed switch on the LMI console.

Optional travel and swing alarms are available.



Hydraulic System

Six high-pressure piston pumps are driven through a multi-hydraulic pump transmission. These six pumps provide independent "closed loop" hydraulic power for front drum, rear drum, boom hoist system, swing system, and both left and right crawler operation.

System	kg/cm ² (psi)	lpm (gpm)
Front Drum	422 (6,000)	284 (75)
Rear Drum	422 (6,000)	284 (75)
Boom Hoist	422 (6,000)	155 (41)
Swing System	316 (4,500)	155 (41)
Left Crawler	387 (5,500)	155 (41)
Right Crawler	387 (5,500)	155 (41)

Hydraulic reservoir capacity is 568 l (150 gal) and is equipped with breather, dipstick, clean out access, and internal diffuser.

Each function is equipped with relief valves to protect the hydraulic circuit from overload or shock.

Replaceable, spin on ten micron (absolute) full flow line filter is furnished in the hydraulic circuit. All oil is filtered prior to return to the hydraulic reservoir.

Hydraulic system also includes pump transmission disconnect clutch & hydraulic oil cooler.



Drums

Two identical winches 483 mm(19") diameter and 543 mm (21-3/8") wide are driven by independent variable displacement axial piston hydraulic motors through planetary reduction mounted on separate front and rear shafts with anti-friction bearings.

Powered lowering standard with automatic (spring applied, hydraulically released) multi-disc brakes and drum rotation indicators.

Optional free-fall for front and/or rear drum(s). Includes internally expanding clutch assembly and external contracting band brake manually applied by foot pedal with locking latch in operator's cab. Operator may select free-fall or powered lowering mode using a selector switch.

Note: Free-fall drums are required for clamshell/dragline operations.

Optional auxiliary (third) hydraulic powered drum rated at 66,7 kN (15,000lb) line pull for third line over upper boom point, mounted on front of rotating bed. Includes third sheave for boom top wire rope guide and boom butt wire rope guide.

Optional auxiliary drum rated at 66,7 kN (15,000 lb) line pull as described above, mounted in boom butt.

Optional auxiliary drum preparation includes electric wiring and hydraulic plumbing.

Optional bolt-on liftcrane lagging.

Optional bolt-on clamshell lagging.

Optional wire rope for various applications (see page 12).

model 111



specifications



Boom Hoist

Independent two-drum boom hoist with grooved drums including 131,1 m (430') of 15,8 mm (5/8") diameter wire rope reeved with 10 parts of line.

Drums are powered by a fixed displacement hydraulic motor coupled to an internal brake and planetary gearbox equipped with ratcheting pawl.

Boom hoist speed: raise 57,9 m (190') full main boom from 0° - 81.5° in 80 seconds.



Swing System

High strength fabricated steel alloy rotating bed is mounted on 1,64 m (64-3/4") diameter turntable bearing.

Independent swing powered by a fixed displacement hydraulic motor coupled to a planetary gearbox with internal brake. 360° positive swing lock.

Swing system maximum speed: 3.6 rpm.



Counterweight

Total standard upper counterweight assembly is 19 960 kg (44,000 lb) consisting of one inner 12 930 kg (28,500 lb) counterweight and one outer 7 030 kg (15,500 lb) counterweight.

During self-assembly, the crane boom butt and hoist are used to lift the counterweights up onto lugs at the rear of the rotating bed upperworks via a tethered remote control. The counterweights are then secured in place by two hydraulic pins for fast, safe assembly.

➤ Optional Series B counterweight system consisting of one 2 585 kg (5,700 lb) center counterweight box and two carbody counterweights at 1 815 kg (4,000 lb) each. Includes connecting pins, retaining bolts, and washers.



Operator's Cab

Fully enclosed and insulated steel module mounted to the left front corner of rotating bed. Module is equipped with sliding door, large safety glass windows on all sides and roof. Signal horn, cab space heater, front and roof windshield wipers, dome light, sun visor and shade, fire extinguisher and air circulating fan are standard equipment.

- Optional air conditioning for operator's cab.
- Optional nylon protective window covers for operator's cab.

Attachments



No. 111 Heavy Lift Main Boom

The base liftcrane comes standard with a 12,2 m (40') No. 111 Basic Heavy-Lift tubular chord boom consisting of 6,4 m (21') butt and 5,8 m (19') open throat top with four 50,8 cm (20") diameter roller bearing sheaves on one shaft.

The basic heavy-lift boom also includes a boom angle indicator, pendant rigging, cushioned boom stops, and automatic boom hoist stop.

Anti-two block limit controls for main and whip lines.

4,7 m (15' 6") gantry and telescopic backhitch with sealed anti-friction bearings and nylon sheaves in gantry and equalizer system.

- Optional No. 111 3,0 m (10'), 6,1 m (20'), and 9,1 m (30') main boom inserts with pendants.
- Optional detachable upper boom point with one 50,8 cm (20") roller.



No. 111 Fixed Jib

- Optional No. 111 Basic Fixed Jib 9,1 m (30') length. Consisting of 4,6 m (15') jib butt and 4,6 m (15') jib top with 3,7 m (12') jib strut, pendants and backstay.
- Optional No. 111 Fixed Jib Inserts 3,0 m (10').

Utilize up to three fixed jib inserts in combination with the No. 111 Basic Fixed Jib for total lengths of 12,2 m (40'), 15,2 m (50'), and 18,3 m (60').

model 111



specifications

Lowerworks

4



Carbody

Steel fabricated carbody with wide flange wings for mounting to crawler side frames.

Two variable displacement travel motors driven through planetary gearboxes provide narrow-profile mounting within the crawler modules.



Crawlers

Crawler assemblies are 5,9 m (19' 4") long with 91,4 cm (36") wide triple grouser crawler pads.

Excavator-type crawlers have full counter-rotation capability.

Hydraulic extension/retraction of crawler assemblies with tethered remote control.

Maximum ground speed of 2,4 kph (1.5 mph).

Optional crawler handling package includes a high capacity wire rope guide mounted in the boom butt, sheave frame that attaches to the boom butt, single sheave 20 mton (22 ton) self-assembly block for 22 mm (7/8") or 31 mm (1-1/4") wire rope, and four 1,8m (6' 0") nylon eye round slings.

Optional Equipment

Blocks and hooks –

- ▶ 11 mton (12 ton) Swivel hook with 336 kg (740 lb) weight ball
- ▶ 11 mton (12 ton) Non-swivel hook with 336 kg (740 lb) weight ball
- ▶ 27 mton (30 ton) hook block with 2 sheaves, 22 mm (7/8") wire rope grooves
- ▶ 36 mton (40 ton) hook block with 2 sheaves, 22 mm (7/8") wire rope grooves
- ▶ 45 mton (50 ton) hook block with 3 sheaves, 22 mm (7/8") wire rope grooves
- ▶ 54 mton (60 ton) hook block with 3 sheaves, 22 mm (7/8") wire rope grooves
- ▶ 64 mton (70 ton) hook block with 4 sheaves, 22 mm (7/8") wire rope grooves
- ▶ 73 mton (80 ton) hook block with 4 sheaves, 22 mm (7/8") wire rope grooves

US Standard Tool Kit –

Includes all US tools required for routine maintenance (with the exception of a torque wrench).

Hydraulic Test Kit –

Required to properly analyze the performance of the EPIC® control system.

Service Interval Kits –

For the regularly scheduled maintenance of general crane operations.

Lighting Packages –

Consult Factory for available options.

Special Paint –

In colors other than Manitowoc standard red and black.

Special Customer Decals –

Custom vinyl decal(s) of name and/or logo from artwork supplied by customer.

Export Packaging –

Basic crane, boom and jib sections.

Additional Applications

Clamshell: Includes tagline, boom point roller guide, two 51,9 cm (20-7/16") laggings for 22 mm (7/8") wire rope, and pressure rollers for both front and rear drums.

Dragline: Includes fairlead, boom point roller guide, two 51,9 cm (20-7/16") laggings for 22 mm (7/8") wire rope, and pressure rollers for both front and rear drums.

Pile Driving: Includes shaft for attachment of fixed pile leads.



model 111



outline dimensions

5

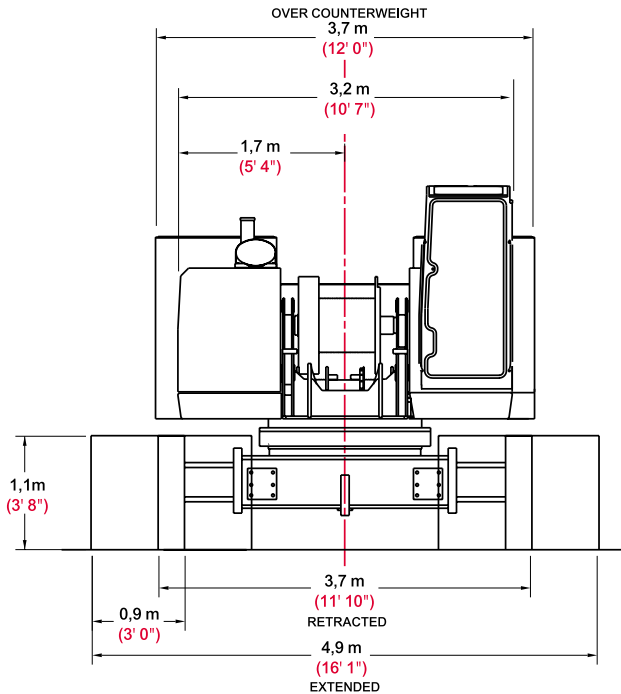
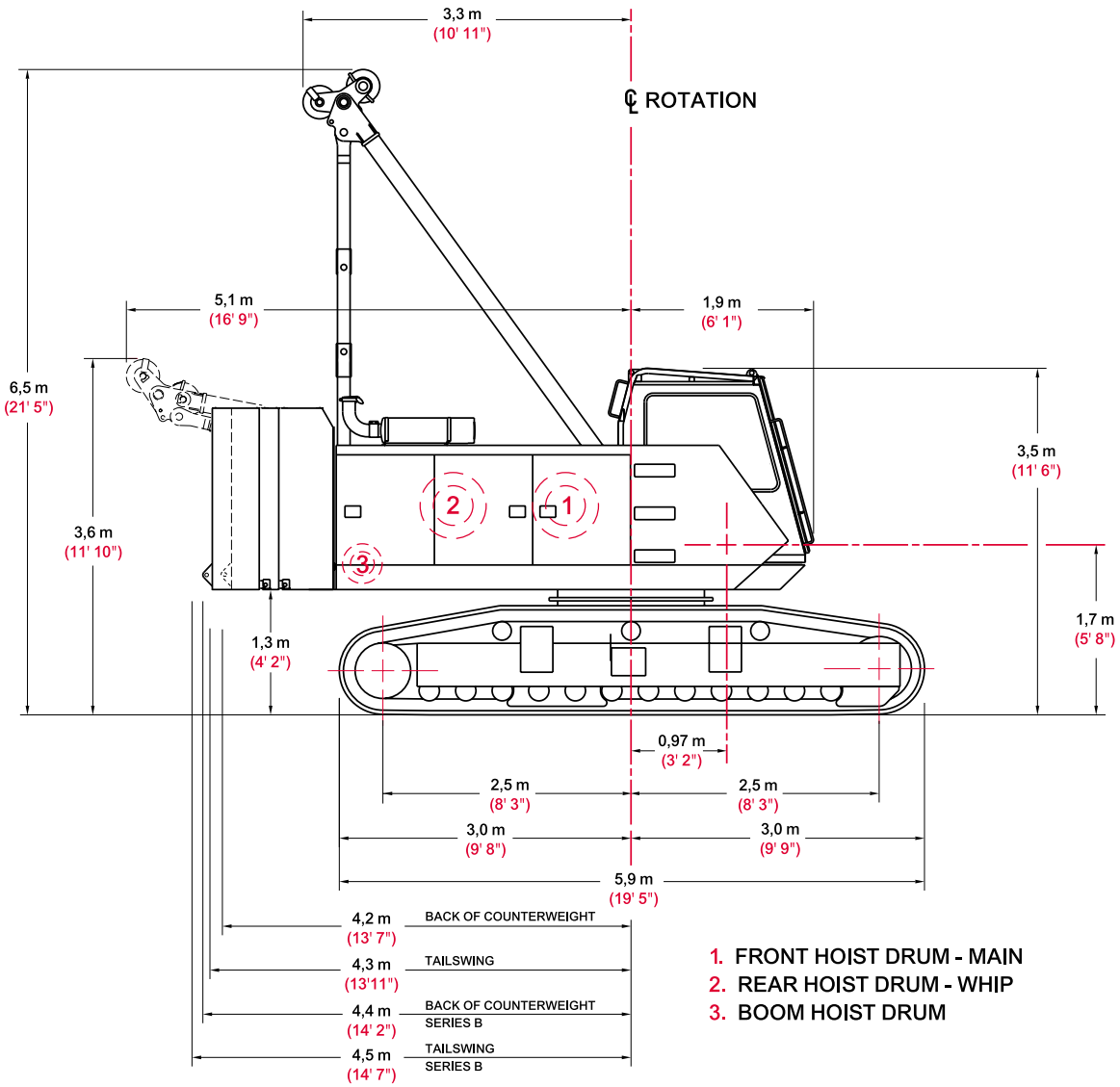

model 111



outline dimensions

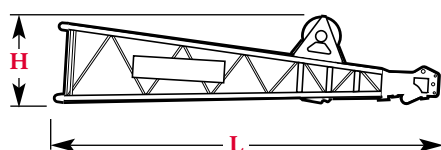
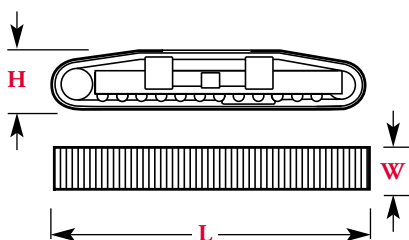
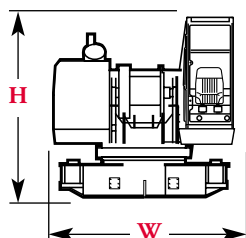
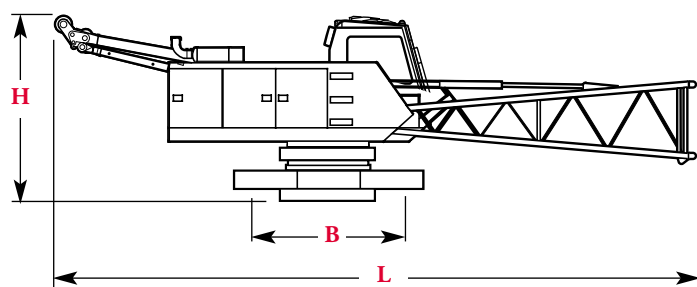
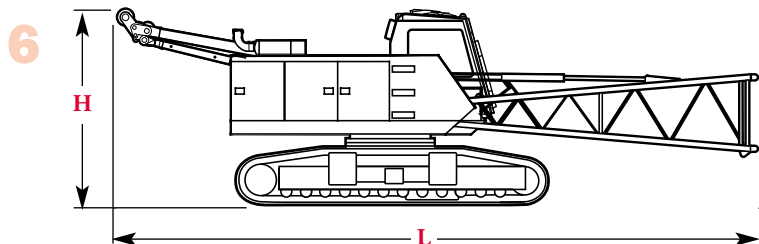

Basic Crane x 1

Length	12,5 m	40' 11"
Width (retracted)	3,6 m	11' 10"
Height	3,5 m	11' 6"
Weight	39 326 kg	86,700 lb

Note: Weight includes crawlers, carbody, and upperworks with hydraulic fluid, half tank of fuel, standard wire rope, gantry, and boom butt.

Basic Crane with crawlers removed x 1

Length	12,6 m	41' 2"
Width	3,3 m	10' 9"
Height	3,3 m	10' 7"
Base	2,6 m	8' 7"
Weight	25 768 kg	56,820 lb

Note: Weight includes carbody, and upperworks with hydraulic fluid, half tank of fuel, standard wire rope, gantry, and boom butt.

Crawlers x 2

Length	5,9 m	19' 4"
Width	0,9 m	3' 0"
Height	1,1 m	3' 7"
Weight	6 776 kg	14,940 lb

Boom top x 1

Length	5,8 m	20' 10"
Width	1,3 m	4' 4"
Height	1,7 m	5' 5"
Weight	980 kg	2,162 lb

model 111



outline dimensions

7

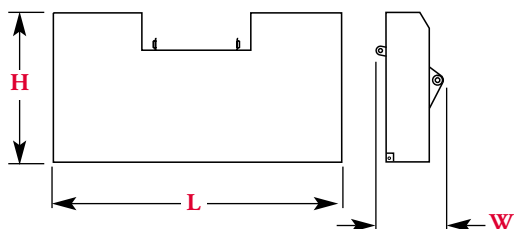

Inner Counterweight x 1

Length	3,7 m	12' 0"
Width	0,9 m	2' 9"
Height	1,9 m	6' 1"
Weight	12 930 kg	28,500 lb

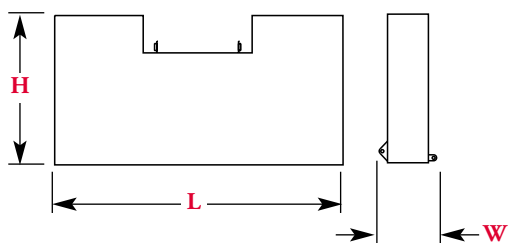

Outer Counterweight x 1

Length	3,7 m	12' 0"
Width	0,7 m	2' 2"
Height	1,9 m	6' 1"
Weight	7 030 kg	15,500 lb

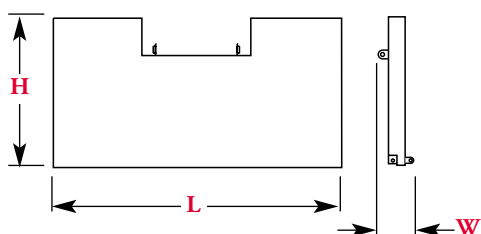

Mid Counterweight - Series B x 1

Length	3,7 m	12' 0"
Width	0,4 m	1' 3"
Height	1,9 m	6' 1"
Weight	2 585 kg	5,700 lb

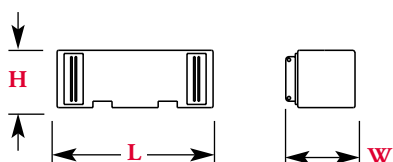

Carbody Weights - Series B x 2

Length	1,3 m	4' 3"
Width	0,6 m	1' 10"
Height	0,6 m	1' 11"
Weight each	1 814 kg	4,000 lb

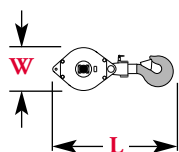

Hook block

Capacity	73 mt	80 t	Length	1,5 m	5' 0"
Weight	863 kg	1,899 lb	Width	0,6 m	2' 1"
Capacity	63,4 mt	70 t	Length	1,4 m	4' 8"
Weight	671 kg	1,477 lb	Width	0,6 m	2' 1"
Capacity	54,4 mt	60 t	Length	1,3 m	4' 4"
Weight	636 kg	1,400 lb	Width	0,6 m	2' 1"
Capacity	45,4 mt	50 t	Length	1,3 m	4' 4"
Weight	595 kg	1,310 lb	Width	0,6 m	2' 1"
Capacity	36,3 mt	40 t	Length	1,2 m	4' 1"
Weight	590 kg	1,300 lb	Width	0,6 m	2' 1"
Capacity	27,2 mt	30 t	Length	1,1 m	3' 9"
Weight	535 kg	1,178 lb	Width	0,6 m	2' 1"

Optional

model 111
Manitowoc



outline dimensions

8

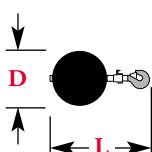
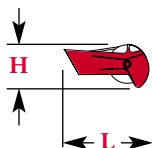
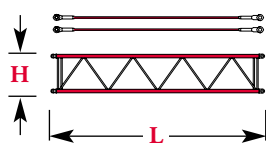
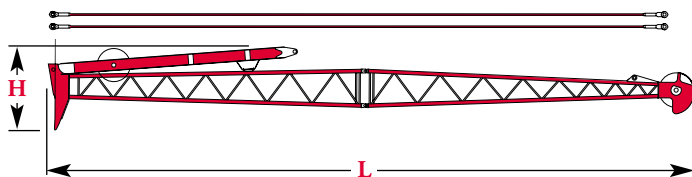
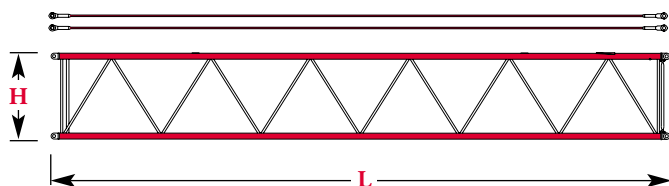
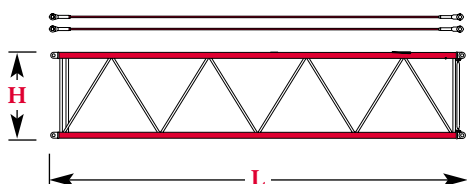
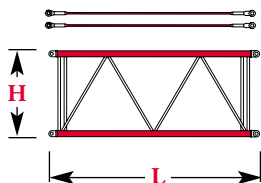

No. 111 Main Boom 3,1 m (10')		
Insert & Pendants x 1, 2		
Length	3,1 m	10' 4"
Width	1,3 m	4' 4"
Height	1,3 m	4' 4"
Weight	363 kg	800 lb

No. 111 Main Boom 6,1 m (20')		
Insert & Pendants x 1		
Length	6,1 m	20' 4"
Width	1,3 m	4' 4"
Height	1,3 m	4' 4"
Weight	612 kg	1,348 lb

No. 111 Main Boom 9,2 m (30')		
Insert & Pendants x 1, 2, 3		
Length	9,2 m	30' 4"
Width	1,3 m	4' 4"
Height	1,3 m	4' 4"
Weight	847 kg	1,865 lb

No. 111 Fixed Jib 9,2 m (30')		
Strut & Pendants x 1		
Length	9,3 m	31' 4"
Width	0,7 m	2' 4"
Height	1,3 m	4' 1"
Weight	728 kg	1,604 lb

No. 111 Jib Inserts 3,1 m (10')		
Strut & Pendants x 1, 2, 3		
Length	3,2 m	10' 3"
Width	0,7 m	2' 4"
Height	0,6 m	1' 10"
Weight	105 kg	232 lb

Upper Boom Point x 1		
Length	1,3 m	4' 2"
Width	0,7 m	2' 2"
Height	0,6 m	1' 9"
Weight	153 kg	338 lb

Weight Ball					
Capacity/Swivel	13,6 mt	12 t	Diameter	0,5 m	1' 6"
Weight	336 kg	740 lb	Length	1,2 m	4' 0"
Capacity/Non-Swivel	13,6 mt	12 t	Diameter	0,5 m	1' 6"
Weight	336 kg	740 lb	Length	1,2 m	4' 0"

Optional

model 111



transport data

Trailer Load Out Summary

Model 111 Series B
48,8 m (170') No. 111 Main Boom
18,3 m (60') No. 111 Fixed Jib

Item	Weight each Item kg (lb)	Quantity on Trailer Load #		
		1	2	3
No. 111 Basic Crane with Crawlers	39 326 (86,700)	1		
Standard Outer Counterweight	7 030 (15,500)		1	
Standard Inner Counterweight	12 930 (28,500)			1
Series B Middle Counterweight	2 585 (5,700)		1	
Series B Carbody Counterweight	1 814 (4,000)		1	1
9,2 m (30') No. 111 Boom Insert, Pendants	847 (1,865)		2	1
6,1 m (20') No. 111 Boom Insert, Pendants	612 (1,348)			1
3,0 m (10') No. 111 Boom Insert, Pendants	363 (800)		2	
Standard Boom Top 5,9 m (19')	980 (2,162)			1
Upper Boom Point	153 (338)		1	
9,2 m (30') No. 111 Fixed Jib Basic	728 (1,604)		1	
3,0 m (10') No. 111 Jib Insert, Pendants	105 (232)		3	
Hook Block 73 mton (80 ton)	863 (1,899)		1	
Weight Ball	331 (730)		1	
Approximate Total Shipping Weight kg (lb)		39 326 (86,700)	16 239 (35,797)	17 183 (37,875)

Shipping

Details

Two of the trailers used must be of a step-deck style. The trailer hauling the crane is usually a gooseneck style hydraulic lift low boy.

Use of good quality wooden blocks, braces and spacers is recommended. Securing the load properly will create a stable and strong structure for safe shipping.

Working Weight

	kg (lb)	
	111 Series B	111
12,2 m (40') No. 111 Main Boom	67 617 (149,071)	61 393 (135,374)
48,8 m (170') No. 111 Main Boom combined with 18,3 m (60') No. 111 Fixed Jib	72 595 (160,034)	66 377 (146,334)

Typical working weight consists of: hydraulic reservoirs full, fuel half-full, drums loaded with standard lengths of wire rope, upper boom point, 73 mt (80 t) hook block, and standard weight ball.

Note: Upper boom point not used with fixed jib.

Fast Self Assembly

Three Trucks, Three People, Three Hours

Extremely well designed and utilizing efficient use of space allows the Manitowoc Model 111 to be mobilized with only three people using three trucks in three hours - or less - with full boom and jib.

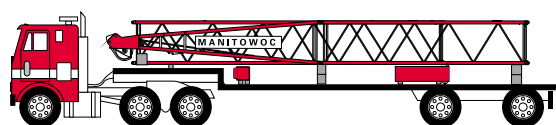
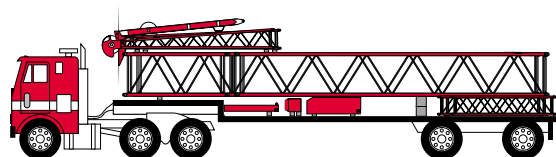
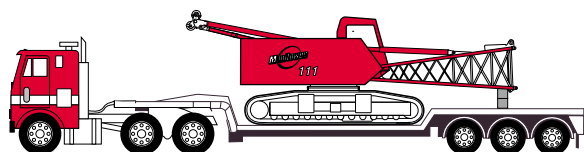

3 hours

model 111
Manitowoc



crane assembly

10

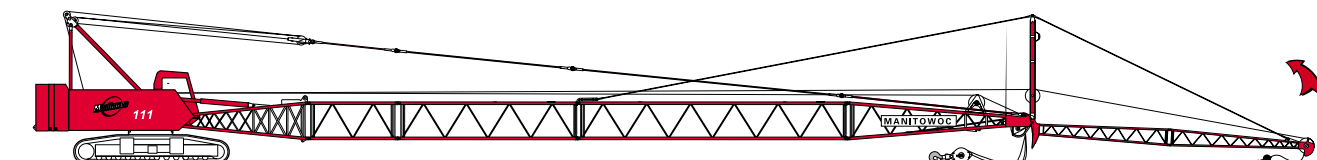
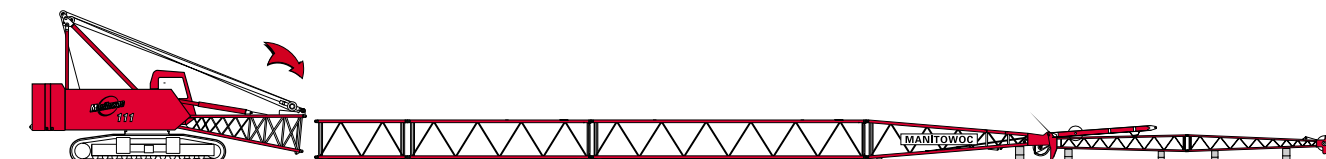
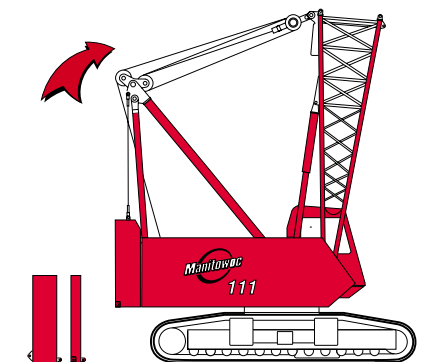
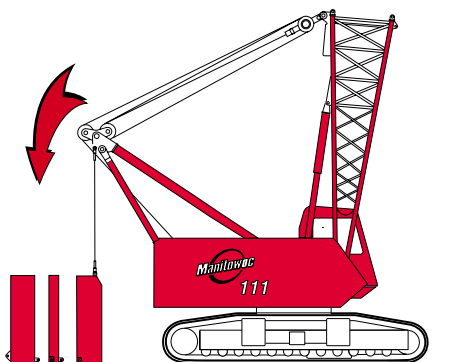
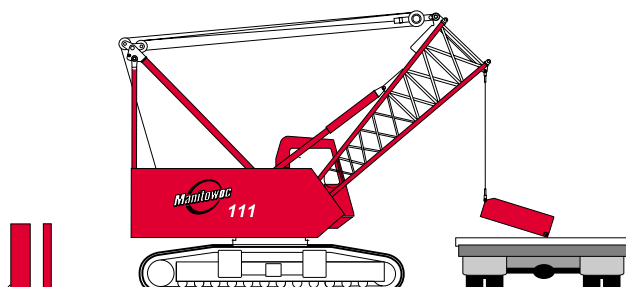
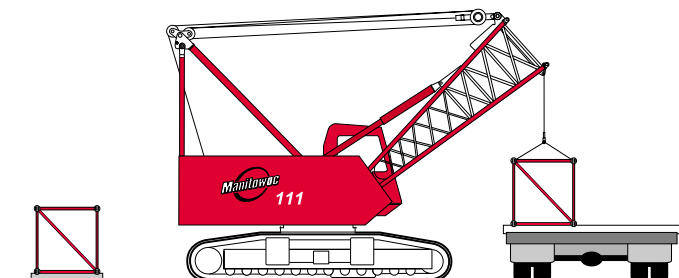
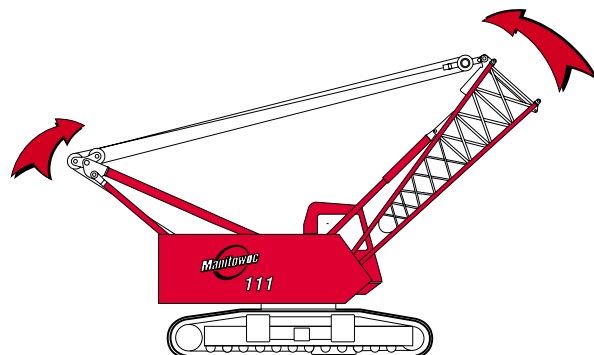
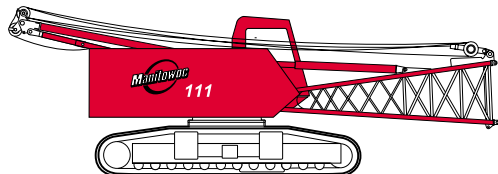

model 111



boom combinations

11

No. 111 Main Boom Combinations

Boom Length m (ft)	Inserts & Pendants		
	3,0 m (10 ft)	6,1 m (20 ft)	9,1 m (30 ft)
12,2 (40)	-	-	-
15,2 (50)	1	-	-
18,3 (60)	-	1	-
21,3 (70)	-	-	1
24,4 (80)	1	-	1
27,4 (90)	-	1	1
30,5 (100)	-	-	2
33,5 (110)	1	-	2
36,6 (120)	-	1	2
39,6 (130)	-	-	3
42,7 (140)	1	-	3
45,7 (150)	-	1	3
48,8 (160)	-	-	4
51,8 (170)	1	-	4
54,9 (180)	-	1	4
57,9 (190)	1	1	4

No. 111 Fixed Jib Combinations

Jib Length m (ft)	Inserts & Pendants
	3,1m (10 ft)
9,1 (30)	-
12,2 (40)	1
15,2 (50)	2
18,3 (60)	3

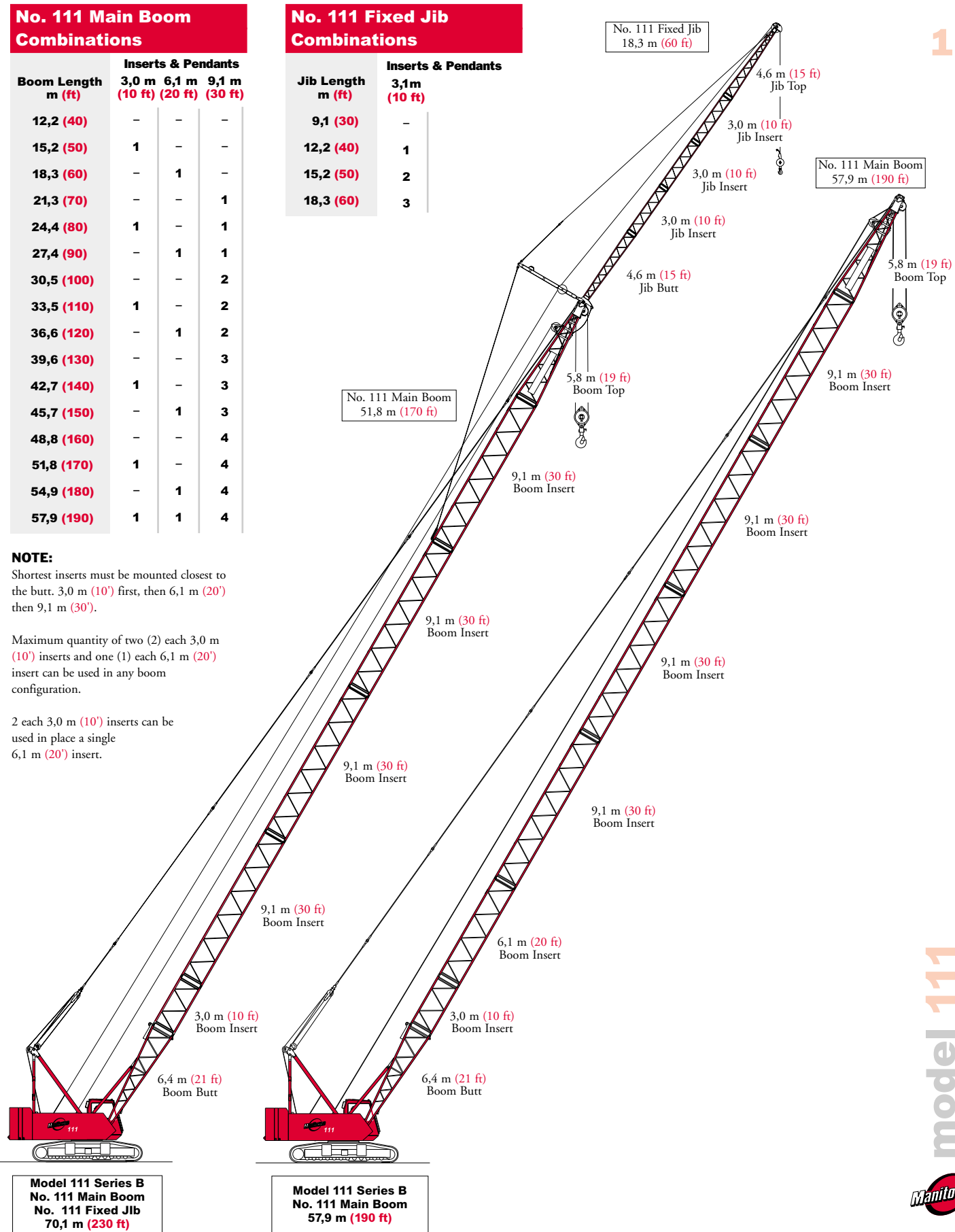

NOTE:

Shortest inserts must be mounted closest to the butt. 3,0 m (10') first, then 6,1 m (20') then 9,1 m (30').

Maximum quantity of two (2) each 3,0 m (10') inserts and one (1) each 6,1 m (20') insert can be used in any boom configuration.

2 each 3,0 m (10') inserts can be used in place a single 6,1 m (20') insert.

**Model 111 Series B
No. 111 Main Boom
No. 111 Fixed Jib
70,1 m (230 ft)**

**Model 111 Series B
No. 111 Main Boom
57,9 m (190 ft)**

model 111
Manitowoc

performance data

12

Wire Rope Lengths

Boom Length m (ft)	Whip line Rear Drum 1 part		Hoist line Front Drum		Maximum Required parts of line
	m	(ft)	m	(ft)	
12,2 (40)	32	(105)	122	(400)	8
15,2 (50)	38	(125)	149	(490)	8
18,3 (60)	44	(145)	177	(580)	8
21,3 (70)	50	(165)	207	(680)	8
24,4 (80)	56	(185)	207	(680)	7
27,4 (90)	62	(205)	207	(680)	6
30,5 (100)	69	(225)	221	(725)	6
33,5 (110)	75	(245)	221	(725)	5
36,6 (120)	81	(265)	221	(725)	4
39,6 (130)	87	(285)	221	(725)	4
42,7 (140)	93	(305)	221	(725)	4
45,7 (150)	99	(325)	221	(725)	3
48,8 (160)	105	(345)	221	(725)	3
51,8 (170)	111	(365)	221	(725)	3
54,9 (180)	117	(385)	221	(725)	2
57,9 (190)	123	(405)	221	(725)	2
61,0 (200)	130	(425)			
64,0 (210)	136	(445)			
67,1 (220)	142	(465)			
70,1 (230)	148	(485)			

Hoist Drums - 89 kN (20 kips)

Layer	Full Power Drum - Continuous Duty Single Line Pull/Single Line Speed					
	m/min (ft/min)					
	1	2	3	4	5	6
Line Pull kg (lb)						
0 (0)	121 (395)	131 (430)	142 (465)	152 (500)	163 (535)	174 (570)
2 270 (5,000)	113 (369)	122 (399)	131 (429)	140 (458)	148 (487)	157 (515)
4 540 (10,000)	105 (343)	112 (368)	119 (389)	120 (394)	122 (399)	123 (404)
6 810 (15,000)	83 (272)	84 (276)	86 (281)	87 (286)	89 (291)	90 (296)
9 070 (20,000)	66 (218)	68 (223)	69 (227)	71 (232)	72 (237)	74 (242)

Auxiliary Drum - 66,7 kN (15 kips)

Layer	Powered Drum - Continuous Duty Single Line Pull/Single Line Speed			
	m/min (ft/min)			
	1	2	3	4
Line Pull kg (lb)				
0 (0)	60 (196)	66 (215)	71 (234)	77 (252)
2 270 (5,000)	59 (193)	64 (209)	70 (228)	75 (245)
4 540 (10,000)	57 (188)	62 (204)	66 (218)	71 (232)
6 810 (15,000)	54 (176)			

Drum Capacities - Wire Rope

	Maximum Length With 6 Layers	
	No Lagging	With Lagging
Front Drum 22 mm (7/8") Wire Rope	250 m (819 ft)	265 m (870 ft)
Rear Drum 22 mm (7/8") Wire Rope	250 m (819 ft)	265 m (870 ft)
Hoist Drum 15,8 mm (5/8") Wire Rope	131 m (430 ft)	

Wire Rope Specifications - 22 mm (7/8")

Function	3.5:1 Safety Factor Regular Lay, 6x25 Filler Wire, Extra Improved Plow Steel, IWRC MCC Part No. 719111		5:1 Safety Factor Rotation Resistant, 2 160 N/mm ² DYFORM 34LR 2160 MCC Part No. 719414	
	Hoist Line	Whip Line	Hoist Line	Whip Line
Minimum Breaking Strength	36 110 kg (79,600 lb)	36 110 kg (79,600 lb)	48 140 kg (106,120 lb)	48 140 kg (106,120 lb)
Maximum Load Per Line		9 070 kg (20,000 lb)		9 070 kg (20,000 lb)
Approximate Weight	2,11 kg/m (1.42 lb/ft)	2,11 kg/m (1.42 lb/ft)	2,46 kg/m (1.65 lb/ft)	2,46 kg/m (1.65 lb/ft)

model 111



performance data

13

Maximum Length – Unassisted Raising

No. 111 Main Boom & No. 111 Fixed Jib				
	111 Series B		111	
	Boom	Jib	Boom	Jib
Over front of blocked crawlers	57,9 (190)	–	57,9 (190)	–
	54,9 (180)	15,2 (50)	54,9 (180)	9,1 (30)
m (ft)	51,8 (170)	18,3 (60)	51,8 (170)	15,2 (50)
	48,8 (160)	18,3 (60)	48,8 (160)	18,3 (60)
	45,7 (150)	18,3 (60)	45,7 (150)	18,3 (60)
Over side of extended crawlers	57,9 (190)	–	57,9 (190)	–
	54,9 (180)	–	54,9 (180)	–
m (ft)	51,8 (170)	12,2 (40)	51,8 (170)	–
	48,8 (160)	18,3 (60)	48,8 (160)	12,2 (40)
	45,7 (150)	18,3 (60)	45,7 (150)	18,3 (60)
Over side of retracted crawlers	48,8 (160)	–	–	–
	45,7 (150)	–	–	–
m (ft)	42,7 (140)	9,1 (30)	–	–
	39,6 (130)	18,3 (60)	–	–

NOTE: Load block, hook and weight ball on ground at start.



model 111



main boom range diagram

14

No. 111 Main Boom

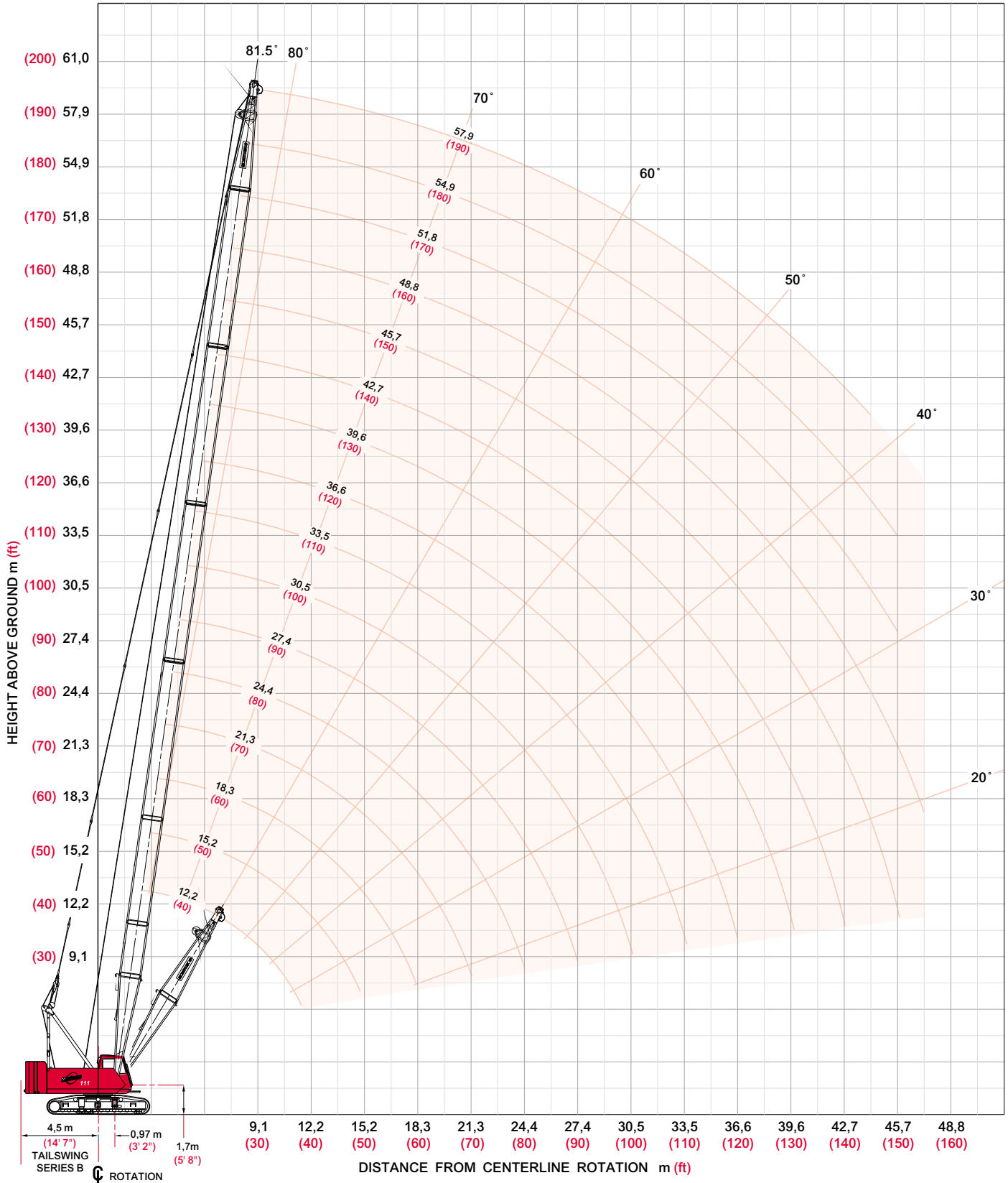

model 111



main boom load charts

Liftcrane Boom Capacities - Series B

Boom No. 111 with Open Throat Top

22 540 kg (49,700 lb) Counterweight 3 630 kg (8,000 lb) Carbody counterweight
5,89 m (19' 4") Crawlers extended

360° Rating kg (lb) x 1 000

Boom m (ft)	12,2 (40)	18,3 (60)	24,4 (80)	30,5 (100)	36,6 (120)	42,7 (140)	48,8 (160)	54,9 (180)	57,9 (190)
Radius									
3,0 (10)	72,5 (160.0)								
4,5 (15)	64,8 (139.5)	64,4 (139.5)							
6,0 (20)	39,9 (86.0)	39,9 (85.9)	39,8 (85.7)	39,7 (85.4)					
9,0 (30)	22,2 (48.8)	22,1 (47.8)	21,9 (47.4)	21,8 (47.2)	21,6 (46.8)	21,5 (46.5)	20,9 (46.1)		
12,0 (40)	15,1 (32.8)	15,0 (32.5)	14,9 (32.2)	14,7 (31.9)	14,6 (31.6)	14,4 (31.2)	14,2 (30.8)	14,1 (30.4)	12,8 (27.9)
18,0 (60)		8,8 (19.2)	8,7 (18.9)	8,6 (18.6)	8,4 (18.3)	8,2 (17.9)	8,0 (17.5)	7,9 (17.1)	7,8 (16.9)
24,0 (80)			5,9 (12.8)	5,7 (12.5)	5,6 (12.2)	5,4 (11.7)	5,3 (11.4)	5,1 (11.0)	5,0 (10.7)
30,0 (100)				4,2 (9.1)	4,0 (8.7)	3,8 (8.2)	3,6 (7.9)	3,4 (7.5)	3,3 (7.2)
36,0 (120)					2,9 (6.4)	2,8 (6.0)	2,6 (5.6)	2,4 (5.2)	2,3 (5.0)
42,0 (140)						2,0 (4.4)	1,8 (4.0)	1,6 (3.6)	1,5 (3.4)
46,0 (155)							1,5 (3.1)		

15

Main Boom with Jib 111 Series B & 111

Jib Length m (ft)	Deduct from Capacity with Fixed Jib attached kg (lb)
9,1 (30)	730 (1,600)
12,2 (40)	910 (2,000)
15,2 (50)	1 130 (2,500)
18,3 (60)	1 360 (3,000)

Liftcrane Boom Capacities

Boom No. 111 with Open Throat Top

19 960 kg (44,000 lb) Counterweight

5,9 m (19' 4") Crawlers extended

360° Rating kg (lb) x 1 000

Boom m (ft)	12,2 (40)	18,3 (60)	24,4 (80)	30,5 (100)	36,6 (120)	42,7 (140)	48,8 (160)	54,9 (180)	57,9 (190)
Radius									
3,0 (10)	72,5 (160.0)								
4,5 (15)	59,3 (125.7)	59,3 (125.7)							
6,0 (20)	35,9 (77.4)	35,9 (77.3)							
9,0 (30)	19,9 (43.1)	19,8 (42.8)	19,6 (42.5)	19,5 (42.2)	19,4 (41.9)	19,2 (41.5)	19,1 (41.1)		
12,0 (40)	13,6 (29.4)	13,4 (29.1)	13,3 (28.8)	13,1 (28.5)	13,0 (28.1)	12,8 (27.7)	12,6 (27.4)	12,5 (27.0)	12,5 (26.8)
18,0 (60)		7,8 (17.0)	7,7 (16.7)	7,6 (16.5)	7,4 (16.1)	7,2 (15.7)	7,1 (15.4)	6,9 (15.0)	6,8 (14.8)
24,0 (80)			5,2 (11.2)	5,0 (11.0)	4,9 (10.6)	4,7 (10.2)	4,5 (9.8)	4,3 (9.4)	4,2 (9.2)
30,0 (100)				3,6 (7.8)	3,4 (7.4)	3,2 (7.0)	3,0 (6.6)	2,9 (6.2)	2,8 (6.0)
36,0 (120)					2,5 (5.4)	2,3 (5.0)	2,1 (4.6)	1,9 (4.2)	1,8 (4.0)
42,0 (140)						1,6 (3.6)	1,5 (3.2)		

Meets ANSI B30.5 Requirements - Capacities do not exceed 75% of static tipping load.
NOTICE: This capacity chart is for reference only and must not be used for lifting purposes.

model 111



fixed jib range diagram

No. 111 Fixed Jib on No. 111 Main Boom

16

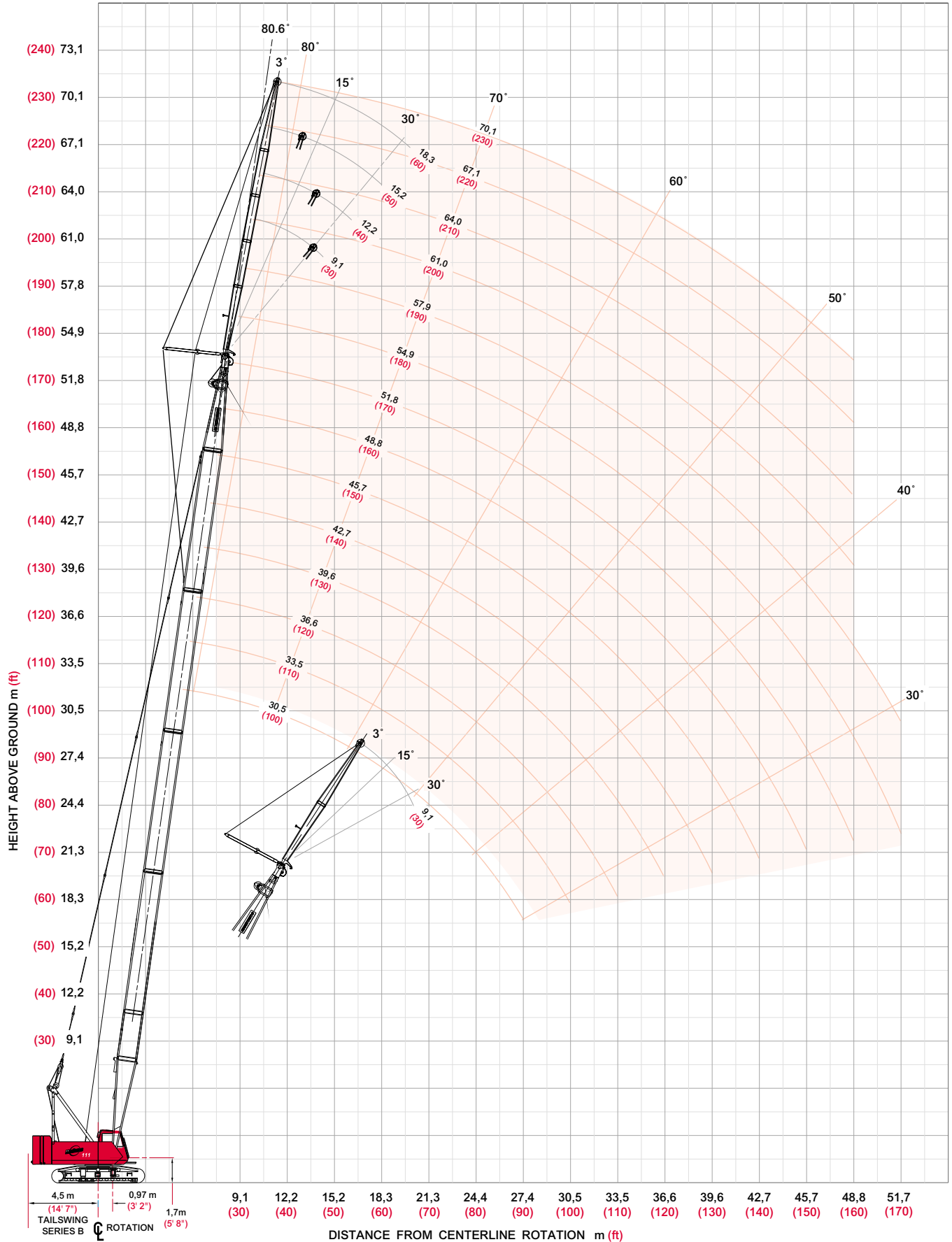

fixed jib load charts

17

Liftcrane Jib Capacities - Series B

Jib No. 111 with 3,7 m (12 ft) Strut on Boom No. 111 with Open Throat Top

22 540 kg (49,700 lb) Counterweight 3 630 kg (8,000 lb) Carbody counterweight

5,89 m (19' 4") Crawlers extended

360° Rating

kg (lb) x 1 000

Boom m (ft)	3° Offset					30° Offset				
	21,3 (70)	27,4 (90)	36,6 (120)	45,7 (150)	54,9 (180)	21,3 (70)	27,4 (90)	36,6 (120)	45,7 (150)	54,9 (180)
Radius										
7,6 (25)	9,0 (20.0)	9,0 (20.0)								
10,0 (30)	9,0 (20.0)	9,0 (20.0)	9,0 (20.0)							
12,0 (40)	9,0 (20.0)	9,0 (20.0)	9,0 (20.0)	9,0 (20.0)	- (19.1)	8,1 (17.9)	- (18.5)			
14,0 (50)	9,0 (20.0)	9,0 (20.0)	9,0 (20.0)	9,0 (20.0)	8,5 (18.6)	7,6 (16.2)	7,9 (17.0)	8,3 (17.8)	- (18.4)	
18,0 (60)	8,9 (19.8)	8,8 (19.3)	8,5 (18.7)	8,3 (18.0)	7,9 (17.4)	6,7 (14.8)	7,1 (15.7)	7,5 (16.6)	7,9 (17.4)	7,1 (15.7)
26,0 (80)	5,5 (13.5)	5,4 (13.0)	5,0 (12.4)	4,7 (11.7)	4,4 (11.0)	- (13.0)	5,5 (13.4)	5,3 (12.9)	5,0 (12.4)	4,8 (11.9)
30,0 (100)	4,5 (9.9)	4,3 (9.4)	4,0 (8.7)	3,7 (8.0)	3,4 (7.3)			4,2 (9.1)	3,9 (8.5)	3,7 (8.0)
38,0 (120)			2,6 (6.4)	2,3 (5.7)	2,0 (5.0)				2,5 (6.0)	2,2 (5.4)
42,0 (140)			2,2 (4.7)	1,8 (4.0)	1,5 (3.3)					1,7 (3.6)
46,0 (150)				1,4 (3.3)						

Boom m (ft)	3° Offset					30° Offset				
	21,3 (70)	27,4 (90)	36,6 (120)	45,7 (150)	54,9 (180)	21,3 (70)	27,4 (90)	36,6 (120)	45,7 (150)	54,9 (180)
Radius										
7,6 (25)	9,0 (20.0)									
10,0 (30)	9,0 (20.0)	9,0 (20.0)								
12,0 (40)	9,0 (20.0)	9,0 (20.0)	9,0 (20.0)	- (20.0)						
14,0 (50)	9,0 (20.0)	9,0 (20.0)	9,0 (20.0)	9,0 (20.0)	7,6 (16.8)	6,6 (14.1)	6,8 (14.6)	- (15.2)		
18,0 (60)	9,0 (19.9)	8,8 (19.5)	8,6 (18.9)	8,4 (18.2)	7,4 (16.4)	5,8 (12.9)	6,1 (13.5)	6,4 (14.2)	6,7 (14.7)	- (13.4)
26,0 (80)	5,6 (13.6)	5,4 (13.2)	5,1 (12.5)	4,8 (11.8)	4,5 (11.2)	4,8 (11.1)	5,1 (11.7)	5,4 (12.5)	5,2 (12.8)	5,0 (12.3)
30,0 (100)	4,6 (10.0)	4,4 (9.6)	4,1 (8.9)	3,8 (8.2)	3,5 (7.5)		4,6 (9.9)	4,3 (9.4)	4,1 (8.9)	3,8 (8.3)
38,0 (120)		3,0 (7.2)	2,7 (6.5)	2,4 (5.8)	2,1 (5.1)			2,8 (6.8)	2,6 (6.3)	2,3 (5.7)
42,0 (140)			2,2 (4.8)	1,9 (4.1)	1,6 (3.4)				2,1 (4.5)	1,8 (3.9)
46,0 (150)			1,8 (4.2)	1,5 (3.5)						- (3.2)

Meets ANSI B30.5 Requirements - Capacities do not exceed 75% of static tipping load.
 NOTICE: This capacity chart is for reference only and must not be used for lifting purposes.



fixed jib load charts

18

Liftcrane Jib Capacities - Series B Jib No. 111 with 3,7 m (12 ft) Strut on Boom No. 111 with Open Throat Top

22 540 kg (49,700 lb) Counterweight 3 630 kg (8,000 lb) Carbody counterweight

5,89 m (19' 4") Crawlers extended

360° Rating

kg (lb) x 1 000

Boom m (ft)	3° Offset					30° Offset				
	21,3 (70)	27,4 (90)	36,6 (120)	45,7 (150)	54,9 (180)	21,3 (70)	27,4 (90)	36,6 (120)	45,7 (150)	54,9 (180)
Radius										
10,0 (30)	8,8 (19.7)	8,9 (20.0)								
12,0 (40)	8,5 (18.7)	8,6 (19.1)	8,9 (19.7)	- (20.0)						
14,0 (50)	8,2 (17.8)	8,4 (18.3)	8,7 (18.9)	8,9 (19.4)	6,9 (15.2)	- (13.0)				
18,0 (60)	7,7 (17.0)	7,9 (17.5)	8,2 (18.2)	8,3 (18.3)	6,7 (14.8)	5,4 (11.8)	5,6 (12.3)	5,8 (12.8)	- (13.2)	
26,0 (80)	5,7 (13.7)	5,5 (13.3)	5,1 (12.6)	4,9 (11.9)	4,5 (11.3)	4,3 (10.0)	4,6 (10.6)	4,9 (11.3)	5,1 (11.4)	4,7 (10.5)
30,0 (100)	4,6 (10.1)	4,4 (9.7)	4,1 (9.0)	3,8 (8.3)	3,5 (7.6)	4,0 (8.8)	4,3 (9.4)	4,4 (9.6)	4,2 (9.1)	4,0 (8.6)
38,0 (120)		3,0 (7.3)	2,7 (6.6)	2,4 (5.9)	2,1 (5.2)			2,9 (7.1)	2,7 (6.5)	2,5 (6.0)
42,0 (140)			2,3 (4.9)	1,9 (4.2)	1,6 (3.5)				2,2 (4.7)	1,9 (4.1)
46,0 (160)				1,9 (3.7)	1,6 (3.0)				1,7 (3.7)	1,5 (3.3)
50,0 (170)					1,5 (3.3)					-

Boom m (ft)	3° Offset					30° Offset				
	21,3 (70)	27,4 (90)	36,6 (120)	45,7 (150)	51,8 (170)	21,3 (70)	27,4 (90)	36,6 (120)	45,7 (150)	51,8 (170)
Radius										
10,0 (30)	7,2 (16.0)									
12,0 (40)	7,1 (15.7)	7,2 (16.0)	- (16.0)							
14,0 (50)	6,9 (15.0)	7,0 (15.4)	7,2 (15.9)	7,2 (16.0)	6,8 (14.9)					
18,0 (60)	6,5 (14.3)	6,7 (14.8)	6,9 (15.3)	7,1 (15.7)	6,6 (14.6)	4,8 (10.6)	- (10.9)			
26,0 (80)	5,7 (13.1)	5,5 (13.3)	5,2 (12.7)	4,9 (12.0)	4,6 (11.5)	3,7 (8.7)	4,0 (9.2)	4,2 (9.9)	4,3 (9.6)	4,0 (9.1)
30,0 (100)	4,7 (10.2)	4,5 (9.7)	4,1 (9.0)	3,8 (8.3)	3,6 (7.9)	3,3 (7.4)	3,6 (8.0)	3,9 (8.6)	4,1 (9.2)	3,9 (8.7)
38,0 (120)	3,3 (7.8)	3,1 (7.3)	2,8 (6.6)	2,5 (6.0)	2,2 (5.5)		3,1 (7.1)	3,0 (7.2)	2,8 (6.7)	2,6 (6.4)
42,0 (140)		2,6 (5.7)	2,3 (5.0)	2,0 (4.3)	1,8 (3.8)			2,5 (5.4)	2,3 (4.9)	2,1 (4.5)
46,0 (160)			1,9 (3.7)	1,6 (3.0)					1,8 (3.5)	1,6 (3.1)
50,0 (170)				1,6 (3.2)					1,4 (3.1)	-

model 111



Meets ANSI B30.5 Requirements - Capacities do not exceed 75% of static tipping load.
NOTICE: This capacity chart is for reference only and must not be used for lifting purposes.

fixed jib load charts

19

Liftcrane Jib Capacities Jib No. 111 with 3,7 m (12 ft) Strut on Boom No. 111 with Open Throat Top

19 960 kg (44,000 lb) Counterweight
5,89 m (19' 4") Crawlers extended
360° Rating kg (lb) x 1 000

Jib Length 9,1 m (30 ft)	3° Offset					30° Offset				
	21,3 (70)	27,4 (90)	36,6 (120)	45,7 (150)	54,9 (180)	21,3 (70)	27,4 (90)	36,6 (120)	45,7 (150)	54,9 (180)
Radius										
7,6 (25)	9,0 (20.0)	9,0 (20.0)								
10,0 (30)	9,0 (20.0)	9,0 (20.0)	9,0 (20.0)							
12,0 (40)	9,0 (20.0)	9,0 (20.0)	9,0 (20.0)	9,0 (20.0)	- (19.1)	8,1 (17.9)				
14,0 (50)	9,0 (20.0)	9,0 (20.0)	9,0 (20.0)	9,0 (20.0)	8,5 (18.6)	7,6 (16.2)	7,9 (17.0)	8,3 (17.5)	- (18.4)	
18,0 (60)	8,1 (17.4)	7,9 (17.0)	7,6 (16.3)	7,2 (15.7)	7,0 (15.0)	6,7 (14.8)	7,1 (15.7)	7,5 (16.3)	7,7 (16.7)	7,1 (15.7)
26,0 (80)	4,8 (11.8)	4,6 (11.3)	4,3 (10.6)	4,0 (10.0)	3,7 (9.3)	- (12.0)	4,8 (11.7)	4,6 (11.3)	4,3 (10.7)	4,1 (10.1)
30,0 (100)	3,9 (8.5)	3,7 (8.1)	3,4 (7.4)	3,1 (6.7)	2,8 (6.0)			3,6 (7.9)	3,3 (7.2)	3,0 (6.6)
38,0 (120)			2,1 (5.3)	1,8 (4.6)	1,5 (3.9)				2,0 (4.9)	1,7 (4.3)
42,0 (140)			1,7 (3.8)	1,4 (3.1)						

Jib Length 12,2 m (40 ft)	3° Offset					30° Offset				
	21,3 (70)	27,4 (90)	36,6 (120)	45,7 (150)	51,8 (170)	21,3 (70)	27,4 (90)	36,6 (120)	45,7 (150)	51,8 (170)
Radius										
7,6 (25)	9,0 (20.0)									
10,0 (30)	9,0 (20.0)	9,0 (20.0)								
12,0 (40)	9,0 (20.0)	9,0 (20.0)	9,0 (20.0)	- (20.0)						
14,0 (50)	9,0 (20.0)	9,0 (20.0)	9,0 (20.0)	9,0 (20.0)	8,7 (19.0)	6,6 (14.1)	6,8 (14.6)	- (15.2)		
18,0 (60)	8,2 (17.6)	7,9 (17.1)	7,7 (16.5)	7,3 (15.9)	7,2 (15.4)	5,8 (12.9)	6,1 (13.5)	6,4 (14.2)	6,7 (14.7)	- (14.1)
26,0 (80)	4,9 (11.9)	4,7 (11.5)	4,4 (10.8)	4,1 (10.1)	3,9 (9.7)	4,8 (11.1)	4,9 (11.7)	4,7 (11.5)	4,5 (11.1)	4,3 (10.7)
30,0 (100)	4,0 (8.7)	3,8 (8.2)	3,4 (7.5)	3,1 (6.8)	2,9 (6.4)		3,9 (8.5)	3,7 (8.0)	3,5 (7.5)	3,3 (7.1)
38,0 (120)		2,5 (6.1)	2,2 (5.4)	1,9 (4.7)	1,7 (4.2)			2,4 (5.7)	2,1 (5.2)	1,9 (4.8)
42,0 (140)			1,8 (3.9)	1,5 (3.2)					1,6 (3.5)	1,4 (3.1)
46,0 (150)			1,4 (3.3)							

Meets ANSI B30.5 Requirements - Capacities do not exceed 75% of static tipping load.
NOTICE: This capacity chart is for reference only and must not be used for lifting purposes.



model 111

fixed jib load charts

20

Liftcrane Jib Capacities Jib No. 111 with 3,7 m (12 ft) Strut on Boom No. 111 with Open Throat Top

19 960 kg (44,000 lb) Counterweight

5,89 m (19' 4") Crawlers extended

360° Rating

kg (lb) x 1 000

Boom m (ft)	3° Offset					30° Offset				
	21,3 (70)	27,4 (90)	36,6 (120)	45,7 (150)	51,8 (170)	21,3 (70)	27,4 (90)	36,6 (120)	45,7 (150)	51,8 (170)
Jib Length 15,2 m (50 ft)										
Radius										
10,0 (30)	8,8 (19.7)	8,9 (20.0)								
12,0 (40)	8,5 (18.7)	8,6 (19.1)	8,9 (19.7)	- (20.0)						
14,0 (50)	8,2 (17.8)	8,4 (18.3)	8,7 (18.9)	8,9 (19.4)	7,7 (17.0)	- (13.0)				
18,0 (60)	7,7 (17.0)	7,8 (17.2)	7,7 (16.6)	7,4 (16.0)	7,1 (15.5)	5,4 (11.8)	5,6 (12.3)	5,8 (12.8)	- (13.2)	
26,0 (80)	4,9 (12.0)	4,7 (11.6)	4,4 (10.9)	4,1 (10.2)	3,9 (9.8)	4,3 (10.0)	4,6 (10.6)	4,8 (11.3)	4,6 (11.4)	4,5 (10.8)
30,0 (100)	4,0 (8.8)	3,8 (8.3)	3,5 (7.6)	3,2 (6.9)	2,9 (6.4)	4,0 (8.8)	4,1 (8.8)	3,8 (8.3)	3,6 (7.8)	3,4 (7.4)
38,0 (120)			2,6 (6.2)	2,3 (5.5)	2,0 (4.8)			2,5 (5.9)	2,2 (5.4)	2,1 (5.1)
42,0 (140)				1,8 (4.0)	1,5 (3.3)				1,7 (3.7)	1,5 (3.4)
46,0 (150)					1,5 (3.4)				- (3.1)	

Boom m (ft)	3° Offset					30° Offset				
	21,3 (70)	27,4 (90)	36,6 (120)	45,7 (150)	48,8 (160)	21,3 (70)	27,4 (90)	36,6 (120)	45,7 (150)	48,8 (160)
Jib Length 18,3 m (60 ft)										
Radius										
9,1 (25)	7,2 (16.0)									
10,0 (30)	7,2 (16.0)									
12,0 (40)	7,1 (15.7)	7,2 (16.0)	- (16.0)							
14,0 (50)	6,9 (15.0)	7,0 (15.4)	7,2 (15.9)	7,2 (16.0)	7,2 (16.0)					
18,0 (60)	6,5 (14.3)	6,7 (14.8)	6,9 (15.3)	7,1 (15.7)	7,1 (15.8)	4,8 (10.6)	- (10.9)			
26,0 (80)	5,0 (12.1)	4,7 (11.6)	4,5 (10.9)	4,1 (10.3)	4,1 (10.0)	3,7 (8.7)	4,0 (9.2)	4,2 (9.9)	4,3 (9.6)	4,1 (9.3)
30,0 (100)	4,0 (8.8)	3,8 (8.3)	3,5 (7.7)	3,2 (7.0)	3,1 (6.7)	3,3 (7.4)	3,6 (8.0)	3,9 (8.5)	3,7 (8.0)	3,6 (7.9)
38,0 (120)	2,8 (6.7)	2,6 (6.2)	2,3 (5.5)	2,0 (4.8)	1,9 (4.6)		2,7 (6.6)	2,5 (6.1)	2,3 (5.6)	2,2 (5.5)
42,0 (140)			2,2 (4.7)	1,8 (4.0)	1,5 (3.3)			2,0 (4.4)	1,8 (3.9)	1,7 (3.7)
46,0 (150)				1,5 (3.4)					- (3.2)	- (3.1)

model 111



Meets ANSI B30.5 Requirements - Capacities do not exceed 75% of static tipping load.
NOTICE: This capacity chart is for reference only and must not be used for lifting purposes.

CraneCARESM

CraneCARE is Manitowoc's comprehensive service and support program. It includes classroom and on-site training, prompt parts availability, expert field service, technical support and documentation — for every one of the more than 7,000 Manitowoc cranes currently in use throughout the world.

That's commitment you won't find anywhere else.

That's **CraneCARE**.

Service Training

Manitowoc specialists work with you in our training center and in the field to make sure you know how to get maximum performance, reliability, and life from your cranes.

Manitowoc Cranes Technical Training Center provides valuable multi-level training, which is available for all models and attachments, in the following format:

- Basic – Provides technicians with the basic skills required in our Level I and II classes covering hydraulic and electrical theory and schematics, pump, motor, control, and LMI operation, and the use of meters and gauges.
- Level one – This model-specific class covers theory and offers hands-on training and trouble shooting for all crane systems.
- Level two – This model-specific class provides in-depth coverage of all crane systems and components, and advanced troubleshooting of simulated faults. (Requires Level I.)
- Masters – Covering all EPIC models and the 4100W, this class stresses high level system knowledge and trouble shooting of simulated faults. (Requires Level II.)

Parts Availability

Genuine Manitowoc replacement parts are accessible through your distributor 24 hours a day, 7 days a week, 365 days a year.

Service Interval Kits

Provides all the parts required by Manitowoc's Preventative Maintenance Checklist.

200 Hour – Part No. 499970-0

Consists of the following:

- Engine Water Filter (Part No. 413360-0)
- Primary Fuel Filter (Part No. 413392-0)
- Secondary Fuel Filter (Part No. 413393-0)
- Engine Oil Filter (Part No. 413394-0)
- Primary Air Filter (Part No. 426721-0)
- Secondary Air Filter (Part No. 426726-0)

1,000 Hour – Part No. 499971-0

Consists of the entire 200 Hour Service Kit (Part No. 499970-0), plus the following:

- Hydraulic Filter in Tank (Part No. 426727-0)
- Filter, Breather (Part No. 910636-2)
- Hydraulic Filter - Spin on (Part No. 970150-2)

2,000 Hour – Part No. 499972-0

Consists of the entire 1,000 Hour Service Kit (Part No. 499971-0), plus the following:

- Compressor Belt (Part No. 227220-0)

Hydraulic Test Kit – Part No. 499791-6

Protect your investment by demanding Genuine Manitowoc Parts Service Kits. The Hydraulic Service Kit consist of the following:

- All hydraulic fittings to access all pressures and flows
- Hydraulic flow meters and pressure gauges to record hydraulic data.
- Electrical "Break out" harnesses to access voltages on all electrical circuits on all machines.
- Fluke® Digital volt ohm meter, as used in all Manitowoc service literature.

Hydraulic Test Kit with case – Part No. 499792-9

The above kit (Part No. 4299791-6) plus a custom heavy-duty carrying case.

U.S. Standard Tools Kit – Part No. 22205-1

All standard tools needed to properly maintain and service your crane. (Does not include torque wrench.)

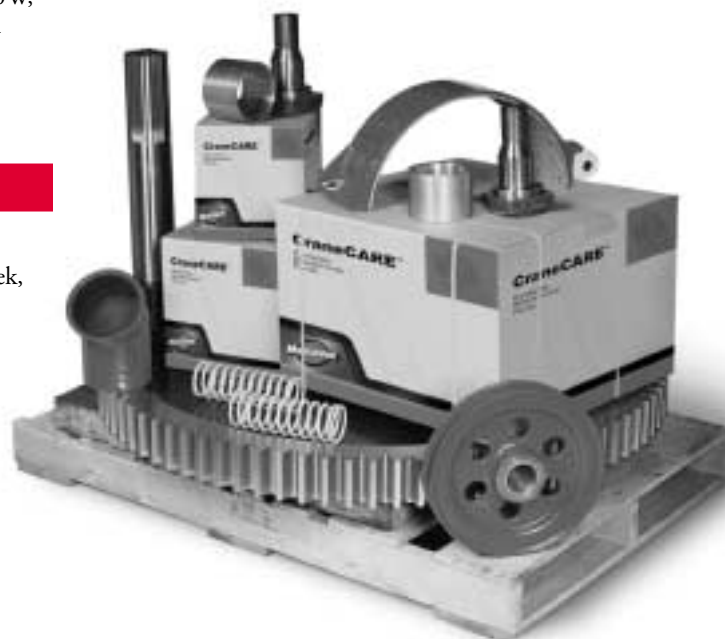

model 111



CraneCARESM

22

Field Service

Factory-trained service experts are always ready to help maintain your crane's peak performance.

For a worldwide listing of dealer locations, please consult our website at: www.manitowoccranes.com

Technical Support

Manitowoc's dealer network and factory personnel are available 24 hours a day, 7 days a week, 365 days a year to answer your technical questions and more, with the help of computerized programs that simplify crane selection, lift planning, and ground-bearing calculations.

For a worldwide listing of dealer locations, please consult our website at: www.manitowoccranes.com

Technical Documentation

Manitowoc has the industry's most extensive documentation, and the easiest to understand, available in major languages and formats that include print, disk, and videotape.

A complete set of Operator's, Parts, Capacity, Vendor, and Service Technician's Manuals are shipped with each crane.

Additional copies available through your Authorized Manitowoc Distributor.

- **Crane Operator's Manual – Part No. 899721**
- **Crane Parts Manual – Part No. 899720**
- **Crane Capacity Manual – Part No. 899730**
- **Crane Vendor Manual – Part No. 899722**
- **Service Technician's Manual (EPIC) – Part No. 899732**

CD rom versions of the Operator's and Parts Manuals are shipped with each crane.

Also available are the following CDs:

- **111 Maintenance Operation Service Parts (MOPS) CD – Part No. 899799-0**
- **Ground Bearing Pressure Estimator CD – Part No. 899765-0**
- **Crane Selection and Planning Software (CompuCRANE®) CD – Part No. 899766-0**
- **Capacity Chart (all EPIC models) CD – Part No. 899801-0**
- **Manitowoc Electronic Sales Assistant (MESA) CD – Part No. 899798-0**

Available from your Authorized Manitowoc Cranes Distributor, these VHS videos are available in NTSC, PAL and SECAM formats.

- **Model 111 Assembly Video – Part No. 899811**
- **Model 111 Operation Video – Part No. 899812**
- **Model 111 Lubrication Video – Part No. 899813**
- **Your Capacity Chart Video – Part No. 899737**
- **Respect the Limits Video – Part No. 899734**
- **Crane Safety Video – Part No. 899736**
- **Boom Inspection/Repair Video – Part No. 899738**



model 111



notes

A large rectangular area filled with a fine grid pattern, intended for handwritten notes.



Backed by Manitowoc

CraneCARESM

CraneCARE is Manitowoc's comprehensive service and support program. It includes classroom and on-site training, prompt parts availability, expert field service, technical support and documentation — for every one of the more than 7,000 Manitowoc cranes currently in use throughout the world. That's commitment you won't find anywhere else. That's CraneCARE.



Manitowoc Cranes, Inc.
P.O. Box 70
Manitowoc, WI, USA 54221-0070
Telephone 920-684-6621
Facsimile 920-683-6277
www.manitowoccranes.com

Bigge Crane and Rigging Co.

10700 Bigge Avenue
San Leandro, CA 94577
Phone: (888) 337-BIGGE or (510) 638-8100
Fax: (510) 639-4053
Email: info@bigge.com
Web site: www.bigge.com

