



model 8000

product guide

- 80 ton Lift Capacity
- 2,037 ft-kips
Maximum Load Moment
- 200' Heavy-Lift Boom
- 240' Fixed Jib
on Heavy-Lift Boom
- 213 HP engine
- 525 fpm line speed
- 32,000 lb Maximum Line Pull
- 16,000 lb Material Rehandling
Clamshell capacity
- Fast, efficient self-assembly
and disassembly
- Manitowoc Crane CARE
comprehensive support



contents

Specifications	3
Outline Dimensions	6
Self Assembly	10
Winch Performance Data	11
Boom Combinations	12
Main Boom Range / Load Charts	13
Fixed Jib Range / Load Charts	16
Clamshell	19



Above. Beyond. Everywhere.™

2

 model 8000



specifications

Upperworks

Engine

Mitsubishi 6D16-TLA2B Diesel, 6 cylinder, water-cooled diesel, direct fuel injection with turbocharger, 159 kW (213 HP) @ 2000 high-idle RPM. Maximum torque 593 lb-ft (804 N·m) net at 1,600 rpm (SAE J 1349).

One diesel fuel tank, 106 gallons (400 liters).
Two 12 volt 120 AH capacity batteries, 24 volt system and 80 amp alternator.

All wiring harnesses and connectors are numbered for easier servicing. Machine is equipped with individual fused branch circuits.

Controls

Full-flow hydraulic control system for constant variable pressure to front and rear drums, boom hoist brakes and clutches. Controls respond instantly to the touch, delivering smooth function operation.

Relief valve pressures:
Load hoist, boom hoist and propel system 4,480 psi (315 kg/cm²)
Swing system 3,980 psi (280 kg/cm²)
Control system 1,140 psi (80 kg/cm²)

Hydraulic System

All three variable displacement piston-type pumps are driven by a heavy-duty pump drive. One of these pumps is used in the right propel circuit and hook hoist circuit, and can accommodate an optional third circuit. Another is used in the left propel circuit, boom hoist circuit and hook hoist circuit. The third variable displacement pump is used in the swing circuit. In addition, two gear pumps are used in the control system and auxiliary equipment. One of these serves the clutch and brakes. Also, two gear pumps are utilized in the brake cooling system.

Maximum pressure rating 4,640 psi (325 kg/cm²)

Load hoist, boom hoist and propel ... 2 Piston pumps
Swing 1 Piston pump
Control system and auxiliary 2 Gear pumps
Brake cooling system 2 Gear pumps

Reservoir capacity: 100 US gallon (380 liter).

Cooling: Oil-to-air heat exchanger (plate-fin type).

Filtration: Full-flow and bypass type with replaceable paper element.

Drums

3

Front and rear drums for load hoist powered by hydraulic variable displacement piston-type motors, driven through planetary reducers. Powered hoisting/lowering and free-fall operation is standard. Drum turn indicators for front and rear drums are also standard.

Brake: spring set, hydraulically-released, multiple-disc holding brake is mounted inside the hoist motor and is operated through a counter-balance valve. An external ratchet is fitted for locking the drums.

Drums: front and rear 21.7" (550,2 mm) P.C.D. X 21.5" (545.4 mm), grooved for 7/8" (2,2 mm) wire rope.

Wire rope capacity:
 Front drum 869 ft (265 m) working length
 Rear drum 673 ft (205 m) working length
 Storage length (each drum) 1,099' (335 m)

Line speed: Single line on the first drum layer
Hoisting 390 ft/min (120m/min)
Lowering 390 ft/min (120m/min)

Optional third drum: same dimensions and specifications as front drum.

Swing System

Swing unit: Powered by a hydraulic piston-type motor driving spur gears through planetary reducers, the swing system provides 360° rotation.

Swing brake: A spring-set, hydraulically released multiple-disc brake is internally fitted in swing motor.

Swing lock: 2 Position lock for transportation.

Rotating bed turntable: Single-row ball bearing with an integral internally cut swing gear.

Swing speed 4.0 rpm

Boom Support System

Single drum powered by a hydraulic axial piston motor through a planetary reducer.

Brake: A spring-set, hydraulically released multiple-disc brake is internally fitted in the boom hoist motor and operated through a counter-balance valve. An external ratchet is fitted for locking the drums.

model 8000

specifications



Boom Support System

4 This high folding type gantry is fitted with a sheave frame for boom hoist reeving. Hydraulic lift is standard. It provides full up, full down positions with linkage.



Counterweight

QTY.	ITEM	UNIT WEIGHT		TOTAL WEIGHT	
		kg	lb	kg	lb
2	Carbody Each	3 340	7,350	6 680	14,700
Carbody Total				6 680	14,700
1	Upperworks Counterweight A	12 500	27,563	12 500	27,560
1	Counterweight B	12 400	27,342	12 400	27,340
Upperworks Total				24 900	54,900
Counterweight TOTAL				31 580	69,600



Operator's Cab

Totally enclosed, full vision cab fitted with tinted safety glass and a sliding front window. A fully adjustable, highbacked seat with arm rests permits operators to set their ideal working position. Side mounted console for auxiliary controls and instruments. An air conditioner, a signal horn, cigarette lighter, windshield wiper and inspection lamp socket are standard features.

Controls

In front of operator are the foot pedals for front and rear drum brakes and foot acceleration pedal. At operator's right side are the travel (propel) control levers and the function lock lever. To the operator's right front are the boom hoist control lever, main (front) and auxiliary (rear) winch control levers and the free-fall select switches for the main and auxiliary winches and drum turn indicator (front/rear drum). To the operators left front are the swing control lever and third drum control lever (if the machine is so equipped). To the operator's left are the crawler extend/retract lever and the positive swing lock. The left-hand console contains toggle switches for travel (propel) speed, free-fall high/low select, gantry control, crane/clamshell select switch and the anti-two-block/boom overhoist switches. Directly in front of the console are the drum pawl lock for boom, front, rear and third drum (if so equipped) and the engine ignition key. The swing brake and signal horn are mounted on the swing control lever.

Gauges

Fuel gauge, engine water temperature gauge, hour meter and tachometer are located on the monitor display.

Warning display

All potential warnings, including battery charge, engine oil pressure, air cleaner, engine oil filter, control main pressure, and hydraulic oil temperature will appear on the monitor display when a fault occurs.

Safety device

Function lock lever, anti-two-block, boom over hoist limit switch, boom angle indicator, signal horn, boom hoist drum lock, front and rear drum lock, swing lock, swing alarm (buzzer and lamps), boom backstops, safety latch on hook blocks, and load moment indicator.

Lowerworks



Carbody

The durable carbody features steel welded construction with extendible axles.



Crawlers

Crawler assemblies can be hydraulically extended for wide-track operation or retracted for transportation. Crawler belt tension adjusted with hydraulic jack and maintained by shims between idler block and frame.

Crawler drive

The independent hydraulic propel drive is built into each crawler side frame. Each drive consists of a hydraulic motor driving a propel sprocket through a planetary gearbox. The hydraulic motor and gearbox are built into the crawler side frame within the shoe width. The track rollers are sealed for maintenance-free operation.

Crawler brakes

Spring set, hydraulically released, multiple disc-type parking brakes are built into each propel drive.

Steering mechanism

The hydraulic propel system provides both skid steering (driving one track only) and counter-rotating steering (driving each track in opposite direction).

Crawler shoes

63 shoes, 36" (914 mm) wide each crawler.

Travel speed

(High/Low) 1.18/0.75 mph (1,9/1,2 km/h)

model 8000



specifications

5

Attachments



Boom

Welded lattice construction using tubular, high-tensile steel chords with pin connections between sections. Boom tip is open throat construction. Two idler sheaves and four point sheaves are standard.

Basic boom length 50' (15,2 m) consists of the boom butt section 19' 0" (5,80 m), 10' 0" (3,0 m) boom insert and boom top section 21' 0" (6,39 m) and .

Optional boom inserts are available to provide extension capabilities. They also have welded lattice construction with tubular, high-tension steel chords and pin connections on each one of 10' (3,05 m), 20' (6,10 m), 40' (12,2 m) inserts.

Maximum total length of boom 200' (61,0 m).



Fixed Jib

The optional fixed jib employs welded lattice construction with tubular, high-tension steel chords with pin connections between sections.

Basic jib length 30' (9,14 m) consists of Jib butt section 15' (4,57 m) and Jib top section 15' (4,57 m).

Optional Jib boom inserts of 10' (3,05 m), 20' (6,10 m) are available for extension capabilities up to 60' (18,3 m).

Maximum total length of boom and jib 180' (57,9 m) + 60' (18,3 m) is 240' (73,2 m).

Tools and Accessories

A set of tools and accessories are furnished.

Optional Equipment

- ▶ **Optional: Blocks and Hooks**
- ▶ 12 US ton ball hook, 396 lbs.
- ▶ 60 US ton hook block, 2,398 lbs, four 24" Nom. OD roller bearing sheaves grooved for 7/8" dia. wire rope, and roller bearing swivel with hook latch.

Travel kit
Detachable upper boom point
Custom color

model 8000



outline dimensions

6

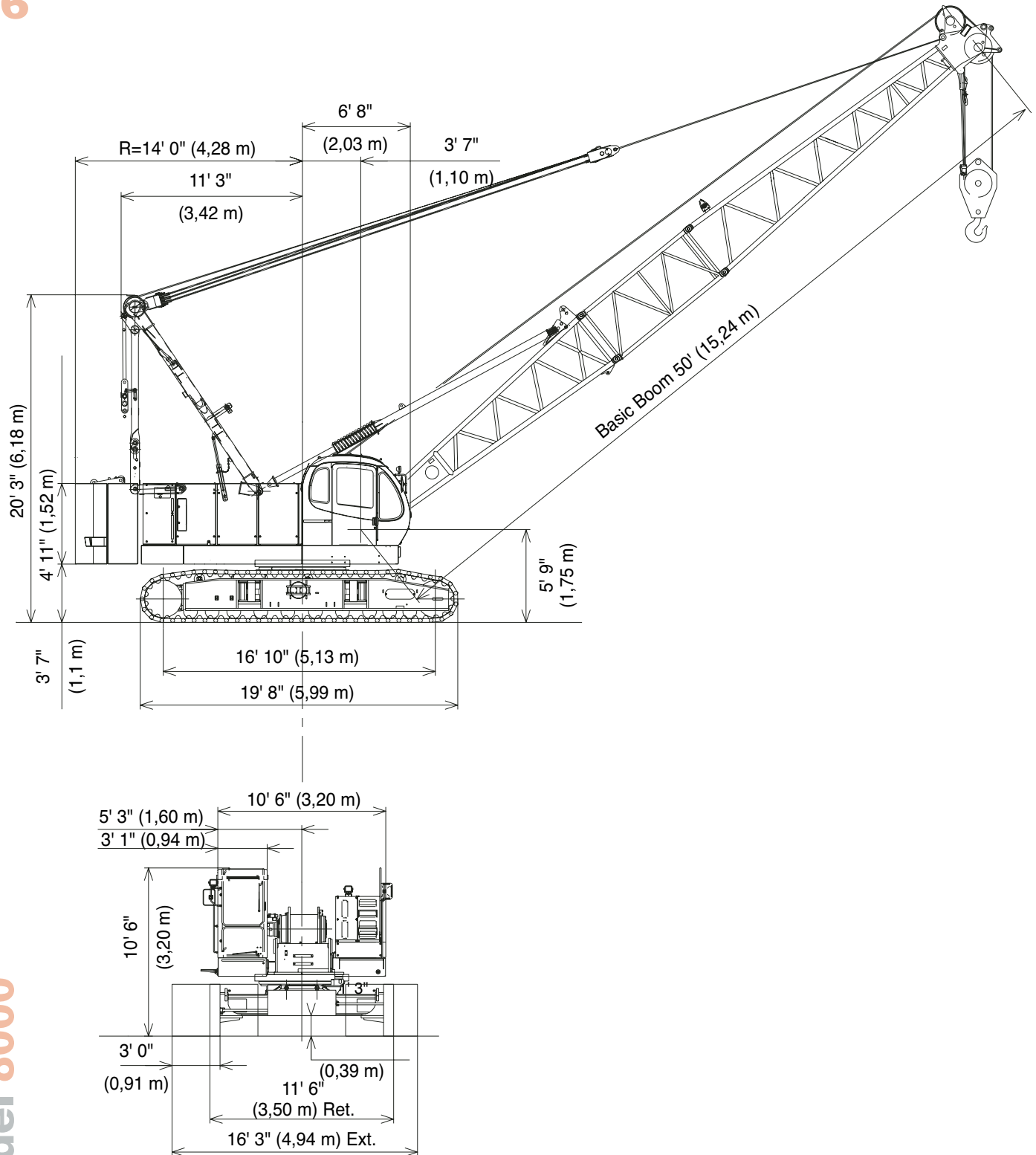

model 8000



outline dimensions

7

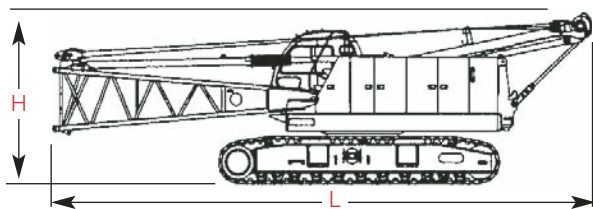

Upperworks x 1

Length	12,16 m	39' 11"
Width	3,50 m	11' 6"
Height	3,45 m	11' 4"
Weight	40 820 kg	89,980 lb

Note: Weight includes base machine, crawler, gantry, maximum hoist and whip lines on drums, boom butt, full hydraulic fluid reservoir, and half tank of fuel.

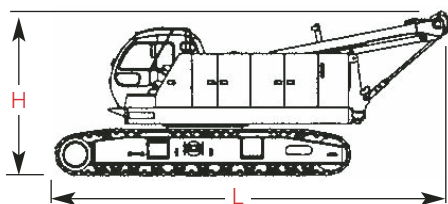

Upperworks x 1

Length	8,27 m	27' 2"
Width	3,50 m	11' 6"
Height	3,45 m	11' 4"
Weight	38 700 kg	85,350 lb

Note: Weight includes base machine, crawler, gantry, maximum hoist and whip lines on drums, full hydraulic fluid reservoir, and half tank of fuel.

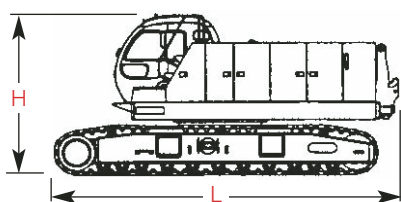

Upperworks x 1

Length	6,55 m	21' 6"
Width	3,50 m	11' 6"
Height	3,20 m	10' 6"
Weight	37 000 kg	81,600 lb

Note: Weight includes base machine, crawler, maximum hoist and whip lines on drums, full hydraulic fluid reservoir, and half tank of fuel.

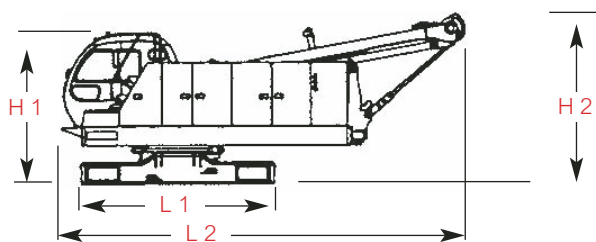

Upperworks x 1

Length 1	3,39 m	11' 1"
Length 2	6,31 m	23' 9"
Width	3,20 m	10' 6"
Height 1	2,81 m	9' 3"
Height 2	3,06 m	10' 1"
Weight	23 800 kg	52,500 lb

Note: Weight includes base machine, gantry, maximum hoist and whip lines on drums, full hydraulic fluid reservoir, and half tank of fuel.

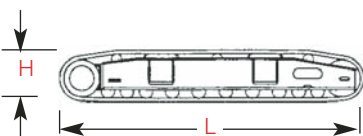

Crawlers x 2

Length	5,99 m	19' 8"
Width	0,91 m	3' 0"
Height	0,98 m	3' 3"
Weight	7 400 kg	16,317 lb

Optional 3rd Drum & Wire Rope x 1

Weight	1 930 kg	4,236 lb
--------	----------	----------

Option

model 8000
Manitowoc

outline dimensions

8

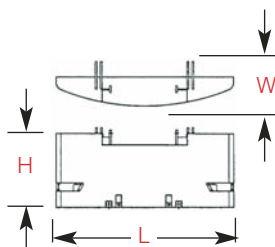

Upper Counterweight A x 1

Length	3,60 m	11' 10"
Width	0,91 m	3' 0"
Height	1,64 m	5' 5"
Weight	12 500 kg	27,563 lb

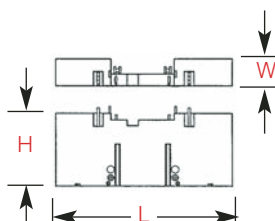

Upper Counterweight B x 1

Length	3,60 m	11' 10"
Width	0,57 m	1' 10"
Height	1,67 m	5' 6"
Weight	12 400 kg	27,342 lb

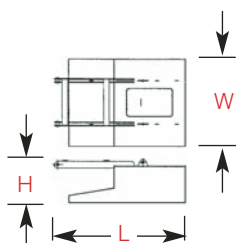

Carbody Counterweight x 2

Length	1,72 m	5' 8"
Width	1,16 m	3' 10"
Height	0,58 m	1' 11"
Weight	3 340 kg	7,350 lb

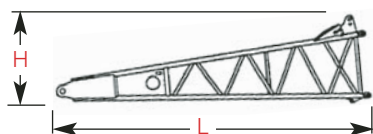

Boom Butt 5,8 m (19') x 1

Length	5,97 m	19' 7"
Width	1,42 m	4' 8"
Height	1,48 m	4' 10"
Weight	1 055 kg	2,326 lb

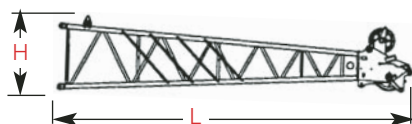

Boom Top 6,4 m (21') x 1

Length	6,90 m	22' 8"
Width	1,38 m	4' 6"
Height	1,48 m	4' 10"
Weight	1 010 kg	2,227 lb

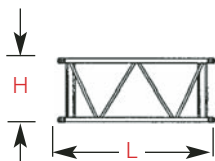

Boom Insert 3,0 m (10') x 1, 2

Length	3,16 m	10' 4"
Width	1,36 m	4' 6"
Height	1,29 m	4' 3"
Weight	270 kg	590 lb

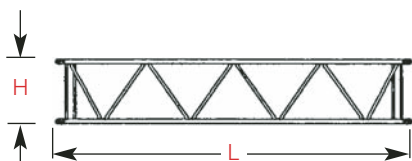

Boom Insert 6,1 m (20') x 1, 2

Length	6,21 m	20' 5"
Width	1,36 m	4' 6"
Height	1,29 m	4' 3"
Weight	465 kg	1,025 lb

Option

model 8000

outline dimensions

9

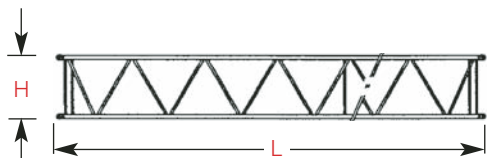

Boom Insert 12,2 m (40')	x 1, 2, 3	
Length	12,31 m	40' 5"
Width	1,36 m	4' 6"
Height	1,29 m	4' 3"
Weight	860 kg	1,896 lb
Weight A	875 kg	1,929 lb

Note: Use one "A" type insert with lug required for any boom combinations that require a 12,2 m (40') insert.

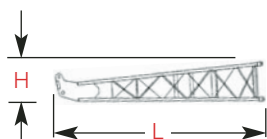

Fixed Jib Butt	x 1	
Length	4,82 m	15' 9"
Width	0,79 m	2' 7"
Height	0,79 m	2' 7"
Weight	200 kg	441 lb

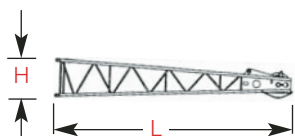

Fixed Jib Top	x 1	
Length	4,96 m	16' 3"
Width	0,79 m	2' 7"
Height	0,79 m	2' 7"
Weight	280 kg	617 lb

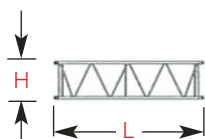

Fixed Jib Insert 3,0 m (10')	x 1	
Length	3,12 m	10' 3"
Width	0,79 m	2' 7"
Height	0,79 m	2' 7"
Weight	100 kg	221 lb

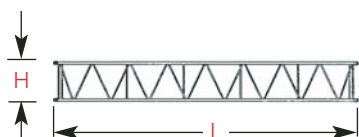

Fixed Jib Insert 6,1 m (20')	x 1	
Length	6,16 m	20' 3"
Width	0,79 m	2' 7"
Height	0,79 m	2' 7"
Weight	180 kg	397 lb

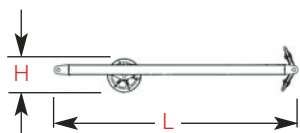

Fixed Jib Strut	x 1	
Length	3,62 m	11' 11"
Width	0,84 m	2' 9"
Height	0,50 m	1' 8"
Weight	205 kg	452 lb

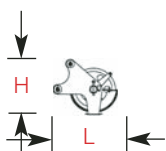

Upper Sheave	x 1	
Length	0,83 m	2' 9"
Width	0,28 m	1' 0"
Height	0,74 m	2' 5"
Weight	145 kg	320 lb

Option

model 8000



self assembly

10

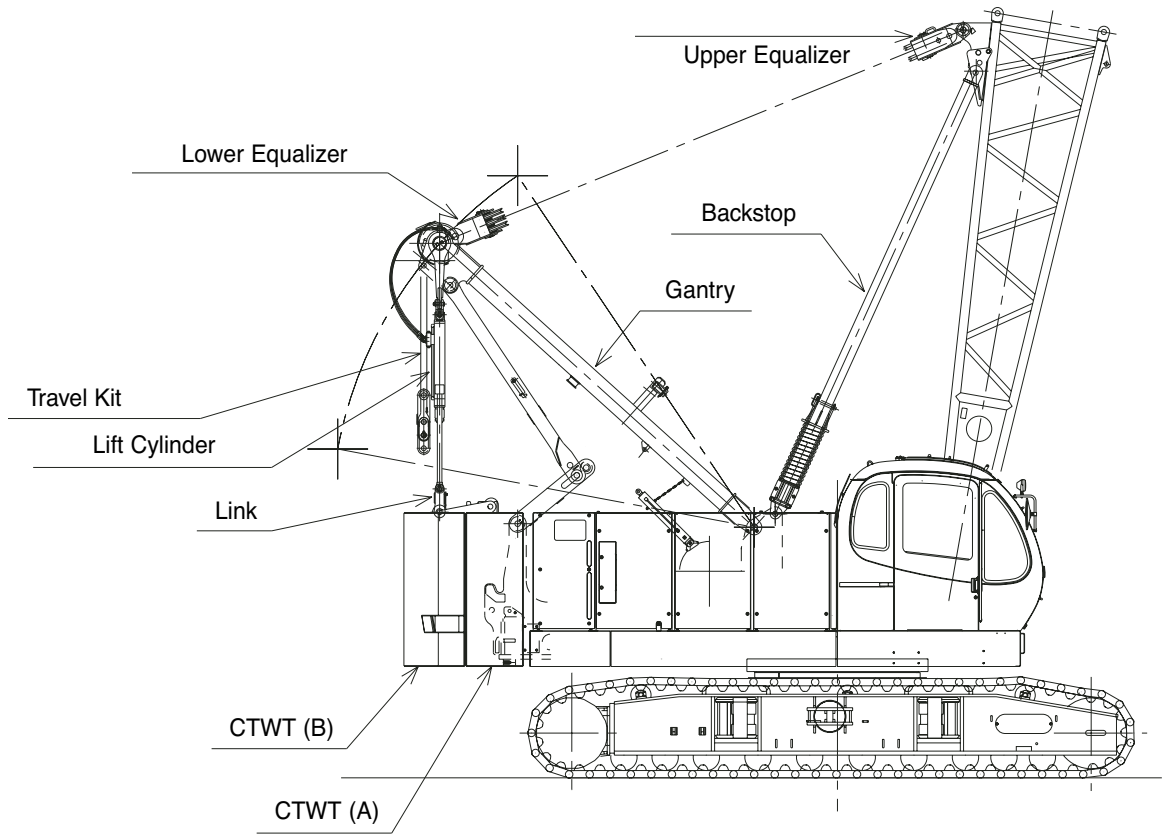

model 8000
Manitowoc

winch performance data

Line Pull

	Rated line pull	*Maximum line pull
Front Drum	17,000 lbs (7 700 kg)	32,000 lbs (14 500 kg)
Rear Drum	17,000 lbs (7 700 kg)	32,000 lbs (14 500 kg)
Optional 3rd Drum	17,000 lbs (7 700 kg)	32,000 lbs (14 500 kg)

* Maximum line pull is not based on wire rope strength.

11

Wire Rope Specifications

Use	Specs	Diameter inch (mm)	Working Length feet (m)	Breaking Strength lbs (kg)
Front Drum	IWRC C/O 6 X Fi (25)	7/8" (22,2)	869' (265)	79,586 (36 100)
Rear Drum	IWRC C/O 6 X Fi (25)	7/8" (22,2)	673' (205)	79,586 (36 100)
Boom Hoist Drum	IWRC O/O 6 X WS (31)	5/8" (15,8)	492' (150)	41,234 (18 700)
Opt. Third Drum	IWRC C/O 6 X Fi (25)	7/8" (22,2)	869' (265)	79,586 (36 100)

Model 8000 Front and Rear Winch Performance (Optional: Third Winch)

		Line speed (ft/min)					
Layer		1	2	3	4	5	6
Line Pull (lbs)							
	0	394	420	446	472	499	525
	5,000	397	420	446	472	499	525
	10,000	353	353	353	353	353	353
	15,000	235	235	235	235	235	235
Rated Line pull	17,000	208	208	208	208	208	208
	20,000	176	176	176	176	179	182
	25,000	141	146	148	149	149	
	30,000	123					

		Line speed (m/min)					
Layer		1	2	3	4	5	6
Line Pull (kgf)							
	0	120	128	136	144	152	160
	2,268	121	128	136	144	152	160
	4,536	108	108	108	108	108	108
	6,804	72	72	72	72	72	72
Rated Line pull	7,711	63	63	63	63	63	63
	9,072	54	54	54	54	55	56
	11,340	43	44	45	45	45	
	13,608	38					

Note:
Line speeds and line pull based on single line.
Line pulls are not based on wire rope strength.



boom combinations

12

No. 8000 Heavy-Lift Boom Combinations

Boom Length m (ft)	Boom Inserts		
	3,1 m (10 ft)	6,1 m (20 ft)	12,2 m (40 ft)
15,2 (50)	1	-	-
18,3 (60)	-	1	-
21,3 (70)	1	1	-
24,4 (80)	-	-	1*
27,4 (90)	1	-	1*
30,5 (100)	-	1	1*
33,5 (110)	1	1	1*
36,6 (120)	-	-	2*
39,6 (130)	1	-	2*
42,7 (140)	-	1	2*
45,7 (150)	1	1	2*
48,8 (160)	-	-	3*
51,8 (170)	1	-	3*
54,9 (180)	-	1	3*
57,9 (190)	1	1	3*
61,0 (200)	2	1	3*

*Note: One 40 ft. (12,2 m) boom insert with lug 40A (12,20 m) is required for crane jib. When no jib is available, a 40 ft (12,2 m) boom can be used instead of 40A (12,2 m).

Fixed Jib Combinations

Jib Length m (ft)	Fixed Jib Inserts	
	3,1 m (10 ft)	6,1 m (20 ft)
9,1 (30)	-	-
12,2 (40)	1	-
15,2 (50)	-	1
18,3 (60)	1	1

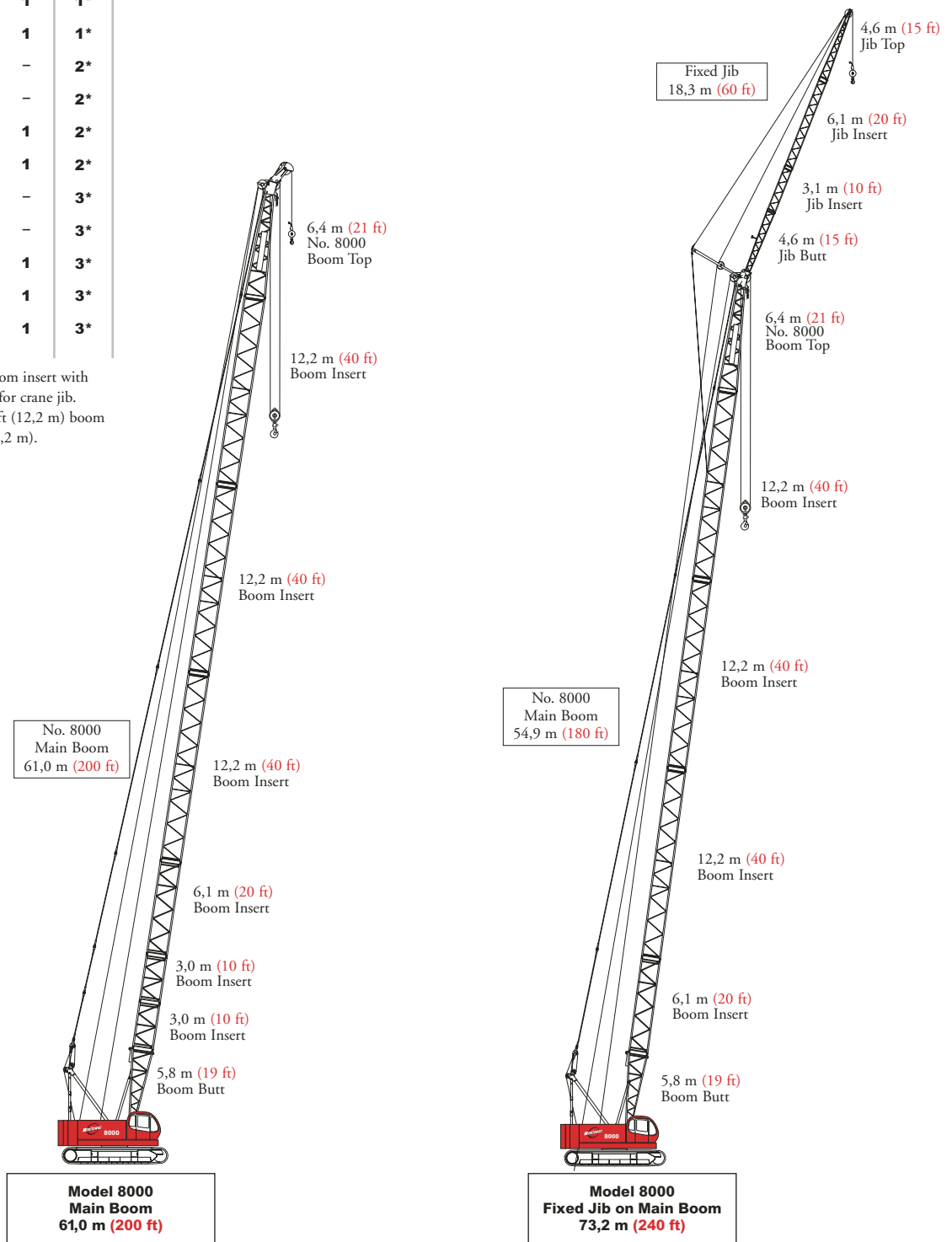

model 8000

load chart notes

13

- Rated loads included in the charts are the maximum allowable freely suspended loads at a given boom length, boom angle and load radius, and have been determined for the machine standing level on firm supporting surface under ideal operating conditions. The user must limit or de-rate rated loads to allow for adverse conditions (such as soft or uneven ground, out-of-level conditions, wind, side loads, pendulum action, jerking or sudden stopping of loads, inexperience of personnel, multiple machine lifts, and traveling with a load).
- Capacities do not exceed 75% of minimum tipping loads. Capacities based on factors other than machine stability such as structural competence are shown by asterisk * in the charts.
- The machine must be reeved and set-up as stated in the operation manual and all the instruction manuals if these manuals are missing, obtain replacements. Boom backstops are required for all boom lengths. Gantry must be fully raised position for all operations. Crawlers must be fully extended and be locked in position. The crane must be leveled to within 1% on a firm supporting surface.
- Do not attempt to lift where no radius or load is listed as crane may tip or collapse.
- Attempting to lift more than rated loads may cause machine to tip or collapse. Do not tip machine to determine capacity.
- Weight of hooks, hook blocks, slings and other lifting devices are a part of the total load. Their total weight must be subtracted from the rated load to obtain the weight that can be lifted.
- When lifting over boom point with jib or auxiliary sheave installed, rated loads for the boom must be deducted as shown below.

Jib length	Aux. Sheave	30'	40'	50'	60'
Deduct (lbs)	320	2,400	3,200	4,200	5,200

- The total load that can be lifted by the jib is limited by rated jib loads.
- Boom lengths for jib mounting are 80 ft (24,4 m) to 180 ft (54,9 m)
- The total load that can be lifted by the auxiliary sheave is: the rated load for the boom (without auxiliary sheave installed) minus 320 lbs; however, the auxiliary sheave rated load should not exceed 17,000 lbs.

- An auxiliary sheave cannot be used on a 200 ft (60.96 m) boom length.
- The boom should be erected over the front of the crawlers, not laterally. When erecting and lowering the boom with a length of 180 ft (54,9 m) with jib, blocking must be placed at the end of the crawlers. See operator's manual for details.
- Least stable position is over the side.
- Maximum hoist load for number of reeving parts of line for hoist rope.

Maximum Load for Main Boom

No. of Parts of Line	1	2	3	4	5
Maximum Loads (lbs)	17,000	34,000	51,000	68,000	85,000

No. of Parts of Line	6	7	8	9	10
Maximum Loads (lbs)	102,000	119,000	136,000	153,000	160,000

Maximum Load for Fixed Jib

No. of Parts of Line	1	2
Maximum Loads (lbs)	17,000	24,000

Maximum Load for Auxiliary Sheave

No. of Parts of Line	1
Maximum Loads (lbs)	17,000

- Lifting capacities listed apply only to the machine as originally manufactured for and supplied by Manitowoc Cranes, Inc. Modifications to this machine or use of equipment other than that specified can reduce operating capacity.
- Designed and rated to comply with ANSI Code B30.5.

Operation of this equipment in excess of rated loads or disregard of instruction voids the warranty.

model 8000

heavy-lift boom range diagram

No. 8000 Main Boom

14

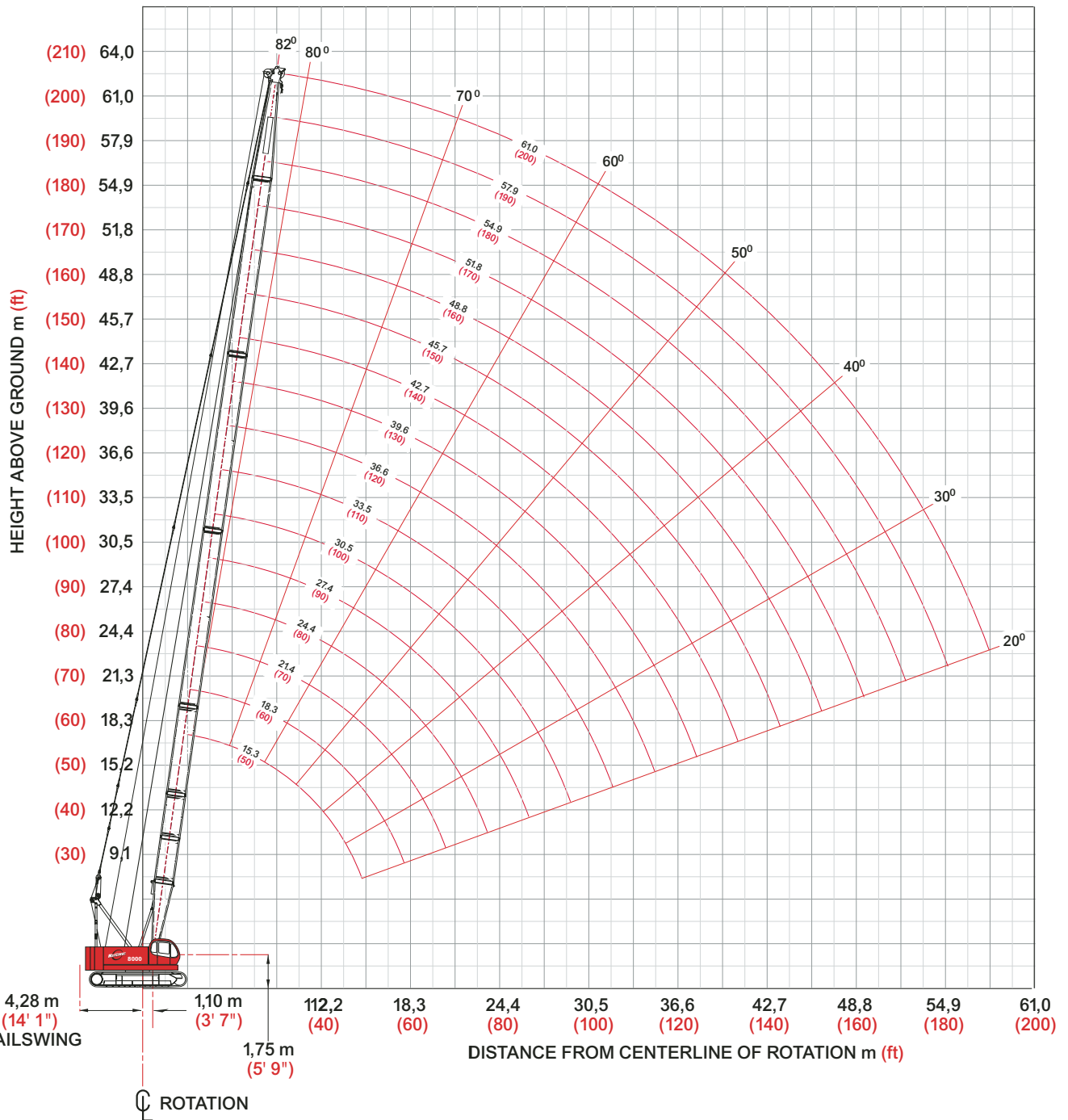

model 8000



heavy-lift load charts

Liftcrane Boom Capacities No. 8000 Main Boom

69,600 lb Counterweight

360° Rating

lb x 1 000

15

Boom ft	50	60	80	100	120	140	160	180	190	200
Radius										
10										
12	160.0									
14	144.0	143.8								
16	126.9	126.7	126.3							
18	113.2	113.0	112.6							
20	97.4	97.1	96.9	96.8						
24	73.8	73.6	73.3	73.1	73.0	61.7				
28	59.2	58.9	58.7	58.4	58.3	57.9	44.0			
34	45.5	45.2	44.8	44.5	44.3	44.0	42.1	32.6	28.8	25.7
40	36.8	36.4	36.0	35.7	35.4	35.1	34.9	31.0	27.5	24.4
45	31.6	31.2	30.8	30.5	30.2	29.9	29.7	29.2	26.4	23.3
55		24.2	23.7	23.3	23.0	22.6	22.4	22.0	22.1	21.3
75			15.9	15.4	15.0	14.6	14.3	13.9	13.9	13.7
95				11.2	10.7	10.2	10.0	9.5	9.5	9.3
105					9.2	8.7	8.5	8.0	8.0	7.8
115					8.1	7.6	7.2	6.7	6.8	6.5
125						6.6	6.2	5.7	5.7	5.4
135						5.9	5.4	4.7	4.8	4.5
145							4.7	4.0	4.0	3.7
155								3.3	3.3	3.0
170								2.6	2.5	

model 8000



Meets ANSI B30.5 Requirements - Capacities do not exceed 75% of static tipping load.
NOTICE: This capacity chart is for reference only and must not be used for lifting purposes.



fixed jib range diagram

No. 8000 Fixed Jib on Main Boom

16

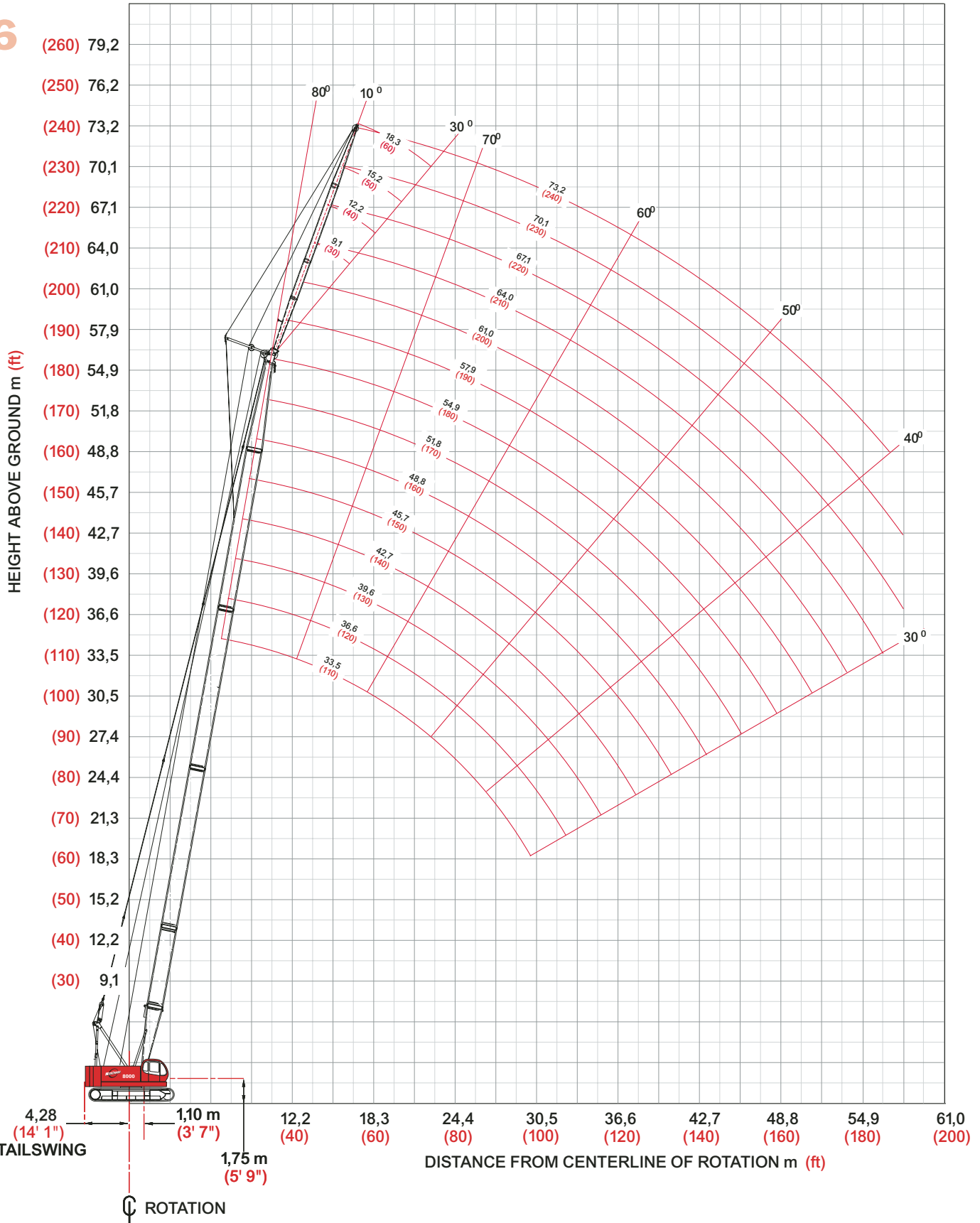

fixed jib load charts

Liftcrane Jib Capacities Fixed Jib on No. 8000 Main Boom

69,600 lb Counterweight

360° Rating

lb x 1 000

17

		10° Offset				
Boom ft		80	100	130	160	180
Jib 30 ft	Radius					
	30	24.0				
	40	24.0	24.0	24.0		
	50	24.0	24.0	24.0	24.0	19.7
	60	21.3	20.8	20.3	19.7	18.7
	80	14.4	13.9	13.3	12.7	12.3
	100	10.6	10.0	9.4	8.8	8.3
	120			6.9	6.2	5.8
	140			5.2	4.4	3.7
	150				3.6	2.9
160				2.9		
170						

		30° Offset				
Boom ft		80	100	130	160	180
Jib 30 ft	Radius					
	30					
	40	19.7				
	50	17.6	18.5	19.6		
	60	15.9	16.9	18.0	18.9	18.5
	80	13.7	14.3	13.7	13.2	12.9
	100			9.7	9.1	8.7
	120				6.5	6.1
	140					4.0
	150					
160						
170						

		10° Offset				
Boom ft		80	100	130	160	180
Jib 40 ft	Radius					
	30					
	40	24.0	24.0			
	50	22.1	24.0	24.0	22.8	
	60	18.8	20.9	20.5	20.3	17.8
	80	14.5	14.1	13.5	12.9	12.5
	100	10.7	10.2	9.5	8.9	8.5
	120		7.6	7.0	6.4	5.9
	140			5.2	4.5	3.9
	150			4.6	3.7	3.1
160				3.0		
170						

		30° Offset				
Boom ft		80	100	130	160	180
Jib 40 ft	Radius					
	30					
	40					
	50	14.4	15.1			
	60	12.9	13.6	14.5	15.1	
	80	10.9	11.6	12.5	13.2	13.5
	100		10.3	10.0	9.6	9.3
	120			7.4	6.9	6.5
	140				5.0	4.5
	150					3.6
160						
170						

Meets ANSI B30.5 Requirements - Capacities do not exceed 75% of static tipping load.
NOTICE: This capacity chart is for reference only and must not be used for lifting purposes.



fixed jib load charts

18

Liftcrane Jib Capacities Fixed Jib on Main Boom

69,600 lb Counterweight

360° Rating

lb x 1 000

		10° Offset					30° Offset						
Boom ft		80	100	130	160	180	Boom ft		80	100	130	160	180
Jib 50 ft	Radius												
	30												
	40	20.0	20.0										
	50	18.5	20.0	20.0									
	60	15.6	17.2	19.3	19.2	17.0							
	80	12.0	13.3	13.6	13.1	12.7							
	100	9.7	10.3	9.7	9.1	8.7							
	120	8.6	7.7	7.1	6.5	6.0							
	140			5.7	4.6	4.0							
	150			4.6	3.1	3.2							
160			4.0										
170													

		10° Offset					30° Offset						
Boom ft		80	100	130	160	180	Boom ft		80	100	130	160	180
Jib 60 ft	Radius												
	30												
	40	18.0											
	50	16.3	17.6	18.0									
	60	13.7	15.0	16.7	17.8	15.0							
	80	10.4	11.5	13.0	13.2	12.8							
	100	8.3	9.3	9.7	9.1	8.7							
	120	7.0	7.8	7.1	6.5	6.1							
	140		6.0	5.4	4.7	4.1							
	150			4.7	3.9	3.3							
160			4.0	3.1	2.5								
170			3.4	2.5									

model 8000



Meets ANSI B30.5 Requirements - Capacities do not exceed 75% of static tipping load.
NOTICE: This capacity chart is for reference only and must not be used for lifting purposes.

clamshell

19

Boom:

Welded lattice construction using tubular, high-tensile steel chords with pin connections between sections.
 Basic boom length: 40 ft (12.2 m)
 Max. boom length: 70 ft (21.3 m)
 Limit on clamshell bucket weight: 4,600 lbs (2,100 kg)

Boom Component Chart

Boom length ft (m)	Boom arrangement
50 (15.2)	Base-A-Tip
60 (18.3)	Base-A-A-Tip, Base-B-Tip
70 (21.3)	Base-A-B-Tip

Base = 20 ft (6.10 m)
 Insert: A = 10 ft (3.05 m)
 B = 20 ft (6.10 m)
 Tip = 20 ft (6.10 m)

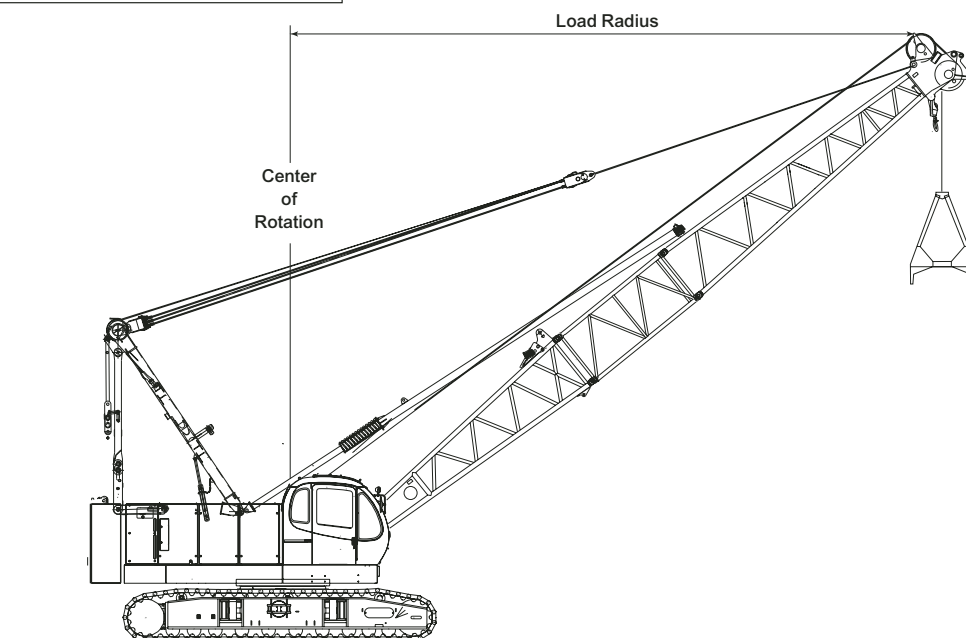

Clamshell Capacities

42,258 lb Counterweight

lb x 1 000

Boom ft	40	50	60	70
Radius				
22	16.0			
26	16.0	16.0		
30	16.0	16.0	16.0	
36	16.0	16.0	16.0	16.0
40	16.0	16.0	16.0	16.0
46		16.0	16.0	16.0
50			14.5	14.3
56			12.3	12.3
60				11.2
66				9.7

model 8000





Manitowoc Crane Group - Americas

Manitowoc, Wisconsin Facility
 Tel: [Int + 001] 920 684 6621
 Fax: [Int + 001] 920 683 6277
 Shady Grove, Pennsylvania Facility
 Tel: [Int + 001] 717 597 8121
 Fax: [Int + 001] 717 597 4062

Manitowoc Crane Group - Latin America

Mexico (Service)
 Tel: [Int + 52] 81 8124 0128
 Fax: [Int + 52] 81 8124 0129

Manitowoc Crane Group - EMEA

Europe Middle East & Africa
 Tel: [Int + 33] (0) 4 72 18 20 20
 Fax: [Int + 33] (0) 4 72 18 20 00

Manitowoc Crane Group - UK

Europe Middle East & Africa (Parts & Service)
 Tel: [Int + 44] (0) 191 565-6281
 Fax: [Int + 44] (0) 191 564-0442

Manitowoc Crane Group - Germany

(Sales, Parts & Service)
 Tel: [Int + 49] (0) 2173 8909-0
 Fax: [Int + 49] (0) 2173 8909-30

Manitowoc Crane Group - France

France & Africa (Sales, Parts & Service)
 Tel: [Int + 33] (0) 1 303-13150
 Fax: [Int + 33] (0) 1 303-86085

Manitowoc Crane Group - Netherlands

(Sales, Parts & Service)
 Tel: [Int + 31] (0) 76 578 39 99
 Fax: [Int + 31] (0) 76 578 39 78

Manitowoc Crane Group - Italy

Italy & Southern Europe (Sales, Parts & Service)
 Tel: [Int + 39] (0) 331 49 33 11
 Fax: [Int + 39] (0) 331 49 33 30

Manitowoc Crane Group - Portugal

Portugal & Spain (Sales, Parts & Service)
 Tel: [Int + 351] (0) 22 968 08 89
 Fax: [Int + 351] (0) 22 968 08 97

Manitowoc Crane Group - Singapore

Asia/Pacific excl China (Sales, Parts & Service)
 Tel: [Int + 65] 6861-7133
 Fax: [Int + 65] 6862-4040 / 4142

Manitowoc Crane Group - Shanghai

China (Sales, Parts & Service)
 Tel: [Int + 86] (0) 21-64955555
 Fax: [Int + 86] (0) 21-64852038

Manitowoc Crane Group - Beijing

China (Sales, Parts & Service)
 Tel: [Int + 86] (0) 10 646-71690
 Fax: [Int + 86] (0) 10 646-71691

Manitowoc Crane Group - Middle East

(Sales)
 Tel: [Int + 971] (0) 4 348-4478
 Fax: [Int + 971] (0) 4 348-4478
 (Parts & Service)
 Tel: [Int + 973] (0) 9 660-899
 Fax: [Int + 973] (0) 2 707-740



www.manitowoccranegroup.com

Bigge Crane and Rigging Co.

10700 Bigge Avenue
 San Leandro, CA 94577
 Phone: (888) 337-BIGGE or (510) 638-8100
 Fax: (510) 639-4053
 Email: info@bigge.com
 Web site: www.bigge.com

