

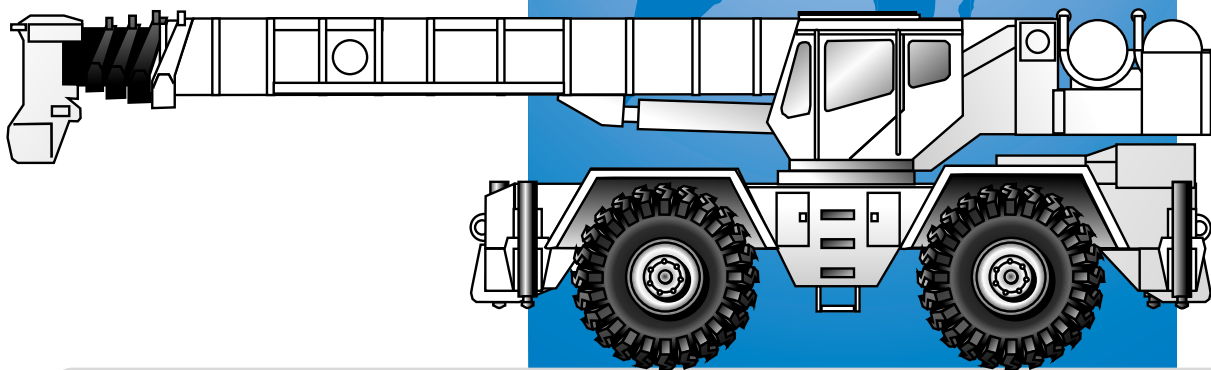

RT865BXL



Rough Terrain Hydraulic Crane



Dimensions

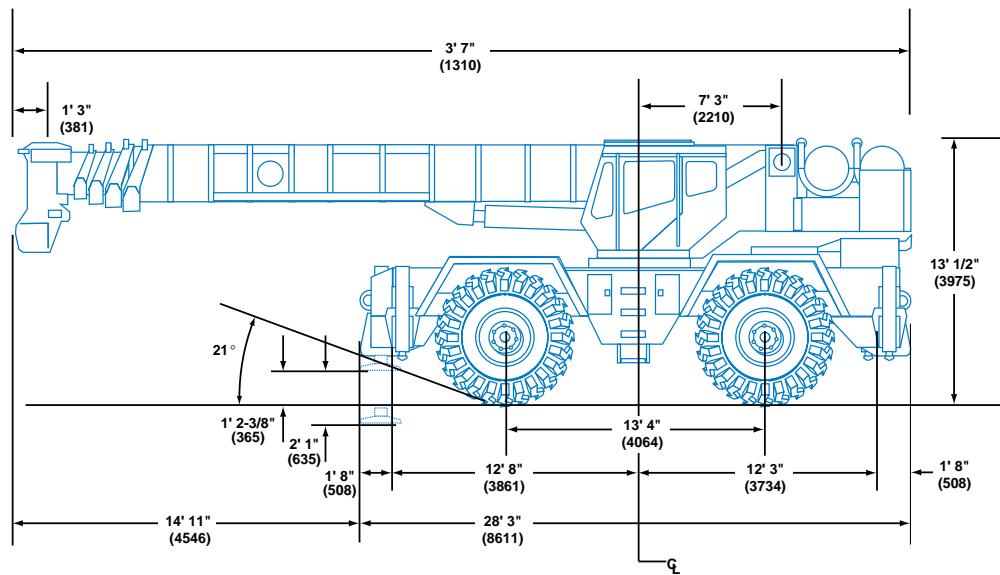
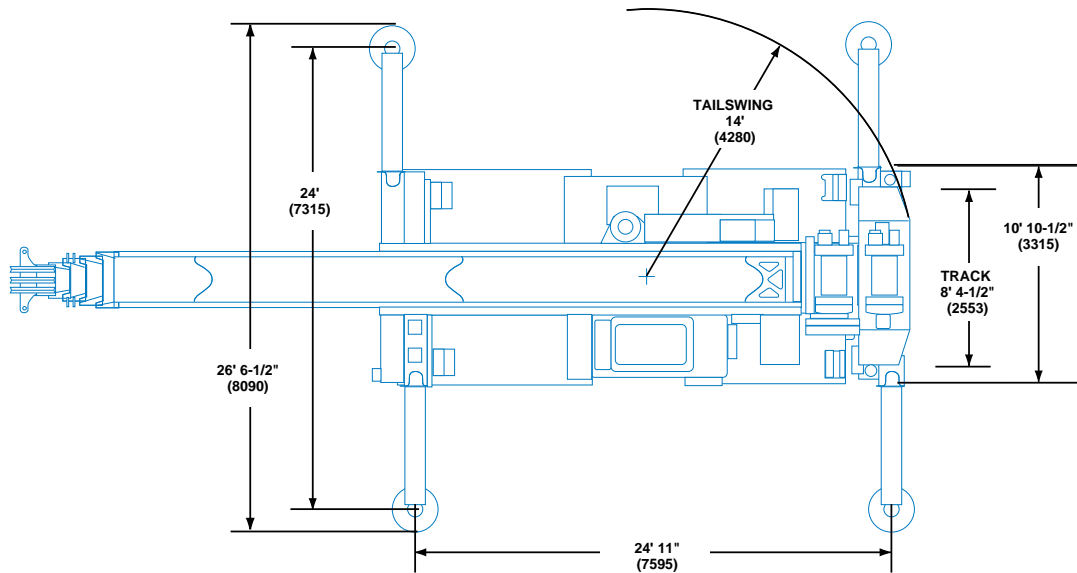

Note: () Reference dimensions in mm

Turning Radius 22' 6" (6858 mm)

Front Axle Load 52,239 lbs. (23 695 kg)

Rear Axle Load 50,601 lbs. (22 953 kg)

Gross Vehicle Weight 102,840 lbs. (46 648 kg)

Working Range



35-138 ft.
(10.6-42 m)

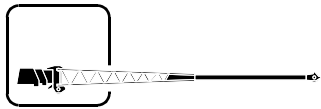

31-56 ft.
(9.4-17 m)

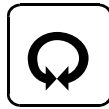
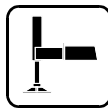

360°

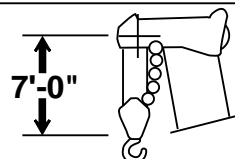
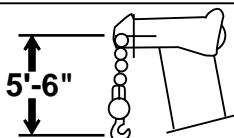
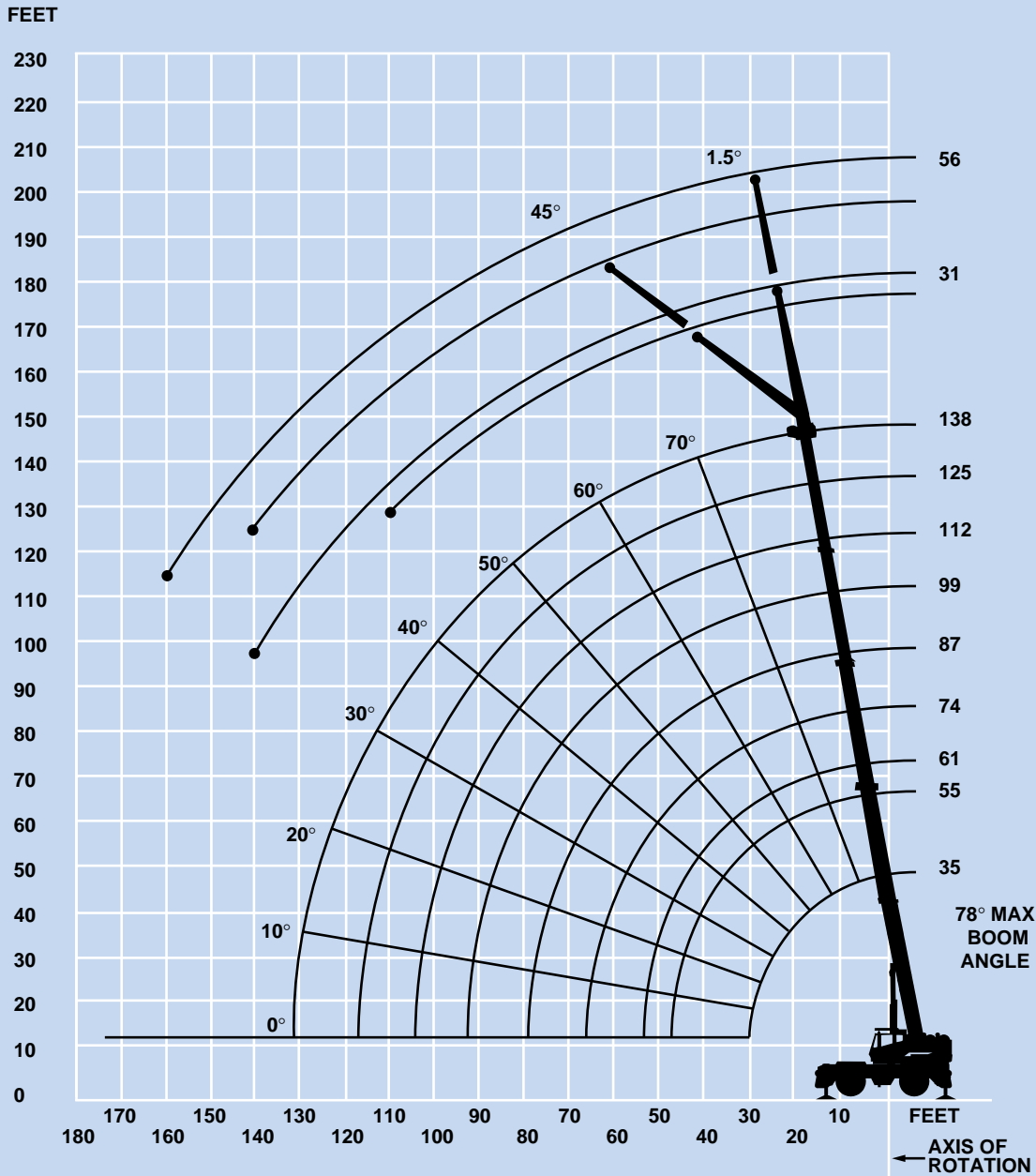

DIMENSIONS ARE FOR LARGEST GROVE FURNISHED HOOK BLOCK AND HEADACHEBALL, WITH ANTI-TWO BLOCK ACTIVATED.



Superstructure specifications

Boom

35 ft. - 138 ft. (10.6 m - 42 m) five-section full power boom.

Maximum Tip Height: 148 ft. (45.1 m).

Folding Lattice Extension

31 ft. - 56 ft. (9.4 m - 17 m) bi-fold lattice swingaway extension offsettable at 1.5° or 45° Stows alongside base section.

Maximum Tip Height: 204 ft. (62.1 m).

*Optional Lattice Extension

31 ft. (9.4 m) lattice swingaway extension. Offsettable at 1.5° or 45°. Stows alongside base boom section.

Maximum Tip Height: 179 ft. (54.5 m).

Boom Nose

Five Nylatron sheaves mounted on heavy duty tapered roller bearings with removable pin-type rope guards.

Quick reeving type boom nose. A removable auxiliary boom nose with removable pin type rope guard.

Boom Elevation

One double acting hydraulic cylinder with integral holding valve provides elevation from -3° to 78°.

Load Moment & Anti-Two Block System

Standard load moment and anti-two block system with audio-visual warning and control lever lockout. These systems provide electronic display of boom angle, length, radius, tip height, relative load moment, maximum permissible load and load indication and warning of impending two-block condition.

Cab

Full vision, all galvanealed steel fabricated with acoustical lining and tinted safety glass throughout. Deluxe seat with armrest mounted hydraulic single axis controllers. Dash panel incorporates gauges for engine functions. Other standard features include: skylight screen, hydraulic oil cab heater/defroster, telescoping tilt wheel, sliding side and rear windows, opening skylight, electric windshield wash-wipe, electric skylight wipers, fire extinguisher, seat belt, ashtray and level indicator.

Swing

Planetary swing with foot applied multi-disc wet brake. Spring applied, hydraulically released swing brake, 360° positive swing lock (N.Y.C. style) and 1 position, mechanical house lock, operated from cab.

Maximum speed: 2.0 RPM.

Counterweight

Removable: 8,500 lbs. (3855 kg).

2,155 lbs. (977 kg) slab I.P.O. auxiliary hoist.

Hydraulic System

Seven main pumps with a combined capacity 199.2 GPM (754 LPM). Maximum operating pressure 3500 psi (241 bar). Three individual valve banks. Return line type filter with full flow by-pass protection and service indicator. Replaceable cartridge with micron filtration rating of 5/12/16. 200 gallons (757 L) reservoir. Remote mounted oil cooler with thermostatically controlled hydraulic motor driven fan/air to oil. System pressure test panel with quick release type fittings for each circuit.

Hoist Specifications Main and Auxiliary Hoist

Planetary reduction with automatic spring applied multi-disc brake. Electronic hoist drum rotation indicator, hoist drum cable followers and wire rope.

Maximum Single Line Pull:	16,969 lbs. (7697 kg)
Maximum Single Line Speed:	385 FPM (117 m/min)
Maximum Permissible Line Pull:	12,920 lbs. (5860 kg)
Rope Diameter:	3/4 in. (19 mm)
Rope Length:	620 ft. (190 m)
Maximum Rope Stowage:	1,163 ft. (354.5 m)



Carrier specifications

Chassis

Box section frame fabricated from high-strength, low alloy steel. Integral outrigger housings and front/rear towing and tie down lugs.

Outrigger System

Four hydraulic telescoping single-stage double box beam outriggers with inverted jacks and integral holding valves. Three position setting. All steel fabricated quick release type outrigger floats, 30.5" (77.5 mm) diameter.
Maximum outrigger pad load: 94,000 lbs. (42 638 kg).

Outrigger Controls

Controls and crane level indicator located in cab.

Engine

Cummins 6CTA 8.3 diesel, six cylinders, turbocharged, 250 bhp (186 kW) (Gross) @ 2,200 RPM.
Maximum torque: 794 ft. lbs. (1077 Nm) @ 1,500 RPM.

*Optional Engine

Caterpillar 3126TA diesel, six cylinders, turbocharged, 250 bhp (186 kW) (Gross) @ 2,500 RPM.
Maximum torque: 686 ft. lbs. (930 Nm) @ 1,650 RPM.

Fuel Tank Capacity

80 gallons (303 L)

Transmission

Full powershift with 6 forward and 6 reverse speeds.
Rear axle disconnect for 4 x 2 travel.

Electrical System

Two 12 V - maintenance free batteries. 24 V starting and lighting.

Drive

4 x 4.

Steering

Fully independent power steering:
Front: Full hydraulic steering wheel controlled.
Rear: Full hydraulic hand lever controlled.
Provides infinite variations of 4 main steering modes: front only, rear only, crab and coordinated.
Rear steer indicating gauge.

Axles

Front: Drive steer with differential and planetary reduction hubs rigid mounted to frame.
Rear: Drive/steer with differential and planetary reduction hubs pivot mounted to frame.
Automatic full hydraulic lockouts on rear axle.

Oscillation Lockouts

Automatic full hydraulic lockouts on rear axle permits oscillation only with boom centered over the front.

Brakes

Full air split circuit operating on all wheels.
Spring-applied, air released front and rear axles.

Tires

Std. 33.25 x 29 - 32PR earthmover type.
*Optional: 33.25R29 radial.

Lights

Full lighting including turn indicators, head, tail, brake, and hazard warning lights.

Maximum Speed

25 MPH (40 kph).

Gradeability (Theoretical)

87% based on 102,840 lbs. (46 648 kg) GVW.
33.25 x 29 tires, pumps disengaged, 138 ft. (42 m) boom, plus 31 ft. (9.4 m) swingaway.

Miscellaneous Standard Equipment

Full width steel fenders, dual rear view mirrors, hookblock tiedown, electronic back-up alarm, light package, front stowage well, tachometer/hourmeter, cold start aid (less canister), rear wheel position indicator, hydraulic cab heater, hoist mirrors, engine distress A/V warning system, tire inflation kit.

*Optional Equipment

- * Boom mounted worklights
- * 360° flashing light
- * Cab spotlight remote mounted
- * Engine block heater
- * Hookblocks (quick reeving type)
- * Tow winch - front mounted -- maximum pull 15,000 lbs. (6804 kg); maximum speed 92 ft./min. (28 m/min)
- * Spare tire & wheel assembly
- * Tool kit
- * Pintle hook front/rear
- * High Speed Glide system
- * Air conditioning
- * Dual axis joystick controllers
- * Auxiliary oil cooler
- * Emergency steer pump
- * Propane heater
- * T/T lube system
- * Hoist mounted work light
- * Counterweight removal system
- * 3rd wrap indicators (main or auxiliary)
- * LMI light bar
- * Cross axle differential locks
- * Oscillation lockout override control

**Denotes optional equipment*



35 - 138 ft.
(10.6 - 42.0 m)



8,500 lbs.
(3855 kg)



100%



360°



(Pounds)

(Feet)	35	55	61	74	87	99	112	125	138
10	130,000 (65.5)	79,100 (76)	78,450 (77.5)	*57,050 (80)					
12	106,500 (62)	79,100 (73.5)	77,500 (75.5)	57,050 (78.5)	*43,300 (80)				
15	90,050 (56)	79,100 (70)	69,850 (72.5)	51,650 (76)	43,300 (78.5)	*32,100 (80)			
20	68,300 (44.5)	67,350 (64.5)	59,850 (67.5)	44,350 (71.5)	39,550 (75)	32,100 (77.5)	*30,050 (80)	*20,150 (80)	
25	52,250 (29.5)	51,150 (58)	51,450 (62)	38,750 (67.5)	33,800 (71.5)	32,100 (74.5)	30,050 (77)	20,150 (79)	*19,000 (80)
30		39,200 (51)	39,450 (56.5)	34,200 (63)	29,200 (68)	30,200 (71.5)	27,350 (74.5)	19,100 (76.5)	18,300 (78.5)
35		31,000 (43.5)	31,300 (50)	29,050 (58.5)	25,800 (64)	26,600 (68.5)	24,300 (71.5)	18,100 (74)	17,650 (76.5)
40		25,050 (34.5)	25,350 (43)	25,150 (53.5)	22,900 (60)	23,450 (65)	21,600 (69)	17,250 (72)	17,000 (74)
45		20,500 (21.5)	20,800 (35)	20,600 (48.5)	20,000 (56)	20,450 (61.5)	19,250 (66)	16,450 (69)	16,350 (72)
50			17,250 (24.5)	16,850 (42.5)	16,900 (52)	17,900 (58.5)	16,900 (63)	15,750 (66.5)	15,700 (69.5)
60				10,500 (28)	10,600 (42.5)	11,800 (51)	13,000 (57)	13,100 (61.5)	13,300 (65)
70					6,500 (30)	7,670 (42.5)	8,860 (50)	10,050 (56)	11,050 (60)
80						4,710 (32)	5,910 (42.5)	7,090 (49.5)	8,290 (55)
90						2,390 (15.5)	3,690 (33.5)	4,880 (43)	6,060 (49.5)
100							1,910 (21)	3,170 (35)	4,340 (43)
110								1,810 (24.5)	2,970 (36)
120									1,860 (27)
Min. boom angle (deg.) for indicated length (no load)								16	18
Max. boom length (ft.) at 0 degree boom angle (no load)									112

NOTE: () Boom angles are in degrees.

*This capacity is based upon maximum boom angle.

Boom Angle	35	55	61	74	87	99	112
0°	27,400 (28.2)	12,850 (47.4)	10,400 (53.8)	6,290 (66.6)	3,380 (79.4)	1,970 (92.2)	1,170 (105)

NOTE: () Reference radii in feet.

A6-829-014847A

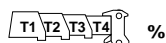

	T1	T2	T3	T4	T1	T2	T3	T4
T1	0	50	50	75	100	100	100	100
T2	0	25	50	75	100	100	100	100
T3	0	0	0	0	0	25	50	75
T4	0	0	0	0	0	25	50	75

THIS CHART IS ONLY A GUIDE AND SHOULD NOT BE USED TO OPERATE THE CRANE. The individual crane's load chart, operating instructions and other instructional plates must be read and understood prior to operating the crane.





35 - 138 ft.
(10.6 - 42.0 m)



8,500 lbs.
(3855 kg)



50%



360°



(Pounds)

(Feet)	35	55	61	74	87	99	112	125	138
10	115,000 (65.5)	79,100 (76)	78,450 (77.5)	*57,050 (80)					
12	101,500 (62)	79,100 (73.5)	77,500 (75.5)	57,050 (78.5)	*43,300 (80)				
15	86,150 (56)	79,100 (70)	69,850 (72.5)	51,650 (76)	43,300 (78.5)	*32,100 (80)			
20	62,850 (44.5)	56,100 (64.5)	55,000 (67.5)	44,350 (71.5)	39,550 (75)	32,100 (77.5)	*30,050 (80)	*20,150 (80)	
25	39,750 (29.5)	37,950 (58)	38,300 (62)	35,950 (67.5)	33,800 (71.5)	32,100 (74.5)	30,050 (77)	20,150 (79)	*19,000 (80)
30		26,000 (51)	26,800 (56.5)	26,450 (63)	25,150 (68)	25,800 (71.5)	26,150 (74.5)	19,100 (76.5)	18,300 (78.5)
35		18,550 (43.5)	19,250 (50)	18,800 (58.5)	18,700 (64)	19,900 (68.5)	20,500 (71.5)	18,100 (74)	17,650 (76.5)
40		13,550 (34.5)	14,100 (43)	13,550 (53.5)	13,550 (60)	14,750 (65)	15,900 (69)	16,750 (72)	17,000 (74)
45		9,890 (21.5)	10,350 (35)	9,800 (48.5)	9,810 (56)	10,950 (61.5)	12,150 (66)	13,300 (69)	14,000 (72)
50			7,560 (24.5)	6,930 (42.5)	6,980 (52)	8,140 (58.5)	9,310 (63)	10,450 (66.5)	11,600 (69.5)
60				2,870 (28)	2,970 (42.5)	4,110 (51)	5,260 (57)	6,400 (61.5)	7,540 (65)
70						1,400 (42.5)	2,530 (50)	3,660 (56)	4,790 (60)
80								1,690 (49.5)	2,810 (55)
90									1,310 (49.5)
0.1A (lbs.)	1,270	1,340	1,310	1,330	1,350	1,230	1,140	1,070	1,010
Min. boom angle (deg.) for indicated length (no load)				24	35	40	43	45	47
Max. boom length (ft.) at 0 degree boom angle (no load)									61

NOTE: () Boom angles are in degrees.
*This capacity is based upon maximum boom angle.

Boom Angle	35	55	61
0°	27,400 (28.2)	8,500 (47.4)	5,850 (53.8)

NOTE: () Reference radii in feet.

A6-829-014849A

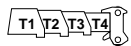

%

T1	0	50	50	75	100	100	100	100	100
T2	0	25	50	75	100	100	100	100	100
T3	0	0	0	0	0	25	50	75	100
T4	0	0	0	0	0	25	50	75	100

THIS CHART IS ONLY A GUIDE AND SHOULD NOT BE USED TO OPERATE THE CRANE. The individual crane's load chart, operating instructions and other instructional plates must be read and understood prior to operating the crane.

RT865BXL

7



35 - 138 ft.
(10.6 - 42.0 m)



8,500 lbs.
(3855 kg)



0%



360°



(Pounds)

(Feet)	35	55	61	74	87	99	112	125	138
10	86,700 (65.5)	71,750 (76)	69,000 (77.5)	*57,050 (80)					
12	65,550 (62)	55,400 (73.5)	53,700 (75.5)	49,100 (78.5)	*43,300 (80)				
15	46,750 (56)	40,050 (70)	39,200 (72.5)	36,150 (76)	33,550 (78.5)	*32,100 (80)			
20	29,400 (44.5)	25,650 (64.5)	25,350 (67.5)	23,500 (71.5)	21,950 (75)	22,400 (77.5)	*22,550 (80)	*20,150 (80)	
25	19,100 (29.5)	17,450 (58)	17,400 (62)	16,050 (67.5)	14,950 (71.5)	15,750 (74.5)	16,200 (77)	16,450 (79)	*16,550 (80)
30		11,450 (51)	12,150 (56.5)	11,150 (63)	10,300 (68)	11,250 (71.5)	11,850 (74.5)	12,250 (76.5)	12,500 (78.5)
35		7,350 (43.5)	7,950 (50)	7,540 (58.5)	6,980 (64)	8,020 (68.5)	8,730 (71.5)	9,230 (74)	9,580 (76.5)
40		4,420 (34.5)	4,940 (43)	4,460 (53.5)	4,430 (60)	5,570 (65)	6,350 (69)	6,910 (72)	7,320 (74)
45		2,240 (21.5)	2,690 (35)	2,150 (48.5)	2,160 (56)	3,290 (61.5)	4,410 (66)	5,080 (69)	5,530 (72)
50						1,500 (58.5)	2,590 (63)	3,600 (66.5)	4,080 (69.5)
60									1,880 (65)
0.1A (lbs.)	1,270	1,340	1,310	1,330	1,350	1,230	1,140	1,070	1,010
Min. boom angle (deg.) for indicated length (no load)			25	44	53	56	59	62	62
Max. boom length (ft.) at 0 degree boom angle (no load)									55

NOTE: () Boom angles are in degrees.
*This capacity is based upon maximum boom angle.

Boom Angle	35	55
0°	14,950 (28.2)	1,390 (47.4)

NOTE: () Reference radii in feet.

A6-829-014851A



	T1	T2	T3	T4
T1	0	50	50	75
T2	0	25	50	75
T3	0	0	0	0
T4	0	0	0	0

THIS CHART IS ONLY A GUIDE AND SHOULD NOT BE USED TO OPERATE THE CRANE. The individual crane's load chart, operating instructions and other instructional plates must be read and understood prior to operating the crane.





35 - 138 ft.
(10.6 - 42.0 m)



0 lbs.
(0 kg)



100%



360°



(Pounds)

(Feet)	35	55	61	74	87	99	112	125	138
10	122,000 (65.5)	79,100 (76)	78,450 (77.5)	*57,050 (80)					
12	104,500 (62)	79,100 (73.5)	77,500 (75.5)	57,050 (78.5)	*43,300 (80)				
15	85,800 (56)	79,100 (70)	69,850 (72.5)	51,650 (76)	43,300 (78.5)	*32,100 (80)			
20	63,400 (44.5)	62,150 (64.5)	59,850 (67.5)	44,350 (71.5)	39,550 (75)	32,100 (77.5)	*30,050 (80)	*20,150 (80)	
25	46,000 (29.5)	44,900 (58)	45,200 (62)	38,750 (67.5)	33,800 (71.5)	32,100 (74.5)	30,050 (77)	20,150 (79)	*19,000 (80)
30		34,100 (51)	34,400 (56.5)	34,150 (63)	29,200 (68)	30,200 (71.5)	27,350 (74.5)	19,100 (76.5)	18,300 (78.5)
35		26,750 (43.5)	27,000 (50)	26,800 (58.5)	25,800 (64)	26,600 (68.5)	24,300 (71.5)	18,100 (74)	17,650 (76.5)
40		21,350 (34.5)	21,650 (43)	21,450 (53.5)	21,300 (60)	22,600 (65)	21,600 (69)	17,250 (72)	17,000 (74)
45		16,200 (21.5)	16,750 (35)	16,100 (48.5)	16,150 (56)	17,400 (61.5)	18,700 (66)	16,450 (69)	16,350 (72)
50			12,900 (24.5)	12,200 (42.5)	12,250 (52)	13,500 (58.5)	14,750 (63)	15,750 (66.5)	15,700 (69.5)
60				6,830 (28)	6,950 (42.5)	8,140 (51)	9,360 (57)	10,550 (61.5)	11,800 (65)
70					3,450 (30)	4,620 (42.5)	5,810 (50)	7,020 (56)	8,230 (60)
80						2,080 (32)	3,310 (42.5)	4,490 (49.5)	5,690 (55)
90							1,400 (33.5)	2,610 (43)	3,790 (49.5)
100								1,160 (35)	2,330 (43)
110									1,170 (36)
Min. boom angle (deg.) for indicated length (no load)					22	27	31	33	34
Max. boom length (ft.) at 0 degree boom angle (no load)					74				

NOTE: () Boom angles are in degrees.
*This capacity is based upon maximum boom angle.

Boom Angle	35	55	61	74
0°	27,400 (28.2)	12,850 (47.4)	10,400 (53.8)	4,370 (66.6)

NOTE: () Reference radii in feet.

A6-829-014848A



	T1	T2	T3	T4	%
T1	0	50	50	75	100
T2	0	25	50	75	100
T3	0	0	0	0	25
T4	0	0	0	0	25

THIS CHART IS ONLY A GUIDE AND SHOULD NOT BE USED TO OPERATE THE CRANE. The individual crane's load chart, operating instructions and other instructional plates must be read and understood prior to operating the crane.

RT865BXL

9



35 - 138 ft.
(10.6 - 42.0 m)



0 lbs.
(0 kg)



50%



360°



(Pounds)

(Feet)	35	55	61	74	87	99	112	125	138
10	112,500 (65.5)	79,100 (76)	78,450 (77.5)	*57,050 (80)					
12	99,350 (62)	79,100 (73.5)	77,500 (75.5)	57,050 (78.5)	*43,300 (80)				
15	84,050 (56)	73,500 (70)	69,850 (72.5)	51,650 (76)	43,300 (78.5)	*32,100 (80)			
20	50,150 (44.5)	44,350 (64.5)	43,550 (67.5)	40,400 (71.5)	37,800 (75)	32,100 (77.5)	*30,050 (80)	*20,150 (80)	
25	30,950 (29.5)	29,150 (58)	29,650 (62)	27,650 (67.5)	26,000 (71.5)	26,550 (74.5)	26,750 (77)	20,150 (79)	*19,000 (80)
30		19,250 (51)	20,050 (56.5)	19,700 (63)	18,650 (68)	19,500 (71.5)	19,950 (74.5)	19,100 (76.5)	18,300 (78.5)
35		13,100 (43.5)	13,800 (50)	13,300 (58.5)	13,200 (64)	14,450 (68.5)	15,250 (71.5)	15,700 (74)	15,950 (76.5)
40		8,950 (34.5)	9,520 (43)	8,990 (53.5)	8,960 (60)	10,150 (65)	11,300 (69)	12,300 (72)	12,650 (74)
45		5,930 (21.5)	6,420 (35)	5,840 (48.5)	5,850 (56)	7,030 (61.5)	8,200 (66)	9,380 (69)	10,100 (72)
50			4,070 (24.5)	3,450 (42.5)	3,490 (52)	4,660 (58.5)	5,820 (63)	6,980 (66.5)	8,130 (69.5)
60						1,310 (51)	2,450 (57)	3,590 (61.5)	4,730 (65)
70								1,310 (56)	2,440 (60)
0.1A (lbs.)	1,270	1,340	1,310	1,330	1,350	1,230	1,140	1,070	1,010
Min. boom angle (deg.) for indicated length (no load)				30	43	48	51	54	56
Max. boom length (ft.) at 0 degree boom angle									61

NOTE: () Boom angles are in degrees.

*This capacity is based upon maximum boom angle.

Boom Angle	35	55	61
0°	23,900 (28.2)	4,780 (47.4)	2,660 (53.8)

NOTE: () Reference radii in feet.

A6-829-014850A



	T1	T2	T3	T4	%
T1	0	50	50	75	100
T2	0	25	50	75	100
T3	0	0	0	0	25
T4	0	0	0	0	25

THIS CHART IS ONLY A GUIDE AND SHOULD NOT BE USED TO OPERATE THE CRANE. The individual crane's load chart, operating instructions and other instructional plates must be read and understood prior to operating the crane.



35 - 138 ft.
(10.6 - 42.0 m)



0 lbs.
(0 kg)



0%



360°



(Pounds)

(Feet)	35	55	61	74	87	99	112	125	138
10	66,900 (65.5)	54,600 (76)	52,500 (77.5)	*47,100 (80)					
12	49,950 (62)	41,500 (73.5)	40,300 (75.5)	36,500 (78.5)	*33,350 (80)				
15	34,950 (56)	29,300 (70)	28,700 (72.5)	26,200 (76)	24,100 (78.5)	*24,300 (80)			
20	21,300 (44.5)	17,800 (64.5)	17,700 (67.5)	16,100 (71.5)	14,800 (75)	15,550 (77.5)	*15,900 (80)	*16,050 (80)	
25	13,050 (29.5)	11,250 (58)	11,300 (62)	10,150 (67.5)	9,250 (71.5)	10,200 (74.5)	10,800 (77)	11,200 (79)	*11,400 (80)
30		6,630 (51)	7,190 (56.5)	6,260 (63)	5,540 (68)	6,600 (71.5)	7,330 (74.5)	7,840 (76.5)	8,190 (78.5)
35		3,330 (43.5)	3,930 (50)	3,480 (58.5)	2,880 (64)	4,010 (68.5)	4,810 (71.5)	5,390 (74)	5,810 (76.5)
40			1,500 (43)	1,020 (53.5)		2,060 (65)	2,890 (69)	3,520 (72)	3,980 (74)
45							1,390 (66)	2,040 (69)	2,540 (72)
50									1,380 (69.5)
0.1A (lbs.)	1,270	1,340	1,310	1,330	1,350	1,230	1,140	1,070	1,010
Min. boom angle (deg.) for indicated length (no load)		36	41	52	61	62	64	67	67
Max. boom length (ft.) at 0 degree boom angle (no load)									35

NOTE: () Boom angles are in degrees.

*This capacity is based upon maximum boom angle.

Boom
Angle

35

0°

9,750
(28.2)

NOTE: () Reference radii in feet.

A6-829-014896A

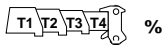

	T1	T2	T3	T4					
T1	0	50	50	75	100	100	100	100	100
T2	0	25	50	75	100	100	100	100	100
T3	0	0	0	0	0	25	50	75	100
T4	0	0	0	0	0	25	50	75	100

THIS CHART IS ONLY A GUIDE AND SHOULD NOT BE USED TO OPERATE THE CRANE. The individual crane's load chart, operating instructions and other instructional plates must be read and understood prior to operating the crane.

RT865BXL

11





138 ft.
(42.0 m)



31 - 56 ft.
(9.4 - 17 m)



8,500 lbs.
(3855 kg)



100%



360°



(Pounds)

(Feet)	31 FT. LENGTH		56 FT. LENGTH	
	1.5° OFFSET	45° OFFSET	1.5° OFFSET	45° OFFSET
35	9,500 (79.5)			
40	9,500 (78)		*5,500 (80)	
45	9,500 (76.5)		5,400 (79.5)	
50	9,500 (75)	*7,800 (80)	5,300 (78)	
60	9,110 (71.5)	6,740 (77)	5,100 (75.5)	
70	8,450 (68.5)	6,460 (73.5)	4,900 (72.5)	*3,600 (80)
80	7,550 (64.5)	6,350 (69.5)	4,700 (69.5)	3,500 (77.5)
90	6,990 (60.5)	6,280 (65.5)	4,500 (66.5)	3,400 (74)
100	5,480 (56.5)	6,220 (61)	4,300 (63.5)	3,300 (70.5)
110	3,980 (52)	4,710 (56.5)	4,100 (59.5)	3,200 (67)
120	2,750 (47)	3,320 (51)	3,650 (56)	3,100 (63)
130	1,740 (41.5)		2,690 (52)	3,000 (58.5)
140			1,870 (47.5)	2,540 (53.5)
150			1,130 (42.5)	
Minimum boom angle (deg.) for indicated length (no load)	37	45	42	47
Maximum boom length (ft.) at 0 degree boom angle (no load)		87		74

NOTE: () Boom angles are in degrees.

*This capacity is based upon maximum boom angle.

A6-829-014897

THIS CHART IS ONLY A GUIDE AND SHOULD NOT BE USED TO OPERATE THE CRANE. The individual crane's load chart, operating instructions and other instructional plates must be read and understood prior to operating the crane.





35 - 138 ft.
(10.6 - 42.0 m)



31 - 56 ft.
(9.4 - 17 m)



8,500 lbs.
(3855 kg)



50%



360°



(Pounds)

(Feet)	31 FT. LENGTH		56 FT. LENGTH	
	1.5° OFFSET	45° OFFSET	1.5° OFFSET	45° OFFSET
35	9,500 (79.5)			
40	9,500 (78)		*5,500 (80)	
45	9,500 (76.5)		5,400 (79.5)	
50	9,500 (75)	*7,800 (80)	5,300 (78)	
60	8,220 (71.5)	6,740 (77)	5,100 (75.5)	
70	5,760 (68.5)	6,460 (73.5)	4,900 (72.5)	*3,600 (80)
80	3,920 (64.5)	5,450 (69.5)	4,460 (69.5)	3,500 (77.5)
90	2,480 (60.5)	3,690 (65.5)	3,030 (66.5)	3,400 (74)
100	1,220 (56.5)	2,140 (61)	1,890 (63.5)	3,300 (70.5)
110				2,280 (67)
120				1,230 (63)
0.1A (lbs.)	960	880	900	810
Minimum boom angle (deg.) for indicated length (no load)	53	57	59	61
Maximum boom length (ft.) at 0 degree boom angle (no load)		61		35

NOTE: () Boom angles are in degrees.

*This capacity is based upon maximum boom angle.

A6-829-014901B

THIS CHART IS ONLY A GUIDE AND SHOULD NOT BE USED TO OPERATE THE CRANE. The individual crane's load chart, operating instructions and other instructional plates must be read and understood prior to operating the crane.

RT865BXL

13





35 - 138 ft.
(10.6 - 42.0 m)



31 - 56 ft.
(9.4 - 17 m)



0 lbs.
(0 kg)



100%



360°



(Pounds)

(Feet)	31 FT. LENGTH		56 FT. LENGTH	
	1.5° OFFSET	45° OFFSET	1.5° OFFSET	45° OFFSET
35	9,500 (79.5)			
40	9,500 (78)		*5,500 (80)	
45	9,500 (76.5)		5,400 (79.5)	
50	9,500 (75)	*7,800 (80)	5,300 (78)	
60	9,110 (71.5)	6,740 (77)	5,100 (75.5)	
70	8,450 (68.5)	6,460 (73.5)	4,900 (72.5)	*3,600 (80)
80	7,210 (64.5)	6,350 (69.5)	4,700 (69.5)	3,500 (77.5)
90	5,100 (60.5)	6,280 (65.5)	4,500 (66.5)	3,400 (74)
100	3,470 (56.5)	4,420 (61)	4,300 (63.5)	3,300 (70.5)
110	2,170 (52)	2,910 (56.5)	3,210 (59.5)	3,200 (67)
120	1,120 (47)	1,680 (51)	2,170 (56)	3,090 (63)
130			1,260 (52)	2,040 (58.5)
140				1,160 (53.5)
Minimum boom angle (deg.) for indicated length (no load)	46	49	50	52
Maximum boom length (ft.) at 0 degree boom angle (no load)		74		61

NOTE: () Boom angles are in degrees.
*This capacity is based upon maximum boom angle.

A6-829-014899A

THIS CHART IS ONLY A GUIDE AND SHOULD NOT BE USED TO OPERATE THE CRANE. The individual crane's load chart, operating instructions and other instructional plates must be read and understood prior to operating the crane.





125 ft.
(38.1 m)



31 - 56 ft.
(9.4 - 17 m)



8,500 lbs.
(3855 kg)



100%



360°



(Pounds)

(Feet)	31 FT. LENGTH		56 FT. LENGTH	
	1.5° OFFSET	45° OFFSET	1.5° OFFSET	45° OFFSET
30	*11,500 (80)			
35	11,500 (78.5)			
40	11,500 (77)		6,950 (79.5)	
45	11,500 (75)	*8,000 (80)	6,780 (78.5)	
50	11,000 (73.5)	6,810 (78.5)	6,620 (77)	
60	10,050 (70)	6,490 (74.5)	6,290 (74)	
70	9,220 (66)	6,400 (70.5)	5,960 (71)	*3,700 (80)
80	8,440 (62)	6,350 (66)	5,640 (67.5)	3,520 (76.5)
90	6,900 (57.5)	6,340 (61.5)	5,260 (64.5)	3,400 (72.5)
100	5,090 (53)	5,860 (56.5)	4,980 (60.5)	3,290 (68.5)
110	3,640 (47.5)	4,180 (51)	4,630 (56.5)	3,190 (64)
120	2,450 (41.5)		3,420 (52)	3,110 (59.5)
130	1,450 (34.5)		2,360 (47.5)	3,040 (54)
140			1,460 (42.5)	
Minimum boom angle (deg.) for indicated length (no load)	33	45	39	49
Maximum boom length (ft.) at 0 degree boom angle (no load)		87		74

NOTE: () Boom angles are in degrees.

*This capacity is based upon maximum boom angle.

A6-829-014898A

THIS CHART IS ONLY A GUIDE AND SHOULD NOT BE USED TO OPERATE THE CRANE. The individual crane's load chart, operating instructions and other instructional plates must be read and understood prior to operating the crane.

RT865BXL

15



35 - 125 ft.
(10.6 - 38.1 m)



31 - 56 ft.
(9.4 - 17 m)



8,500 lbs.
(3855 kg)



50%



360°



(Pounds)

(Feet)	31 FT. LENGTH		56 FT. LENGTH	
	1.5° OFFSET	45° OFFSET	1.5° OFFSET	45° OFFSET
30	*11,500 (80)			
35	11,500 (78.5)			
40	11,500 (77)		6,950 (79.5)	
45	11,500 (75)	*8,000 (80)	6,780 (78.5)	
50	11,000 (73.5)	6,810 (78.5)	6,620 (77)	
60	8,070 (70)	6,490 (74.5)	6,290 (74)	
70	5,580 (66)	6,400 (70.5)	5,960 (71)	*3,700 (80)
80	3,710 (62)	5,080 (66)	4,390 (67.5)	3,520 (76.5)
90	2,100 (57.5)	3,130 (61.5)	2,940 (64.5)	3,400 (72.5)
100		1,610 (56.5)	1,790 (60.5)	3,290 (68.5)
110				2,430 (64)
120				1,230 (59.5)
0.1A (lbs.)	990	900	910	810
Minimum boom angle (deg.) for indicated length (no load)	53	55	57	58
Maximum boom length (ft.) at 0 degree boom angle (no load)		61		35

NOTE: () Boom angles are in degrees.
*This capacity is based upon maximum boom angle.

A6-829-014902A

THIS CHART IS ONLY A GUIDE AND SHOULD NOT BE USED TO OPERATE THE CRANE. The individual crane's load chart, operating instructions and other instructional plates must be read and understood prior to operating the crane.





35 - 125 ft.
(10.6 - 38.1 m)



31 - 56 ft.
(9.4 - 17 m)



0 lbs.
(0 kg)



100%



360°



(Pounds)

(Feet)	31 FT. LENGTH		56 FT. LENGTH	
	1.5° OFFSET	45° OFFSET	1.5° OFFSET	45° OFFSET
30	*11,500 (80)			
35	11,500 (78.5)			
40	11,500 (77)		6,950 (79.5)	
45	11,500 (75)	*8,000 (80)	6,780 (78.5)	
50	11,000 (73.5)	6,810 (78.5)	6,620 (77)	
60	10,050 (70)	6,490 (74.5)	6,290 (74)	
70	9,220 (66)	6,400 (70.5)	5,960 (71)	*3,700 (80)
80	6,670 (62)	6,350 (66)	5,640 (67.5)	3,520 (76.5)
90	4,650 (57.5)	5,710 (61.5)	5,260 (64.5)	3,400 (72.5)
100	3,080 (53)	3,860 (56.5)	4,270 (60.5)	3,290 (68.5)
110	1,830 (47.5)	2,380 (51)	2,900 (56.5)	3,190 (64)
120			1,790 (52)	3,110 (59.5)
130				1,920 (54)
Minimum boom angle (deg.) for indicated length (no load)	42	46	48	51
Maximum boom length (ft.) at 0 degree boom angle (no load)		74		61

NOTE: () Boom angles are in degrees.

*This capacity is based upon maximum boom angle.

A6-829-014900

THIS CHART IS ONLY A GUIDE AND SHOULD NOT BE USED TO OPERATE THE CRANE. The individual crane's load chart, operating instructions and other instructional plates must be read and understood prior to operating the crane.

RT865BXL

17



35 - 138 ft.
(10.6 - 42.0 m)



8,500 lbs.
(3855 kg)



Stationary
33.25 x 29
(32 ply)



360°



(Pounds)

(Feet)	35	55	61	74	87
10	45,200 (65.5)	40,850 (76)			
12	43,100 (62)	40,850 (73.5)			
15	29,400 (56)	29,400 (70)	29,400 (72.5)	29,400 (76)	
20	17,750 (44.5)	17,750 (64.5)	17,750 (67.5)	17,750 (71.5)	17,750 (75)
25	11,300 (29.5)	11,300 (58)	11,300 (62)	11,300 (67.5)	11,300 (71.5)
30		7,300 (51)	7,300 (56.5)	7,300 (63)	7,300 (68)
35		4,520 (43.5)	4,520 (50)	4,520 (58.5)	4,520 (64)
40		2,290 (34.5)	2,290 (43)	2,290 (53.5)	2,290 (60)
Minimum boom angle (deg.) for indicated length (no load)		31	40	50	58
Maximum boom length (ft.) at 0 degree boom angle (no load)					35

NOTE: () Boom angles are in degrees.

Boom
Angle

	35
0°	9,350 (28.2)

NOTE: () Reference radii in feet.

A6-829-015116

THIS CHART IS ONLY A GUIDE AND SHOULD NOT BE USED TO OPERATE THE CRANE. The individual crane's load chart, operating instructions and other instructional plates must be read and understood prior to operating the crane.





35 - 138 ft.
(10.6 - 42.0 m)



8,500 lbs.
(3855 kg)



Stationary
33.25 x 29
(32 ply)



Defined Arc
Over Front



(Pounds)

(Feet)	35	55	61	74	87
10	45,200 (65.5)	40,850 (76)			
12	45,200 (62)	40,850 (73.5)	40,850 (75.5)		
15	45,200 (56)	40,850 (70)	40,850 (72.5)	34,400 (76)	
20	40,850 (44.5)	40,850 (64.5)	40,850 (67.5)	34,400 (71.5)	24,050 (75)
25	27,000 (29.5)	27,100 (58)	27,100 (62)	27,100 (67.5)	24,050 (71.5)
30		19,200 (51)	19,200 (56.5)	19,200 (63)	19,200 (68)
35		14,200 (43.5)	14,200 (50)	14,200 (58.5)	14,200 (64)
40		10,550 (34.5)	10,550 (43)	10,550 (53.5)	10,550 (60)
45		7,905 (21.5)	7,905 (35)	7,905 (48.5)	7,905 (56)
50			5,840 (24.5)	5,840 (42.5)	5,840 (52)
60				2,880 (28)	2,880 (42.5)

Minimum boom angle (deg.) for indicated length (no load) 40

Maximum boom length (ft.) at 0 degree boom angle (no load) 74

NOTE: () Boom angles are in degrees.

Boom Angle	35	55	61	74
0°	22,000 (28.2)	6,860 (47.4)	4,570 (53.8)	1,480 (66.6)

NOTE: () Reference radii in feet.

A6-829-015117

THIS CHART IS ONLY A GUIDE AND SHOULD NOT BE USED TO OPERATE THE CRANE. The individual crane's load chart, operating instructions and other instructional plates must be read and understood prior to operating the crane.

RT865BXL

19



35 - 138 ft.
(10.6 - 42.0 m)



8,500 lbs.
(3855 kg)



Pick & Carry
Up to 2.5 MPH
33.25 x 29 (32 ply)



Boom Centered
Over Front



(Pounds)

(Feet)	35	55	61	74	87
10	45,200 (65.5)	29,150 (76)			
12	45,200 (62)	29,150 (73.5)			
15	37,250 (56)	29,150 (70)	26,900 (72.5)	18,150 (76)	
20	30,600 (44.5)	29,150 (64.5)	26,900 (67.5)	18,150 (71.5)	12,400 (75)
25	20,250 (29.5)	20,250 (58)	20,250 (62)	18,150 (67.5)	12,400 (71.5)
30		14,400 (51)	14,400 (56.5)	14,440 (63)	12,400 (68)
35		10,650 (43.5)	10,650 (50)	10,650 (58.5)	10,650 (64)
40		7,940 (34.5)	7,940 (43)	7,940 (53.5)	7,940 (60)
45		5,920 (21.5)	5,920 (35)	5,920 (48.5)	5,920 (56)
50			4,380 (24.5)	4,380 (42.5)	4,380 (52)
60				2,160 (28)	2,160 (42.5)
Minimum boom angle (deg.) for indicated length (no load)					40
Maximum boom length (ft.) at 0 degree boom angle (no load)					74

NOTE: () Boom angles are in degrees.

Boom Angle	35	55	61	74
0°	16,500 (28.2)	5,140 (47.4)	3,430 (53.8)	1,110 (66.6)

NOTE: () Reference radii in feet.

A6-829-015118

LIFTING OFF MAIN BOOM NOSE (35 FT. - 138 FT. BOOM) WITH:	
25 ft. Fly Section (Stowed on Boom Base Section)	440 lbs.
31 ft. Fixed Extension (Stowed on Boom Base Section)	1,110 lbs.
31 ft. Fixed Extension (Erected)	4,830 lbs.
31-56 ft. Folding Extension (Stowed on Boom Base Section)	1,550 lbs.
31-56 ft. Folding Extension (Erected)	10,700 lbs.
LIFTING OFF 31 FT. BOOM EXTENSION WITH:	
25 ft. Fly Section (Stowed on Boom Base Section)	440 lbs.
25 ft. Fly Section (Erected)	Not Permitted
25 ft. Fly Section (Stowed on 31 ft. Extension)	Not Permitted

*Reduction of main boom capacities

AUXILIARY BOOM NOSE	127 lbs.
HOOKBLOCKS and HEADACHE BALLS:	
65 Ton, 6 Sheave w/cheekplates	1,910 lbs.+
65 Ton, 6 Sheave w/o cheekplates	1,574 lbs.+
45 Ton, 3 Sheave w/cheekplates	977 lbs.+
45 Ton, 3 Sheave w/o cheekplates	830 lbs. +
15 Ton, 1 Sheave	420 lbs. +
10 Ton Headache Ball	560 lbs.+

+Refer to rating plate for actual weight.

THIS CHART IS ONLY A GUIDE AND SHOULD NOT BE USED TO OPERATE THE CRANE. The individual crane's load chart, operating instructions and other instructional plates must be read and understood prior to operating the crane.

Rated Lifting Capacities





































IMPORTANT NOTES:

WARNING: THIS CHART IS ONLY A GUIDE.

The notes below are for illustration only and should not be relied upon to operate the crane. The individual crane's load chart, operating instructions and other instruction plates must be read and understood prior to operating the crane.

1. All rated loads have been tested to and meet minimum requirements of SAE J1063 NOV93- Cantilevered Boom Crane Structures - Method of Test, and do not exceed 85% of the tipping load on outriggers fully extended and SAE J1289 APR81- Mobile Crane Stability Ratings [1.25P < (T-0.1A)] on outriggers 50% and 0% extended, (fully retracted), and 75% of the tipping load on rubber as determined by SAE J765 OCT90 Crane Stability Test Code.
2. Capacities given do not include the weight of hookblocks, slings, auxiliary lifting equipment and load handling devices. Their weights must be added to the load to be lifted. When more than minimum required reeving is used, the additional rope weight shall be considered part of the load.
3. Defined Arc $\pm 6^\circ$ on either side of longitudinal centerline of machine.
4. Capacities appearing above the bold line are based on structural strength. Tipping should never be used to determine capacity limitation.
5. All capacities are for crane on firm, level surface. It may be necessary to have structural supports under the outrigger floats or tires to spread the load to a larger bearing surface.
6. When either boom length or radius or both are between values listed, the smallest load shown at either the next larger radius or boom length shall be used.
7. Tires shall be inflated to the recommended pressure before lifting on rubber.
8. For outrigger operation, ALL outriggers shall be properly extended with tires raised free of ground before raising the boom or lifting loads.

Symbols Glossary

	Frame		Steering
	Outriggers		Transmission
	Outrigger Controls		Axles
	Engine		Brakes
	Fuel Tank Capacity		Tires
	Electrical System		Suspension
	Drive		Rotation
	Lights		Boom Elevation
	Cab		Swing
	Boom		Counterweight
	Fixed Swingaway		Oil
	Tele-Swingaway		Hydraulic System
	Jib		Hoist
	Boom Nose		Radius
	Boom Extension		Boom Length
	Speed		Hookblock
	Grade		Gear
	Lattice Extension		Luffing Jib



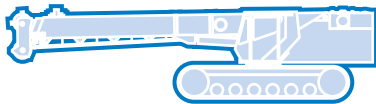
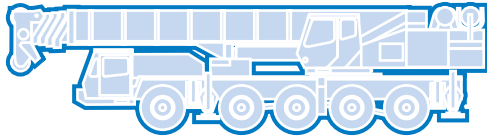

GROVE
worldwide

Grove Worldwide – World Headquarters

Grove North America
1565 Buchanan Trail East
P.O. Box 21
Shady Grove, Pennsylvania 17256, U.S.A.
Tel: [Int + 1] (717) 597-8121
Fax: [Int + 1] (717) 597-4062
Western Hemisphere, Asia/Pacific

Grove Europe Limited*

Sunderland SR4 6TT, England
Tel: [Int + 44] 191 565-6281
Fax: [Int + 44] 191 564-0442
Europe, Africa, Middle East

Grove Europe Limited*

P.O. Box No. 268
4A Kimber Road
Abingdon, Oxfordshire, OX141SG
Tel: [Int + 44] 1235 55-3184
Fax: [Int + 44] 1235 55-3218

Deutsche Grove GmbH

Sales and Service
Helmholtzstrasse 12, Postfach 5026
D-40750 Langenfeld, Germany
Tel: [Int + 49] (2173) 8909-0
Fax: [Int + 49] (2173) 8909-30

Wilhelmshaven Works

Industriegelände West, Postfach 1853
D-26358 Wilhelmshaven, Germany
Tel: [Int + 49] (4421) 294-0
Fax: [Int + 49] (4421) 294-301

Grove France S.A.

16, chaussée Jules-César, 95520 OSNY
B.P. 203, 95523 CERGY PONTOISE CEDEX
France
Tel: [Int + 33] (1) 30313150
Int: [Int + 33] (1) 30386085

*Grove Europe Limited, Registered in England,
Number 1845128, Registered office, Crown Works,
Pallion, Sunderland, Tyne & Wear, England SR4 6TT

Grove Asia/Pacific - Regional Office

171 Chin Swee Road
#06-01 San Centre
Singapore 0316
Tel: [Int + 65] 536-6112
Fax: [Int + 65] 536-6119
Asia/Pacific, Near East

Grove China - Representative Office

Beijing Hotel Room 6074
No. 33 East Chang An Avenue
Beijing, 100004, China
Tel: [Int + 86] (10) 513-7766
Fax: [Int + 86] (10) 513-7307

Grove Product Support

Western Hemisphere, Asia/Pacific
1086 Wayne Avenue
Chambersburg, Pennsylvania USA
Tel: [Int + 1] (717) 263-5100
Fax: [Int + 1] (717) 267-0404

Europe, Africa, Middle East
Sunderland SR4 6TT, England
Tel: [Int + 44] 191 565-6281
Parts Fax: [Int + 44] 191 510-9242
Service Fax: [Int + 44] 191 510-9560

Constant improvement and engineering progress make it necessary that we reserve the right to make specification, equipment, and price changes without notice. Illustrations shown may include optional equipment and accessories and may not include all standard equipment.

Distributed By:

Bigge Crane and Rigging Co.

10700 Bigge Avenue
San Leandro, CA 94577
Phone: (888) 337-BIGGE or (510) 638-8100
Fax: (510) 639-4053
Email: info@bigge.com
Web site: www.bigge.com

Form No.: RT865BXL Part No.: 3-968 597-8M Printed in U.S.A.

