

 **TEREX CRANES**

**TEREX**  
**MODEL NO.**  
**RT 450**  
**HYDRAULIC CRANE**  
**50 TON**

P.C.S.A. CLASS 10 - 176

**LOAD RATINGS**

Do not operate this crane unless  
you have read and understood the  
information in this book.

This book must contain 31 pages.

**DO NOT REMOVE THIS BOOK  
FROM THE CRANE**

Part No. 12262-1113B



## INFORMATIONAL DATA

### HOIST TACKLE CHART

This chart only represents the maximum permissible hoist line load per parts of line. You must refer to the proper lift charts for machine rated loads.

MAXIMUM PERMISSIBLE HOIST LINE LOAD										
LINE PARTS	1	2	3	4	5	6	7	8	9	10
STD. HOIST	10,000	20,000	30,000	40,000	50,000	60,000	70,000	80,000	90,000	100,000
OPT. HOIST	9,080	18,160	27,240	36,320	45,400	54,480	65,560	70,000	81,270	90,000
AUX. HOIST	7,400	14,800	22,200	29,600	37,000	44,400	51,800	59,200	66,600	74,000
WIRE ROPE: 5/8" ROTATION RESISTANT COMPACTED STRAND, 18X19 OR 19X19 MINIMUM BREAKING STRENGTH - 22.7 TONS  5/8" 6X19 OR 6X37 IWRC IPS PERFORMED RIGHT REGULAR LAY MINIMUM BREAKING STRENGTH - 17.9 TONS					AUX. HOIST LINE: STD-1/2" 6X19 OR 6X37 CLASS IWRC, REG LAY PREFORMED WIRE ROPE MINIMUM BREAKING STRENGTH - 13.3 TONS  OPT - 9/16" ROTATION RESISTANT COMPACTED STRAND, 16X19 IR 19X19 MINIMUM BREAKING STRENGTH - 18.5 TONS					

### TIRE INFLATION CHART

RECOMMENDED TIRE PRESSURE				
TIRE SIZE	STATIONARY	CREEP	2 1/2 MPH	TRAVEL
21:00.X 25-28 PR	85 PSI	85 PSI	85 PSI	65 PSI
26:50 X 25-26 PR	65 PSI	65 PSI	65 PSI	50 PSI

### HOOK BLOCK WEIGHTS

HOOK BLOCK WEIGHTS	
HOOK & BALL _____	239 Lbs.
HOOK BLOCK (4 SHEAVE) _____	690 Lbs.
HOOK BLOCK (5 SHEAVE) _____	888 Lbs.
HOOK BLOCK (6 SHEAVE) _____	913 Lbs.

DIMENSIONS ARE FOR LARGEST KOEHRING FURNISHED HOOK BLOCK AND HEADACHE BALL. WITH ANTI-TWO BLOCK ACTIVATED.

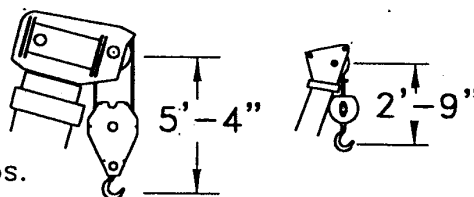

### MACHINE EQUIPMENT

1. COUNTERWEIGHT :  
 W/AUX. WINCH .....13100 Lbs.  
 W/O AUX. WINCH.....14200 Lbs
2. OUTRIGGER SPREAD 22ft - 0in. from center of outrigger float to center of outrigger float across the longitudinal axis of the machine.
3. Powered boom length 33.15ft. retracted to 105.15ft. extended.
4. Crane height 11ft.-11in., length 41ft.-9in., width 9ft.-10in., Wheelbase 12ft-6.5in.

### CLAMSHELL, MAGNET, AND CONCRETE BUCKET SERVICE

1. Maximum boom length for clamshell and magnet service is 50 feet.
2. Weight of clamshell or magnet, plus contents are not to exceed 6,000 pounds or 90% of rated lifting capacities, whichever is less. For concrete bucket operation, weight of bucket and load must not exceed 90% of rated lifting capacity.

### OUTRIGGER PAD LOADS

1. When lifting loads shown in these capacity charts, no single pad load will exceed 65,250 Lb.



# BASIC DIMENSIONS

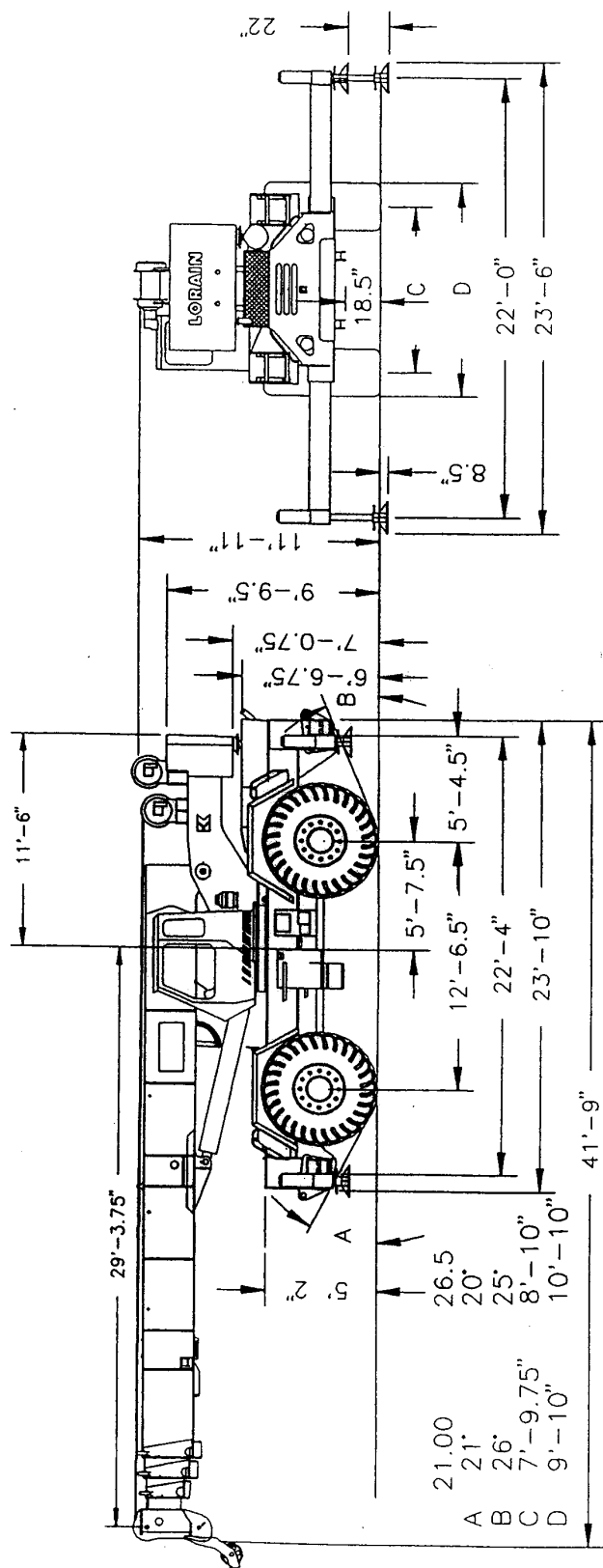

- A 21.00
- B 21'
- C 26'
- D 7'-9.75"
- 26.5
- 20'
- 25'
- 8'-10"
- 10'-10"

# WARNING

## GENERAL

1. Rated loads as shown on Lift Charts pertain to this machine as originally manufactured and equipped. Modifications to the machine or use of optional equipment other than that specified can result in a reduction of capacity.
2. Construction equipment can be hazardous if improperly operated or maintained. Operation and maintenance of this machine shall be in compliance with the information in the Operator's, Parts, and Safety Manuals supplied with this machine. If these manuals are missing, order replacements from the manufacturer through your distributor.
3. These warnings do not constitute all of the operating conditions for the crane. The operator and job site supervision must read the OPERATORS MANUAL, CIMA SAFETY MANUAL, APPLICABLE OSHA REGULATIONS AND SOCIETY OF MECHANICAL ENGINEERS (ASME) SAFETY STANDARDS FOR CRANES.
4. This crane and its load ratings are in accordance with POWER CRANE & SHOVEL ASSOCIATION, STANDARD NO. 4, SAE CRANE LOAD STABILITY TEST CODE J-765A, SAE METHOD OF TEST FOR CRANE STRUCTURE J1063 AND APPLICABLE SAFETY CODE FOR CRANES, DERRICKS AND HOIST, ASME/ANSI B30.5.

## DEFINITIONS

1. **LOAD RADIUS** – The horizontal distance from the axis of rotation before loading to the center of the vertical hoist line or tackle with a load applied.
2. **LOADED BOOM ANGLE** – It is the angle between the boom base section and the horizontal, after lifting the rated load at the rated radius. The boom angle before loading should be greater to account for deflections. The loaded boom angle combined with the boom length give only an approximation of the operating radius.
3. **WORKING AREA** – Areas measured in a circular arc about the centerline of rotation as shown in the diagram.
4. **FREELY SUSPENDED LOAD** – Load hanging free with no direct external force applied except by the hoist rope.
5. **SIDE LOAD** – Horizontal force applied to the lifted load either on the ground or in the air.
6. **NO LOAD STABILITY LIMIT** – The stability limit radius shown on the range diagrams is the radius beyond which it is not permitted to position the boom, when the boom angle is less than the minimum shown on the applicable load chart, because the machine can overturn without any load.

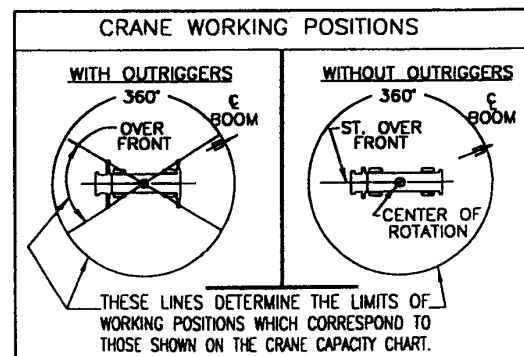



# WARNING

## SET-UP

1. Crane load ratings are based on the crane being leveled and standing on a firm, uniform supporting surface.
2. Crane load ratings on outriggers are based on all outrigger beams being fully extended, or in the case of partial extension ratings mechanically pinned in the appropriate position, and the tires free of the supporting surface.

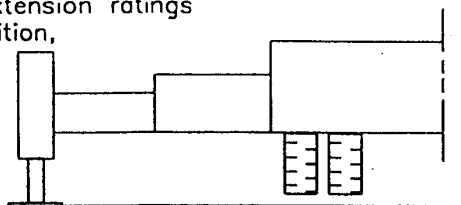

3. Crane load ratings on tires depend on appropriate inflation pressure and the tire conditions. Caution must be exercised when increasing air pressures in tires. Consult Operator's Manual for precautions.
4. Use of jibs, lattice-type boom extensions, or fourth section pullouts extended is not permitted for pick and carry operations.
5. Consult appropriate section of the Operator's and Service Manual for more exact description of hoist line reeving.
6. The use of more parts of line than required by the load may result in having insufficient rope to allow the hook block to reach the ground.
7. Properly maintained wire rope is essential for safe crane operation. Consult Operator's Manual for proper maintenance and inspection requirements.
8. When spin-resistant wire rope is used, the allowable rope loading shall be the breaking strength divided by five (5), unless otherwise specified by the wire rope manufacturer.

## OPERATION:

1. **CRANE LOAD RATINGS MUST NOT BE EXCEEDED. DO NOT ATTEMPT TO TIP THE CRANE TO DETERMINE ALLOWABLE LOADS.**
2. When either radius or boom length, or both, are between listed values, the smaller of the two listed load ratings shall be used.
3. Do not operate at longer radii than those listed on the applicable load rating chart (cross hatched  areas shown on range diagrams) as tipping can occur without a load on the hook.
4. The boom angles shown on the Capacity Chart give an approximation of the operating radius for a specified boom length. The boom angle, before loading, should be greater to account for boom deflection. It may be necessary to retract the boom if maximum boom angle is insufficient to maintain rated radius.
5. Power telescoping boom sections must be extended equally.



# **WARNING**

6. Rated loads include the weight of hook block, slings, and auxiliary lifting devices. Their weights shall be subtracted from the listed rated load to obtain the net load that can be lifted.

When lifting over the jib the weight of any hook block, slings, and auxiliary lifting devices at the boom head must be added to the load.

When jibs are erected but unused add two(2) times the weight of any hook block, slings, and auxiliary lifting devices at the jib head to the load.

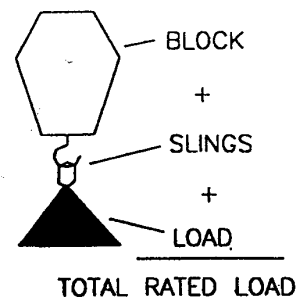

7. Rated loads do not exceed 85% on outriggers or 75% on tires, of the tipping load as determined by SAE Crane Stability Test Code J765a. Rated loads for partially extended outriggers are determined from the formula,  $\text{Rated Load} = (\text{Tipping Load} - 0.1 \times \text{Tip Reaction}) / 1.25$ . Structural strength ratings in chart are indicated with an asterisk (\*).
8. Rated loads are based on freely suspended loads. No attempt shall be made to drag a load horizontally on the ground in any direction.
9. The user shall operate at reduced ratings to allow for adverse job conditions, such as: Soft or uneven ground, out of level conditions, high winds, side loads, pendulum action, jerking or sudden stopping of loads, hazardous conditions, experience of personnel, two machine lifts, traveling with loads, electric wires, etc. (side pull on boom or jib is hazardous). Derating of the cranes lifting capacity is required when wind speed exceeds 20 MPH. The center of the lifted load must never be allowed to move more than 3 feet off the center line of the base boom section due to the effects of wind, inertia, or any combination of the two.  
 \*Use 2 feet off the center line of the base boom for a two section boom, 3 feet for a three section boom, or 4 feet for a four section boom.
10. The maximum load which can be telescoped is not definable, because of variations in loadings and crane maintenance, but it is permissible to attempt retraction and extension if load ratings are not exceeded.
11. Load ratings are dependent upon the crane being maintained according to manufacturer's specifications.
12. It is recommended that load handling devices, including hooks, and hook blocks, be kept away from boom head at all times.
13. FOR TRUCK CRANES ONLY: 360° capacities apply only to machines equipped with a front outrigger jack and all five (5) outrigger jacks properly set. If the front (5th) outrigger jack is not properly set, the work area is restricted to the over side and over rear areas as shown on the Crane Working Positions diagram. Use the 360° load ratings in the overside work areas.

USE THIS CHART ONLY WHEN ALL OUTRIGGERS ARE FULLY EXTENDED

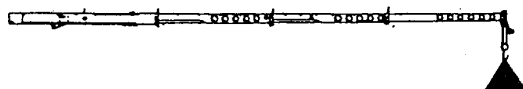
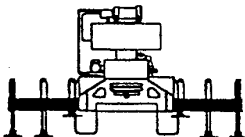

RATED LOAD ON OUTRIGGERS											
LOAD RADIUS (FT)	LOADED BOOM ANGLE (DEG)	OVER FRONT (LB)	360° (LB)	LOAD RADIUS (FT)	LOADED BOOM ANGLE (DEG)	OVER FRONT (LB)	360° (LB)	LOAD RADIUS (FT)	LOADED BOOM ANGLE (DEG)	OVER FRONT (LB)	360° (LB)
BOOM LENGTH 33.15 FT				BOOM LENGTH 45.15 FT				BOOM LENGTH 57.15 FT			
10.0	65.3	10000*	10000*	10.0	72.2	75000*	75000*				
12.0	61.5	76100*	76100*	12.0	69.5	73000*	73000*	12.0	73.9	59600*	59600*
15.0	55.4	64200*	62400*	15.0	65.4	61700*	61700*	15.0	70.8	55000*	55000*
20.0	44.0	46200*	44200*	20.0	58.1	47100*	45100*	20.0	65.4	47600*	45600*
25.0	29.6	34700*	33200*	25.0	50.3	35700*	34200*	25.0	59.7	36200*	34700*
29.3	0.0	17000*	17000*	30.0	41.5	28000*	26900*	30.0	53.7	28600*	27400*
				35.0	30.7	22600*	21600*	35.0	47.2	23100*	22200*
				40.0	13.9	18400*	17600*	40.0	39.9	19000*	18200*
				41.3	0.0	10600*	10600*	45.0	31.3	15800*	15100*
BOOM LENGTH 69.15 FT				BOOM LENGTH 81.15 FT				50.0	19.6	13200*	12600*
15.0	74.2	43900*	43900*					53.3	0.0	6800*	6800*
20.0	69.8	36100*	36100*	20.0	72.9	33400*	33400*	BOOM LENGTH 93.15 FT			
25.0	65.4	30300*	30300*	25.0	69.2	28300*	28300*	25.0	72.0	22100*	22100*
30.0	60.7	26000*	26000*	30.0	65.4	24200*	24200*	30.0	68.7	18900*	18900*
35.0	55.8	22700*	22500*	35.0	61.4	21000*	21000*	35.0	65.4	16200*	16200*
40.0	50.7	19400*	18600*	40.0	57.3	18600*	18600*	40.0	61.9	14200*	14200*
45.0	45.1	16200*	15500*	45.0	53.0	16400*	15700*	45.0	58.4	12300*	12300*
50.0	38.9	13700*	13000*	50.0	48.4	13900*	13300*	50.0	54.7	10800*	10800*
55.0	31.7	11400	10800	55.0	43.5	11600	10900	55.0	50.8	9600*	9600*
60.0	22.6	9400	8800	60.0	38.1	9600	9000	60.0	46.7	8600*	8600*
65.3	0.0	4400*	4400*	65.0	32.0	8000	7500	65.0	42.4	7700*	7600
BOOM LENGTH 105.15 FT				70.0	24.5	6600	6100	70.0	37.6	6800	6300
				75.0	13.7	5400	5000	75.0	32.2	5600	5200
30.0	71.2	15000*	15000*	77.3	0.0	2600*	2600*	80.0	25.8	4700	4300
35.0	68.3	13300*	13300*					85.0	17.5	3800	3400
40.0	65.4	11900*	11900*					89.3	0.0	1400*	1400*
45.0	62.3	10700*	10700*								
50.0	59.2	9500*	9500*								
55.0	56.0	8500*	8500*								
60.0	52.6	7500*	7500*								
65.0	49.1	6600*	6600*								
70.0	45.4	5900*	5900*								
75.0	41.4	5200*	5200*								
80.0	37.1	4600*	4400								
85.0	32.3	3900	3600								
90.0	26.8	3200	2800								
95.0	20.0	2500	2200								
100.0	9.1	1900	1600								
101.3	0.0	400*	400*								

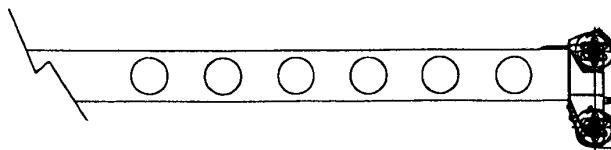

Add 100Lbs to the chart values if the AUX BOOM HEAD SHEAVE is NOT ERECTED.



**SET-UP:**

1. Crane load ratings are based on the crane being leveled and standing on a firm, uniform supporting surface.
2. Crane load ratings on outriggers are based on all outrigger beams being fully extended, or in the case of partial extension ratings mechanically pinned in the appropriate position, and the tires free of the supporting surface.

**OPERATION:**

1. CRANE LOAD RATINGS MUST NOT BE EXCEEDED. DO NOT ATTEMPT TO TIP THE CRANE TO DETERMINE ALLOWABLE LOADS.
2. When either radius or boom length, or both, are between listed values, the smaller of the two listed load ratings shall be used.
3. Do not operate at longer radii than those listed on the applicable load rating chart (cross hatched  areas shown on range diagrams) as tipping can occur without a load on the hook.
4. The boom angles shown on the Capacity Chart give an approximation of the operating radius for a specified boom length. The boom angle, before loading, should be greater to account for boom deflection. It may be necessary to retract the boom if maximum boom angle is insufficient to maintain rated radius.
5. Power telescoping boom sections must be extended equally.

**BOOM DEFLECTIONS NOT SHOWN**

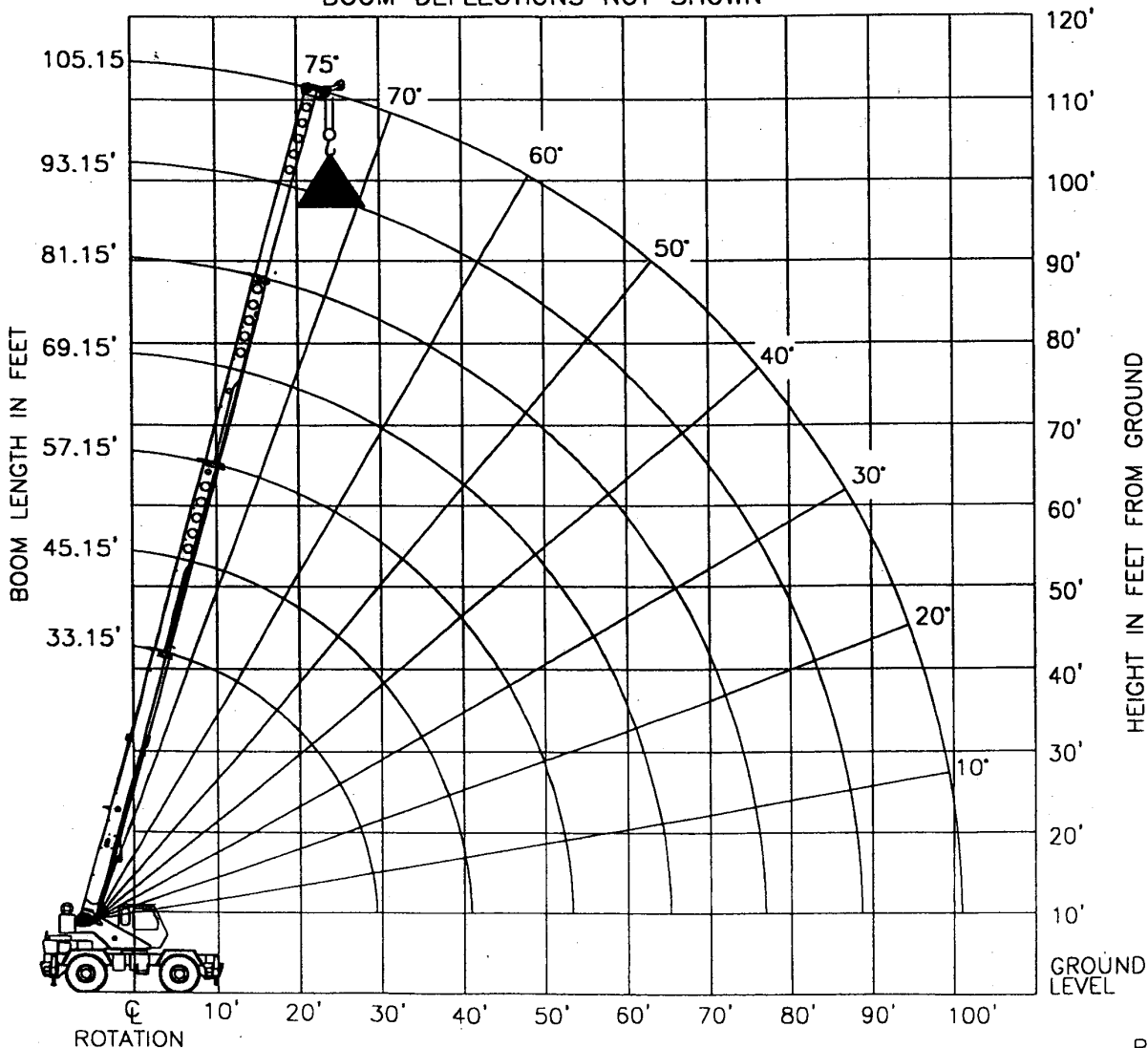

USE THIS CHART ONLY WHEN ALL OUTRIGGERS ARE FULLY EXTENDED

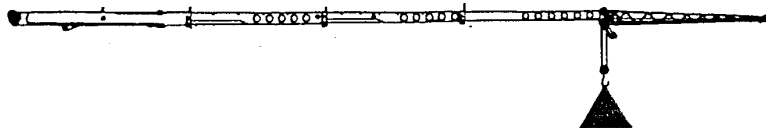
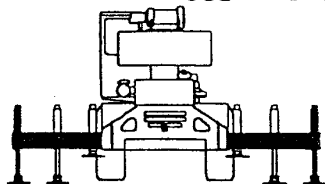

RATED LOAD ON OUTRIGGERS											
LOAD RADIUS (FT)	LOADED BOOM ANGLE (DEG)	OVER FRONT (LB)	360° (LB)	LOAD RADIUS (FT)	LOADED BOOM ANGLE (DEG)	OVER FRONT (LB)	360° (LB)	LOAD RADIUS (FT)	LOADED BOOM ANGLE (DEG)	OVER FRONT (LB)	360° (LB)
BOOM LENGTH 33.15 FT				BOOM LENGTH 45.15 FT				BOOM LENGTH 57.15 FT			
10.0	65.3	97500*	94800*	10.0	72.2	75000*	75000*				
12.0	61.5	76100*	76100*	12.0	69.5	73000*	73000*	12.0	73.9	59600*	59600*
15.0	55.4	62200*	59400*	15.0	65.4	61700*	60200*	15.0	70.8	55000*	55000*
20.0	44.0	43300*	41500*	20.0	58.1	44200*	42300*	20.0	65.4	44600*	42700*
25.0	29.6	32000*	30600*	25.0	50.3	32900*	31500*	25.0	59.7	33400*	31900*
29.3	0.0	14900*	14900*	30.0	41.5	25400*	24300*	30.0	53.7	25900*	24700*
				35.0	30.7	20000*	19100*	35.0	47.2	20500*	19600*
				40.0	13.9	15800*	15100*	40.0	39.9	16500*	15700*
				41.3	0.0	8400*	8400*	45.0	31.3	13300*	12600*
BOOM LENGTH 69.15 FT				BOOM LENGTH 81.15 FT				50.0	19.6	10800*	10100
								53.3	0.0	4600*	4600*
15.0	74.2	43900*	43900*					BOOM LENGTH 93.15 FT			
20.0	69.8	36100*	36100*	20.0	72.9	33400*	33400*				
25.0	65.4	30300*	30300*	25.0	69.2	28300*	28300*	25.0	72.0	22100*	22100*
30.0	60.7	26000*	25000*	30.0	65.4	24200*	24200*	30.0	68.7	18900*	18900*
35.0	55.8	20800*	19900*	35.0	61.4	21000*	20100*	35.0	65.4	16200*	16200*
40.0	50.7	16800*	16000*	40.0	57.3	17000*	16200*	40.0	61.9	14200*	14200*
45.0	45.1	13600*	13000*	45.0	53.0	13800*	13200*	45.0	58.4	12300*	12300*
50.0	38.9	11100*	10500	50.0	48.4	11300*	10700	50.0	54.7	10800*	10800*
55.0	31.7	8800	8100	55.0	43.5	9000	8400	55.0	50.8	9200	8500
60.0	22.6	6800	6200	60.0	38.1	7100	6500	60.0	46.7	7200	6700
65.3	0.0	2200*	2200*	65.0	32.0	5500	4900	65.0	42.4	5600	5100
BOOM LENGTH 105.15 FT				70.0	24.5	4100	3700	70.0	37.6	4300	3900
				75.0	13.7	3000	2500	75.0	32.2	3200	2800
30.0	71.2	15000*	15000*	77.3	0.0	400*	400*	80.0	25.8	2200	1800
35.0	68.3	13300*	13300*					85.0	17.5	1400	1000
40.0	65.4	11900*	11900*								
45.0	62.3	10700*	10700*								
50.0	59.2	9500*	9500*								
55.0	56.0	8500*	8500*								
60.0	52.6	7300	6800								
65.0	49.1	5800	5200								
70.0	45.4	4400	4000								
75.0	41.4	3300	2900								
80.0	37.1	2400	2000								
85.0	32.3	1500	1200								

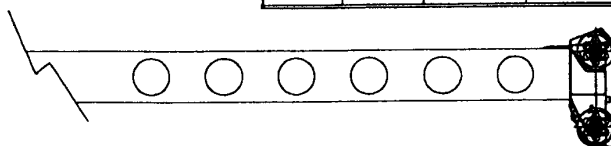

Add 100Lbs to the chart values if the AUX BOOM HEAD SHEAVE is NOT ERECTED.

**SET-UP:**

1. Crane load ratings are based on the crane being leveled and standing on a firm, uniform supporting surface.
2. Crane load ratings on outriggers are based on all outrigger beams being fully extended, or in the case of partial extension ratings mechanically pinned in the appropriate position, and the tires free of the supporting surface.

**OPERATION:**

1. CRANE LOAD RATINGS MUST NOT BE EXCEEDED. DO NOT ATTEMPT TO TIP THE CRANE TO DETERMINE ALLOWABLE LOADS.
2. When either radius or boom length, or both, are between listed values, the smaller of the two listed load ratings shall be used.
3. Do not operate at longer radii than those listed on the applicable load rating chart (cross hatched  areas shown on range diagrams) as tipping can occur without a load on the hook.
4. The boom angles shown on the Capacity Chart give an approximation of the operating radius for a specified boom length. The boom angle, before loading, should be greater to account for boom deflection. It may be necessary to retract the boom if maximum boom angle is insufficient to maintain rated radius.
5. Power telescoping boom sections must be extended equally.

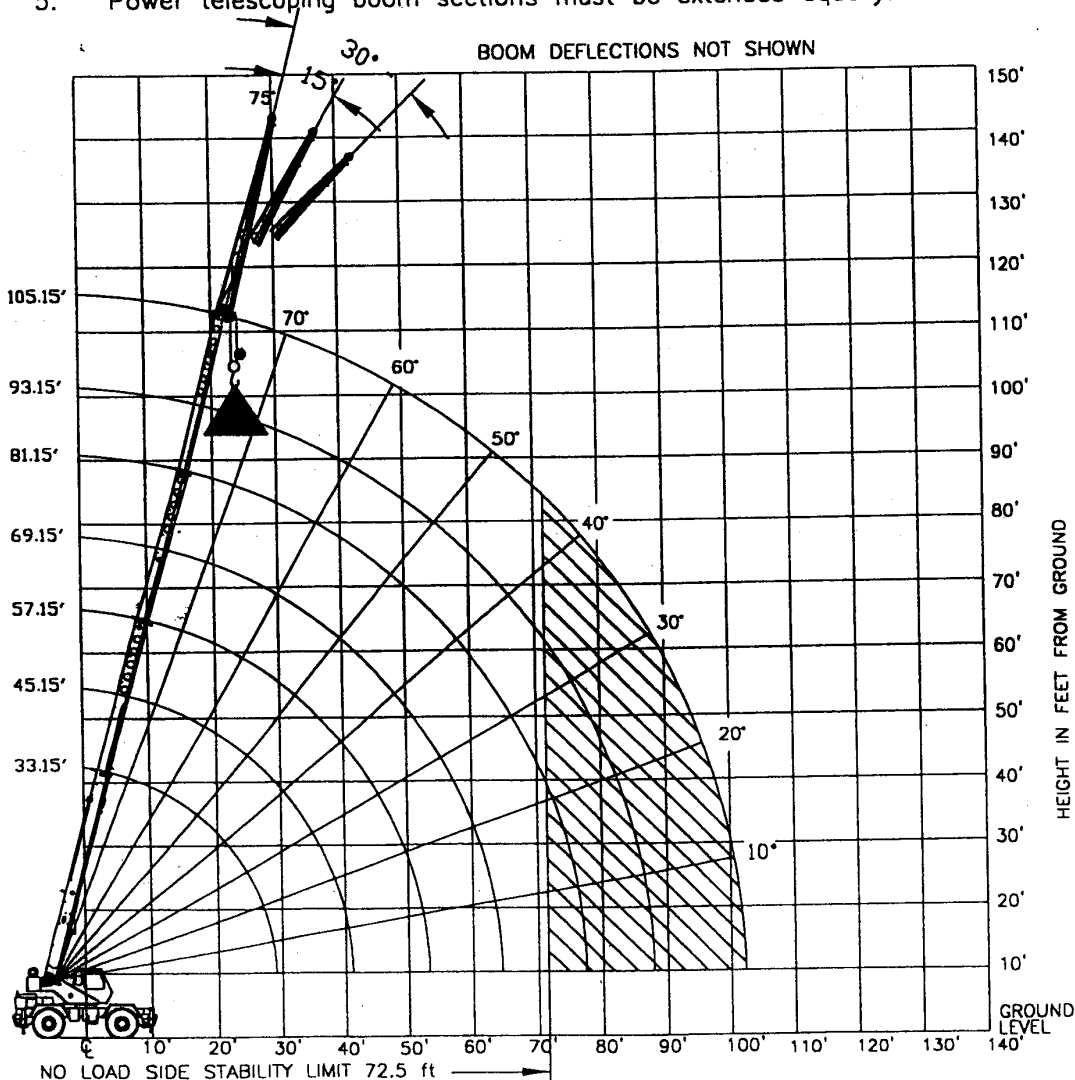

USE THIS CHART ONLY WHEN ALL OUTRIGGERS ARE FULLY EXTENDED

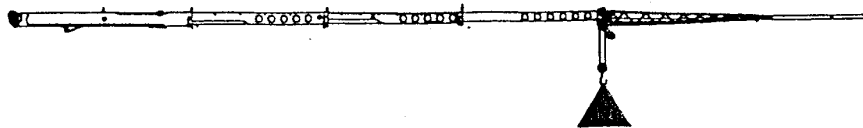
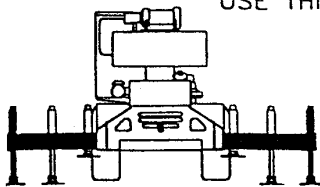

RATED LOAD ON OUTRIGGERS											
LOAD RADIUS (FT)	LOADED BOOM ANGLE (DEG)	OVER FRONT (LB)	360° (LB)	LOAD RADIUS (FT)	LOADED BOOM ANGLE (DEG)	OVER FRONT (LB)	360° (LB)	LOAD RADIUS (FT)	LOADED BOOM ANGLE (DEG)	OVER FRONT (LB)	360° (LB)
BOOM LENGTH 33.15 FT				BOOM LENGTH 45.15 FT				BOOM LENGTH 57.15 FT			
10.0	65.3	96900*	94000*	10.0	72.2	75000*	75000*				
12.0	61.5	76100*	76100*	12.0	69.5	73000*	73000*	12.0	73.9	59600*	59600*
15.0	55.4	61400*	58600*	15.0	65.4	61700*	59600*	15.0	70.8	55000*	55000*
20.0	44.0	42600*	40700*	20.0	58.1	43700*	41800*	20.0	65.4	44200*	42300*
25.0	29.6	31300*	29900*	25.0	50.3	32400*	31000*	25.0	59.7	33000*	31500*
29.3	0.0	14300*	14300*	30.0	41.5	24900*	23800*	30.0	53.7	25500*	24300*
				35.0	30.7	19500*	18600*	35.0	47.2	20100*	19200*
				40.0	13.9	15400*	14600*	40.0	39.9	16100*	15300*
				41.3	0.0	8000*	8000*	45.0	31.3	12900*	12200*
BOOM LENGTH 69.15 FT				BOOM LENGTH 81.15 FT				50.0	19.6	10300	9700
								53.3	0.0	4300*	4300*
15.0	74.2	43900*	43900*					BOOM LENGTH 93.15 FT			
20.0	69.8	36100*	36100*	20.0	72.9	33400*	33400*				
25.0	65.4	30300*	30300*	25.0	69.2	28300*	28300*	25.0	72.0	22100*	22100*
30.0	60.7	25800*	24700*	30.0	65.4	24200*	24200*	30.0	68.7	18900*	18900*
35.0	55.8	20500*	19500*	35.0	61.4	20700*	19800*	35.0	65.4	16200*	16200*
40.0	50.7	16500*	15700*	40.0	57.3	16700*	15900*	40.0	61.9	14200*	14200*
45.0	45.1	13300*	12600*	45.0	53.0	13600*	12900*	45.0	58.4	12300*	12300*
50.0	38.9	10700	10200*	50.0	48.4	11000	10500*	50.0	54.7	10800*	10700*
55.0	31.7	8300	7900	55.0	43.5	8600	8200	55.0	50.8	8800	8400
60.0	22.6	6400	6000	60.0	38.1	6700	6300	60.0	46.7	6900	6500
65.3	0.0	1900*	1900*	65.0	32.0	5100	4800	65.0	42.4	5400	5000
BOOM LENGTH 105.15 FT				70.0	24.5	3800	3500	70.0	37.6	4100	3700
				75.0	13.7	2700	2400	75.0	32.2	3000	2700
30.0	71.2	15000*	15000*	77.3	0.0	200*	200*	80.0	25.8	2000	1800
35.0	68.3	13300*	13300*					85.0	17.5	1200	900
40.0	65.4	11900*	11900*								
45.0	62.3	10700*	10700*								
50.0	59.2	9500*	9500*								
55.0	56.0	8500*	8500*								
60.0	52.6	7100	6700								
65.0	49.1	5500	5200								
70.0	45.4	4200	3900								
75.0	41.4	3100	2800								
80.0	37.1	2200	1900								
85.0	32.3	1400	1100								

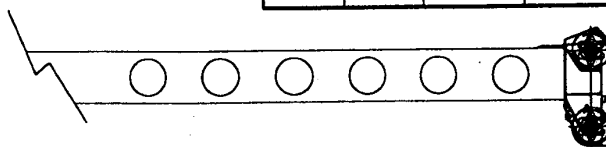

Add 100lbs to the chart values if the AUX BOOM HEAD SHEAVE is NOT ERECTED.



**SET-UP:**

1. Crane load ratings are based on the crane being leveled and standing on a firm, uniform supporting surface.
2. Crane load ratings on outriggers are based on all outrigger beams being fully extended, or in the case of partial extension ratings mechanically pinned in the appropriate position, and the tires free of the supporting surface.

**OPERATION:**

1. CRANE LOAD RATINGS MUST NOT BE EXCEEDED. DO NOT ATTEMPT TO TIP THE CRANE TO DETERMINE ALLOWABLE LOADS.
2. When either radius or boom length, or both, are between listed values, the smaller of the two listed load ratings shall be used.
3. Do not operate at longer radii than those listed on the applicable load rating chart (cross hatched  areas shown on range diagrams) as tipping can occur without a load on the hook.
4. The boom angles shown on the Capacity Chart give an approximation of the operating radius for a specified boom length. The boom angle, before loading, should be greater to account for boom deflection. It may be necessary to retract the boom if maximum boom angle is insufficient to maintain rated radius. BOOM DEFLECTION NOT SHOWN
5. Power telescoping boom sections must be extended equally.

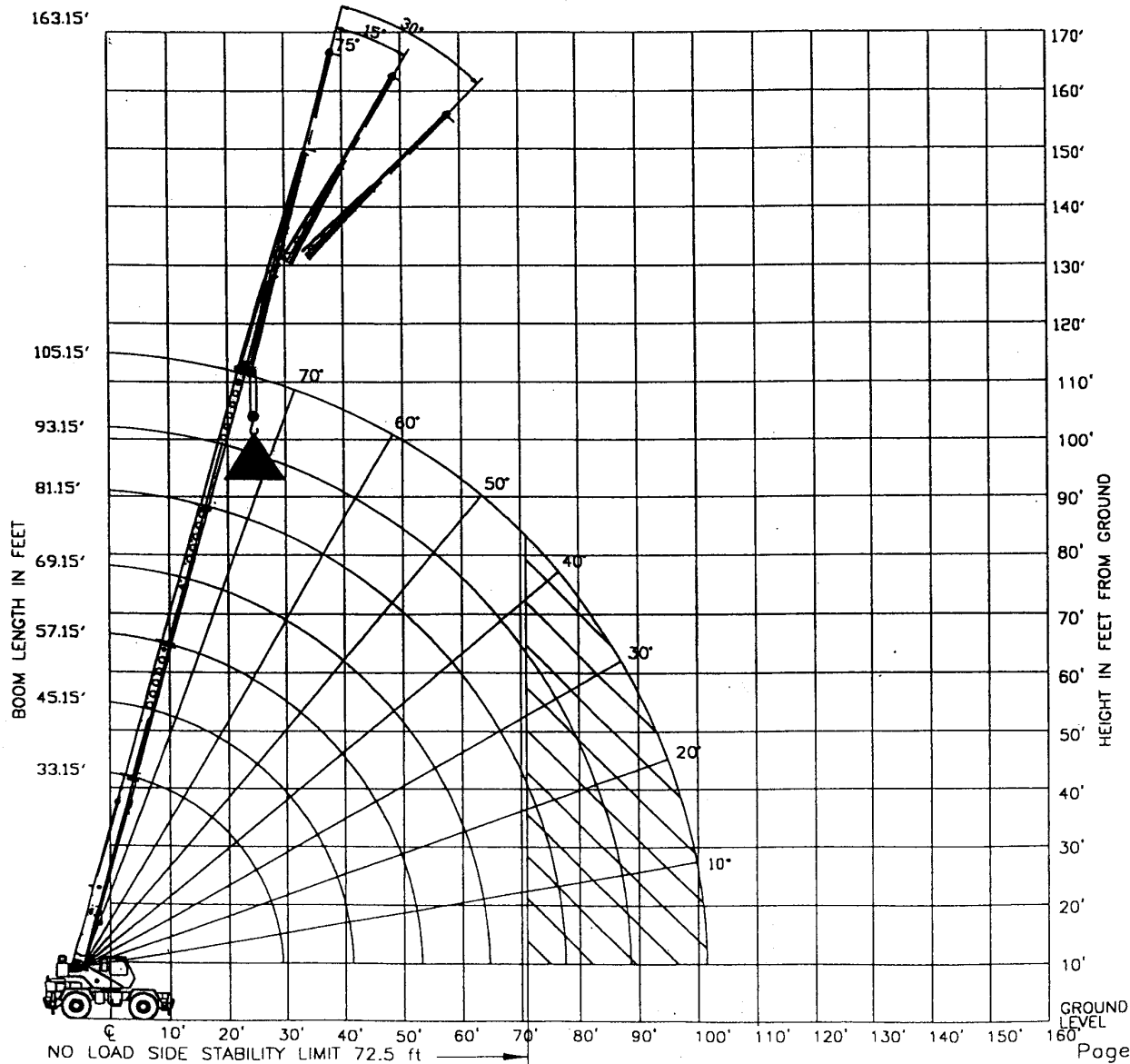

USE THIS CHART ONLY WHEN ALL OUTRIGGERS ARE FULLY EXTENDED  
 USE THIS CHART ONLY WHEN NO PULL OUT IS INSTALLED IN JIB

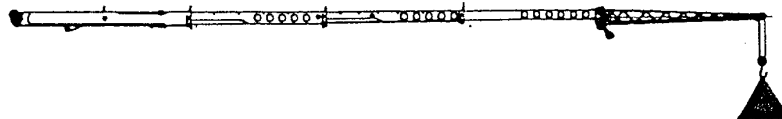
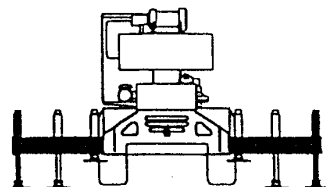

RATED LOAD ON OUTRIGGERS WITH 33 FT OFFSETABLE JIB						
LOADED BOOM ANGLE (DEG)	0° OFFSET		15° OFFSET		30° OFFSET	
	LOAD RADIUS (REF) (FT)	360° (LB)	LOAD RADIUS (REF) (FT)	360° (LB)	LOAD RADIUS (REF) (FT)	360° (LB)
75	38'	9000*	46'	7200*	52'	6000*
73	43'	7700*	50'	6600*	57'	5500*
70	50'	7500*	56'	6300*	63'	5400*
67	57'	7300*	63'	5900*	69'	5100*
64	63'	6300*	69'	5200*	75'	4600*
61	70'	5500*	76'	4700*	81'	4100*
58	76'	4900*	81'	4200*	86'	3700*
54	83'	4200*	88'	3700*	93'	3300*
50	90'	3700*	95'	3200*	99'	3000*
46	97'	3200*	101'	2800*	105'	2600*
42	103'	2800*	107'	2600*	110'	2400*
38	109'	2100	112'	1900	115'	1700
32	117'	1400	116'	1300	121'	1300

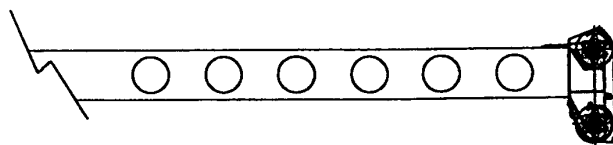

Add 100Lbs to the chart values if the AUX BOOM HEAD SHEAVE is NOT ERECTED.

**SET-UP:**

1. Crane load ratings are based on the crane being leveled and standing on a firm, uniform supporting surface.
2. Crane load ratings on outriggers are based on all outrigger beams being fully extended, or in the case of partial extension ratings mechanically pinned in the appropriate position, and the tires free of the supporting surface.



**OPERATION:**

1. CRANE LOAD RATINGS MUST NOT BE EXCEEDED. DO NOT ATTEMPT TO TIP THE CRANE TO DETERMINE ALLOWABLE LOADS.
2. When either radius or boom angle, or both, are between listed values, the smaller of the two listed load ratings shall be used.
3. Do not operate at longer radii than those listed on the applicable load rating chart (cross hatched  areas shown on range diagrams) as tipping can occur without a load on the hook.
4. The boom angles shown on the Capacity Chart give an approximation of the operating radius for a fully extended boom. The boom angle, before loading, should be greater to account for boom deflection. It may be necessary to retract the boom if maximum boom angle is insufficient to maintain rated radius.
5. Power telescoping boom sections must be extended equally.
6. For all boom lengths less than the maximum with the jib erected, the rated loads are determined by boom angle only in the appropriate column.
7. For boom angles not shown, use the capacity of the next lower angle.
8. Listed radii are for fully extended boom only.

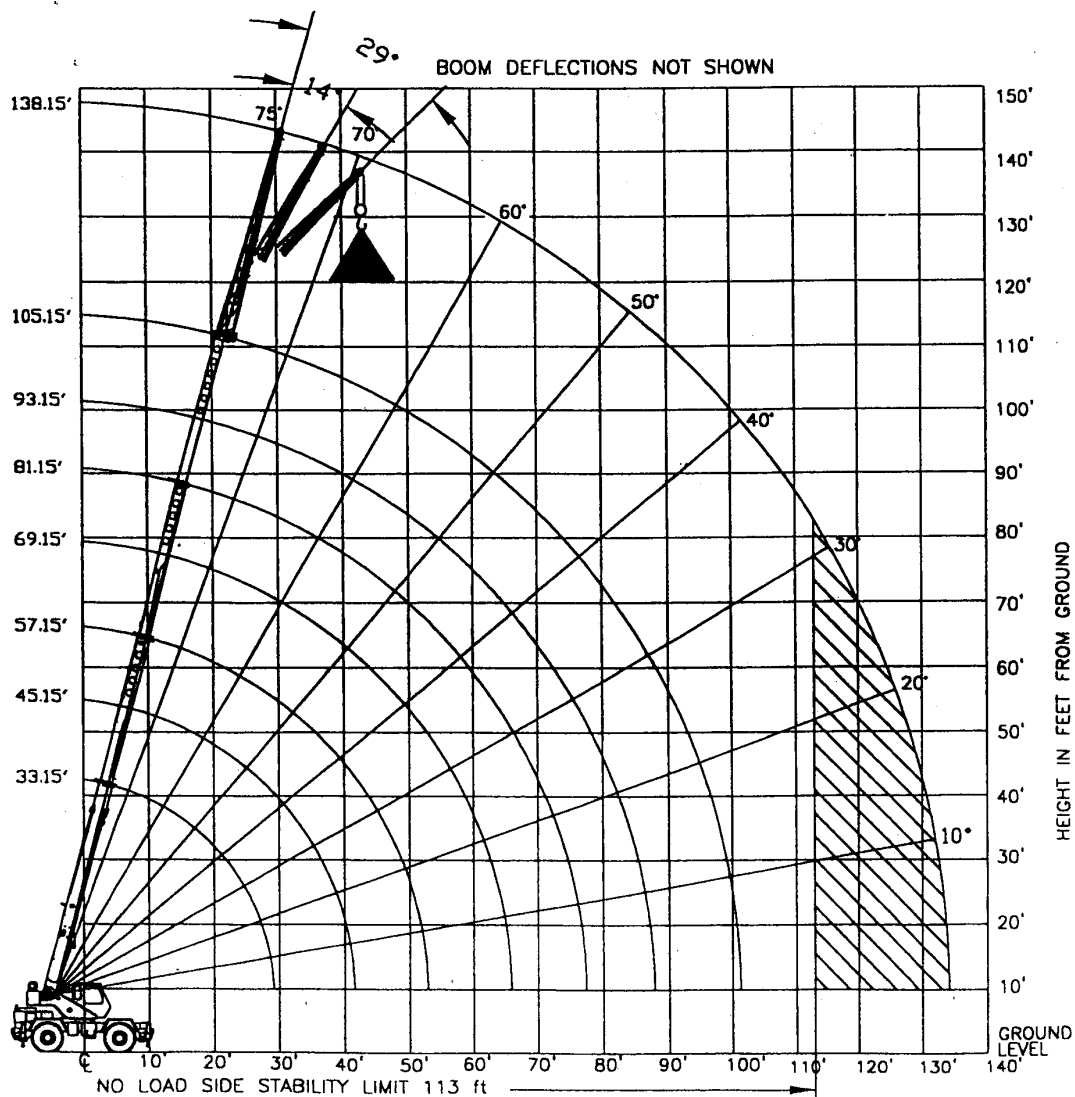

USE THIS CHART ONLY WHEN ALL OUTRIGGERS ARE FULLY EXTENDED  
 USE THIS CHART THE JIB'S PULL OUT IS RETRACTED

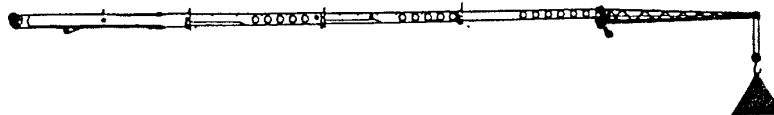
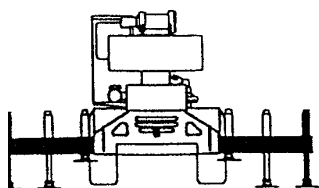

RATED LOAD ON OUTRIGGERS WITH 33 FT OFFSETABLE JIB

LOADED BOOM ANGLE (DEG)	0° OFFSET		15° OFFSET		30° OFFSET	
	LOAD RADIUS (REF) (FT)	360° (LB)	LOAD RADIUS (REF) (FT)	360° (LB)	LOAD RADIUS (REF) (FT)	360° (LB)
75	38'	9000*	46'	7200*	52'	6000*
73	43'	7700*	50'	6600*	57'	5500*
70	50'	7300*	56'	5900*	63'	5000*
67	57'	6700*	63'	5400*	69'	4600*
64	63'	5700*	69'	4700*	75'	4000*
61	70'	4900*	76'	4100*	81'	3600*
58	76'	4200*	81'	3600*	86'	3200*
54	83'	3500*	88'	3000*	93'	2700*
50	90'	3000*	95'	2600*	99'	2400*
46	97'	2500*	101'	2200*	105'	2000*
42	103'	2100*	107'	1900*	110'	1800*
38	109'	1400	112'	1300	115'	1300

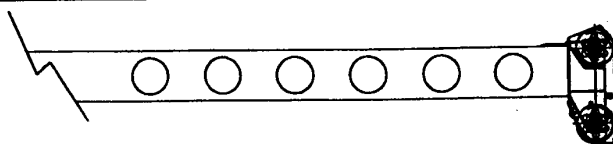

Add 100lbs to the chart values if the AUX BOOM HEAD SHEAVE is NOT ERECTED.

SET-UP:

1. Crane load ratings are based on the crane being leveled and standing on a firm, uniform supporting surface.
2. Crane load ratings on outriggers are based on all outrigger beams being fully extended, or in the case of partial extension ratings mechanically pinned in the appropriate position, and the tires free of the supporting surface.



**OPERATION:**

1. CRANE LOAD RATINGS MUST NOT BE EXCEEDED. DO NOT ATTEMPT TO TIP THE CRANE TO DETERMINE ALLOWABLE LOADS.
2. When either radius or boom angle, or both, are between listed values, the smaller of the two listed load ratings shall be used.
3. Do not operate at longer radii than those listed on the applicable load rating chart (cross hatched  areas shown on range diagrams) as tipping can occur without a load on the hook.
4. The boom angles shown on the Capacity Chart give an approximation of the operating radius for a fully extended boom. The boom angle, before loading, should be greater to account for boom deflection. It may be necessary to retract the boom if maximum boom angle is insufficient to maintain rated radius.
5. Power telescoping boom sections must be extended equally.
6. For all boom lengths less than the maximum with the jib erected, the rated loads are determined by boom angle only in the appropriate column.
7. For boom angles not shown, use the capacity of the next lower angle.
8. Listed radii are for fully extended boom only.

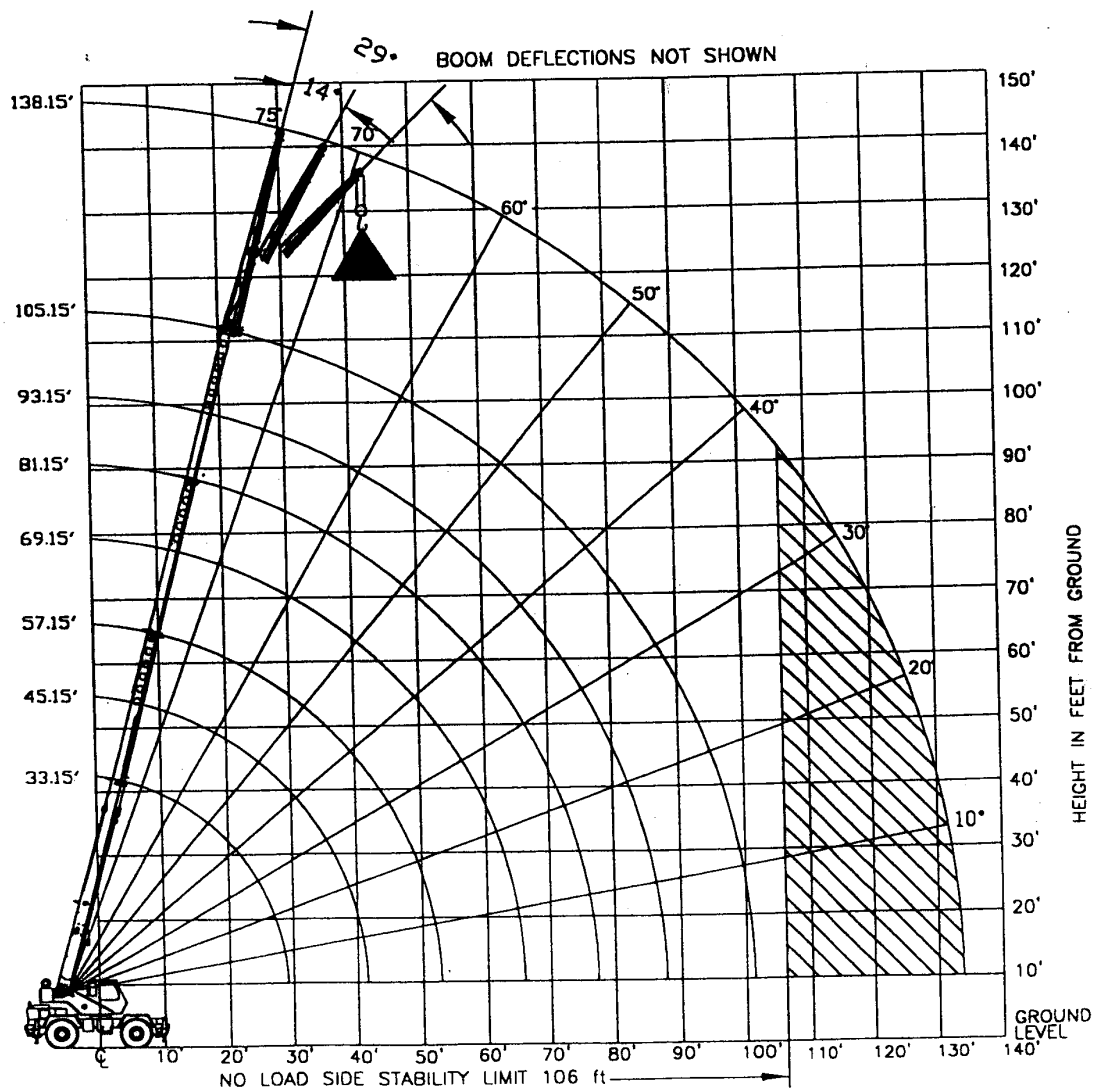

USE THIS CHART ONLY WHEN ALL OUTRIGGERS ARE FULLY EXTENDED

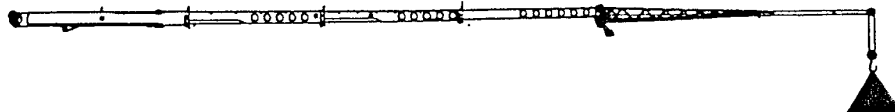
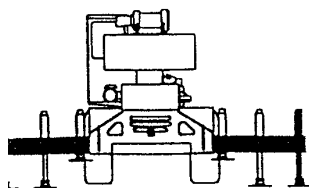

RATED LOAD ON OUTRIGGERS WITH 58 FT OFFSETABLE JIB						
LOADED BOOM ANGLE (DEG)	0° OFFSET		15° OFFSET		30° OFFSET	
	LOAD RADIUS (REF) (FT)	360° (LB)	LOAD RADIUS (REF) (FT)	360° (LB)	LOAD RADIUS (REF) (FT)	360° (LB)
75	50'	5000*	64'	4000*	75'	3300*
73	55'	4700*	69'	3800*	79'	3200*
70	63'	4500*	76'	3500*	86'	2900*
67	71'	4400*	83'	3200*	92'	2700*
64	78'	4300*	90'	2900*	98'	2500*
61	86'	3900*	97'	2800*	104'	2200*
58	93'	3500*	103'	2600*	110'	2200*
54	102'	3000*	111'	2500*	117'	2100*
50	110'	2600*	118'	2200*	123'	1900*
46	117'	1900	124'	1800	128'	1700*
42	123'	1300	130'	1200	133'	1200
38	129'	1000				

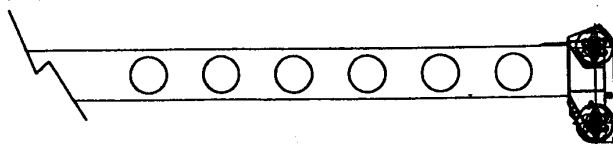

Add 100Lbs to the chart values if the AUX BOOM HEAD SHEAVE is NOT ERECTED.

SET-UP:

1. Crane load ratings are based on the crane being leveled and standing on a firm, uniform supporting surface.
2. Crane load ratings on outriggers are based on all outrigger beams being fully extended, or in the case of partial extension ratings mechanically pinned in the appropriate position, and the tires free of the supporting surface.



**SET-UP:**

1. Crane load ratings are based on the crane being leveled and standing on a firm, uniform supporting surface.
2. Crane load ratings on outriggers are based on all outrigger beams being fully extended, or in the case of partial extension ratings mechanically pinned in the appropriate position, and the tires free of the supporting surface.

**OPERATION:**

1. CRANE LOAD RATINGS MUST NOT BE EXCEEDED. DO NOT ATTEMPT TO TIP THE CRANE TO DETERMINE ALLOWABLE LOADS.
2. When either radius or boom length, or both, are between listed values, the smaller of the two listed load ratings shall be used.
3. Do not operate at longer radii than those listed on the applicable load rating chart (cross hatched  areas shown on range diagrams) as tipping can occur without a load on the hook.
4. The boom angles shown on the Capacity Chart give an approximation of the operating radius for a specified boom length. The boom angle, before loading, should be greater to account for boom deflection. It may be necessary to retract the boom if maximum boom angle is insufficient to maintain rated radius.
5. Power telescoping boom sections must be extended equally.

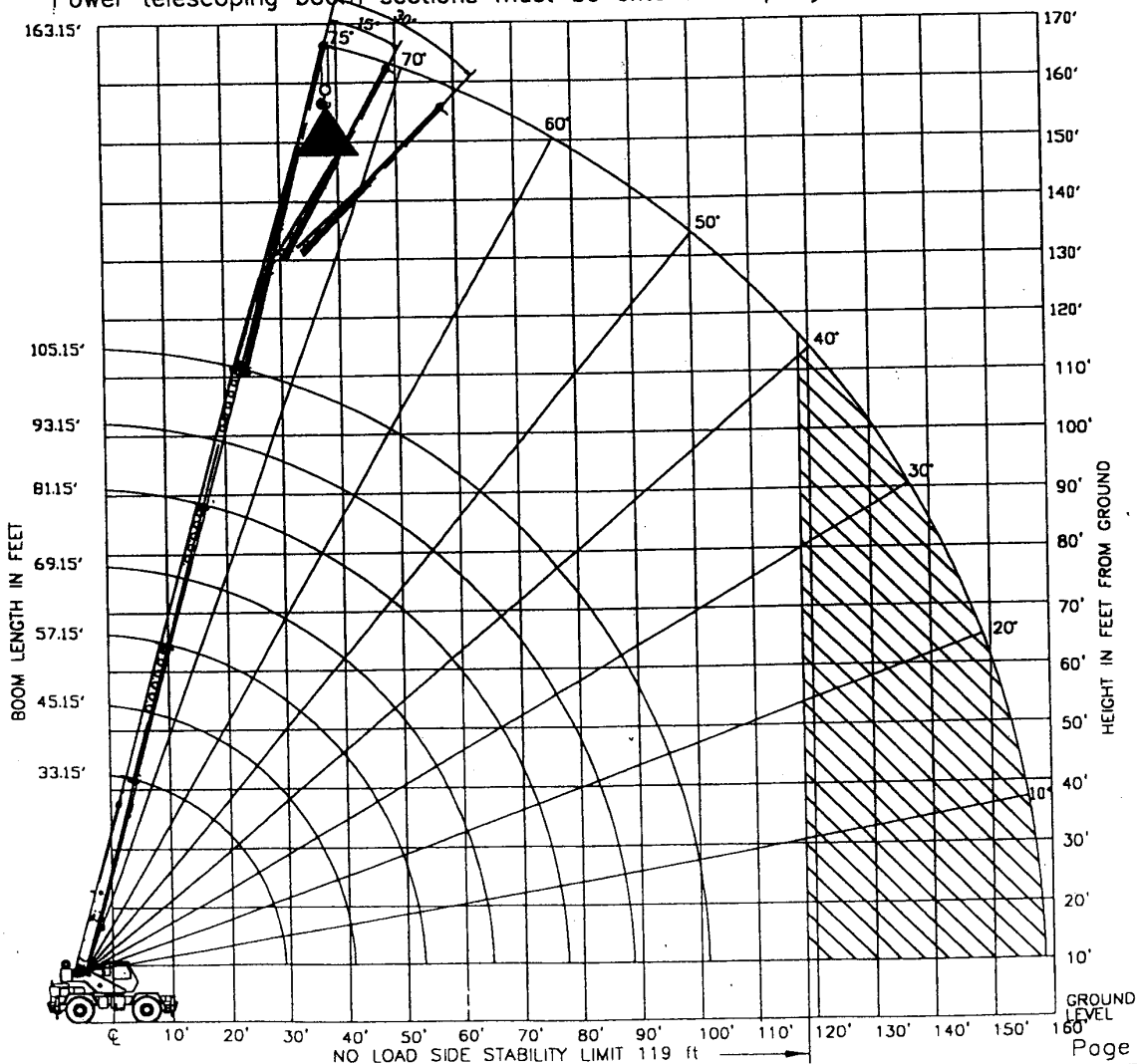

USE THIS CHART WHEN ALL OUTRIGGERS ARE PINNED IN THE MID POSITION

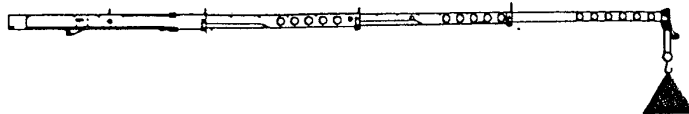
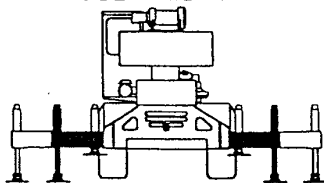

RATED LOAD ON OUTRIGGERS								
LOAD RADIUS (FT)	LOADED BOOM ANGLE (DEG)	360° (LB)	LOAD RADIUS (FT)	LOADED BOOM ANGLE (DEG)	360° (LB)	LOAD RADIUS (FT)	LOADED BOOM ANGLE (DEG)	360° (LB)
BOOM LENGTH 33.15 FT			BOOM LENGTH 45.15 FT			BOOM LENGTH 57.15 FT		
10.0	65.3	86900*	10.0	72.2	75000*			
12.0	61.5	70800*	12.0	69.5	71700*	12.0	73.9	59600*
15.0	55.4	54700*	15.0	65.4	55600*	15.0	70.8	55000*
20.0	44.0	38500*	20.0	58.1	39400*	20.0	65.4	39800*
25.0	29.6	25200	25.0	50.3	26300	25.0	59.7	26600
29.3	0.0	17000*	30.0	41.5	18500	30.0	53.7	18900
			35.0	30.7	13400	35.0	47.2	13900
			40.0	13.9	9700	40.0	39.9	10500
			41.3	0.0	8800	45.0	31.3	7900
BOOM LENGTH 69.15 FT			BOOM LENGTH 81.15 FT			50.0	19.6	5800
						53.3	0.0	4600
15.0	74.2	43900*				BOOM LENGTH 93.15 FT		
20.0	69.8	36100*	20.0	72.9	33400*			
25.0	65.4	26800	25.0	69.2	26900	25.0	72.0	22100*
30.0	60.7	19100	30.0	65.4	19200	30.0	68.7	18900*
35.0	55.8	14100	35.0	61.4	14300	35.0	65.4	14300
40.0	50.7	10700	40.0	57.3	10800	40.0	61.9	10900
45.0	45.1	8200	45.0	53.0	8400	45.0	58.4	8400
50.0	38.9	6200	50.0	48.4	6500	50.0	54.7	6500
55.0	31.7	4700	55.0	43.5	4900	55.0	50.8	5000
60.0	22.6	3400	60.0	38.1	3700	60.0	46.7	3800
65.3	0.0	2200	65.0	32.0	2600	65.0	42.4	2800
BOOM LENGTH 105.15 FT			70.0	24.5	1700	70.0	37.6	1900
						75.0	32.2	1200
30.0	71.2	15000*						
35.0	68.3	13300*						
40.0	65.4	11000						
45.0	62.3	8500						
50.0	59.2	6600						
55.0	56.0	5100						
60.0	52.6	3900						
65.0	49.1	2900						
70.0	45.4	2000						
75.0	41.4	1300						

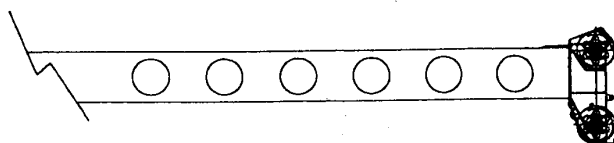

Add 100Lbs to the chart values if the AUX BOOM HEAD SHEAVE is NOT ERECTED.

**OPERATION:**

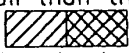
1. CRANE LOAD RATINGS MUST NOT BE EXCEEDED. DO NOT ATTEMPT TO TIP THE CRANE TO DETERMINE ALLOWABLE LOADS.
2. When either radius or boom angle, or both, are between listed values, the smaller of the two listed load ratings shall be used.
3. Do not operate at longer radii than those listed on the applicable load rating chart (cross hatched  areas shown on range diagrams) as tipping can occur without a load on the hook.
4. The boom angles shown on the Capacity Chart give an approximation of the operating radius for a fully extended boom. The boom angle, before loading, should be greater to account for boom deflection. It may be necessary to retract the boom if maximum boom angle is insufficient to maintain rated radius.
5. Power telescoping boom sections must be extended equally.
6. For all boom lengths less than the maximum with the jib erected, the rated loads are determined by boom angle only in the appropriate column.
7. For boom angles not shown, use the capacity of the next lower angle.
8. Listed radii are for fully extended boom only.

**BOOM DEFLECTIONS NOT SHOWN**

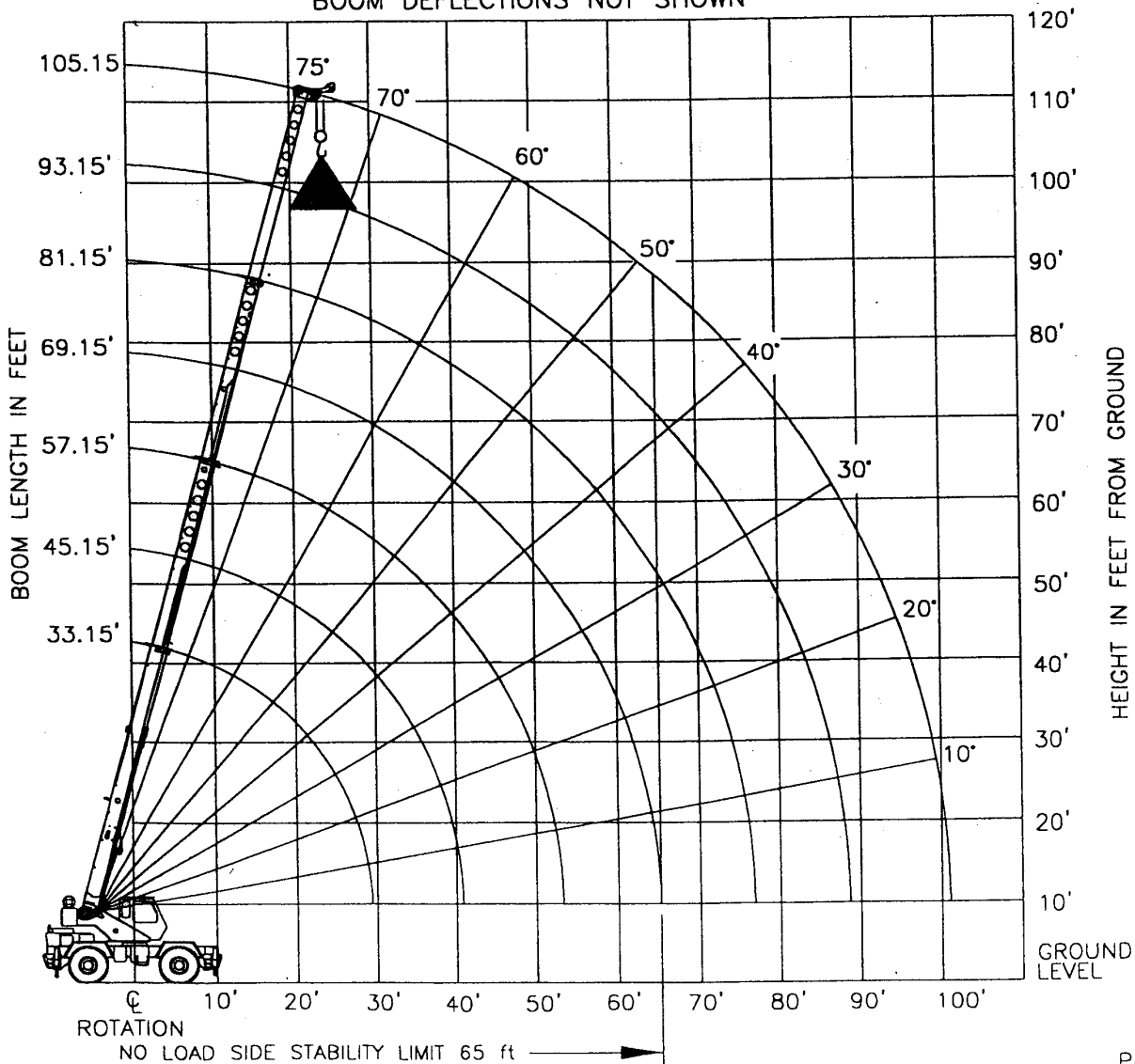

USE THIS CHART WHEN ALL OUTRIGGERS ARE PINNED IN THE MID POSITION  
 USE THIS CHART ONLY WHEN NO PULL OUT IS INSTALLED IN JIB

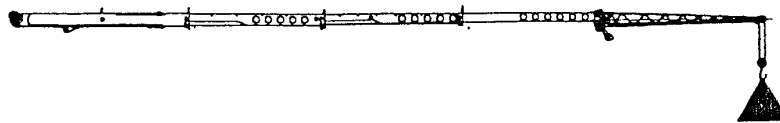
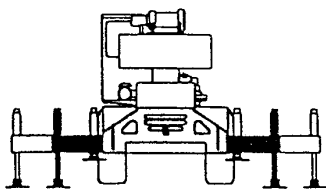

RATED LOAD ON OUTRIGGERS WITH 33 FT OFFSETABLE JIB						
LOADED BOOM ANGLE (DEG)	0° OFFSET		15° OFFSET		30° OFFSET	
	LOAD RADIUS (REF) (FT)	360° (LB)	LOAD RADIUS (REF) (FT)	360° (LB)	LOAD RADIUS (REF) (FT)	360° (LB)
75	38'	9000*	46'	7200*	52'	6000*
73	43'	7700*	50'	6600*	57'	5500*
70	50'	7500*	56'	6300*	63'	5400*
67	57'	6300	63'	4700	69'	4200
64	63'	4800	69'	3700	75'	3200
61	70'	3600	76'	2800	81'	2400
58	76'	2700	81'	2100	86'	1800
54	83'	1700	88'	1200	93'	1100

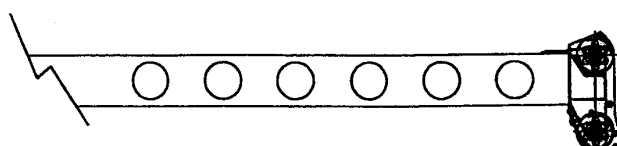

Add 100Lbs to the chart values if the AUX BOOM HEAD SHEAVE is NOT ERECTED.

SET-UP:

1. Crane load ratings are based on the crane being leveled and standing on a firm, uniform supporting surface.
2. Crane load ratings on outriggers are based on all outrigger beams being fully extended, or in the case of partial extension ratings mechanically pinned in the appropriate position, and the tires free of the supporting surface.



**OPERATION:**

1. CRANE LOAD RATINGS MUST NOT BE EXCEEDED. DO NOT ATTEMPT TO TIP THE CRANE TO DETERMINE ALLOWABLE LOADS.
2. When either radius or boom angle, or both, are between listed values, the smaller of the two listed load ratings shall be used.
3. Do not operate at longer radii than those listed on the applicable load rating chart (cross hatched  areas shown on range diagrams) as tipping can occur without a load on the hook.
4. The boom angles shown on the Capacity Chart give an approximation of the operating radius for a fully extended boom. The boom angle, before loading, should be greater to account for boom deflection. It may be necessary to retract the boom if maximum boom angle is insufficient to maintain rated radius.
5. Power telescoping boom sections must be extended equally.
6. For all boom lengths less than the maximum with the jib erected, the rated loads are determined by boom angle only in the appropriate column.
7. For boom angles not shown, use the capacity of the next lower angle.
8. Listed radii are for fully extended boom only.

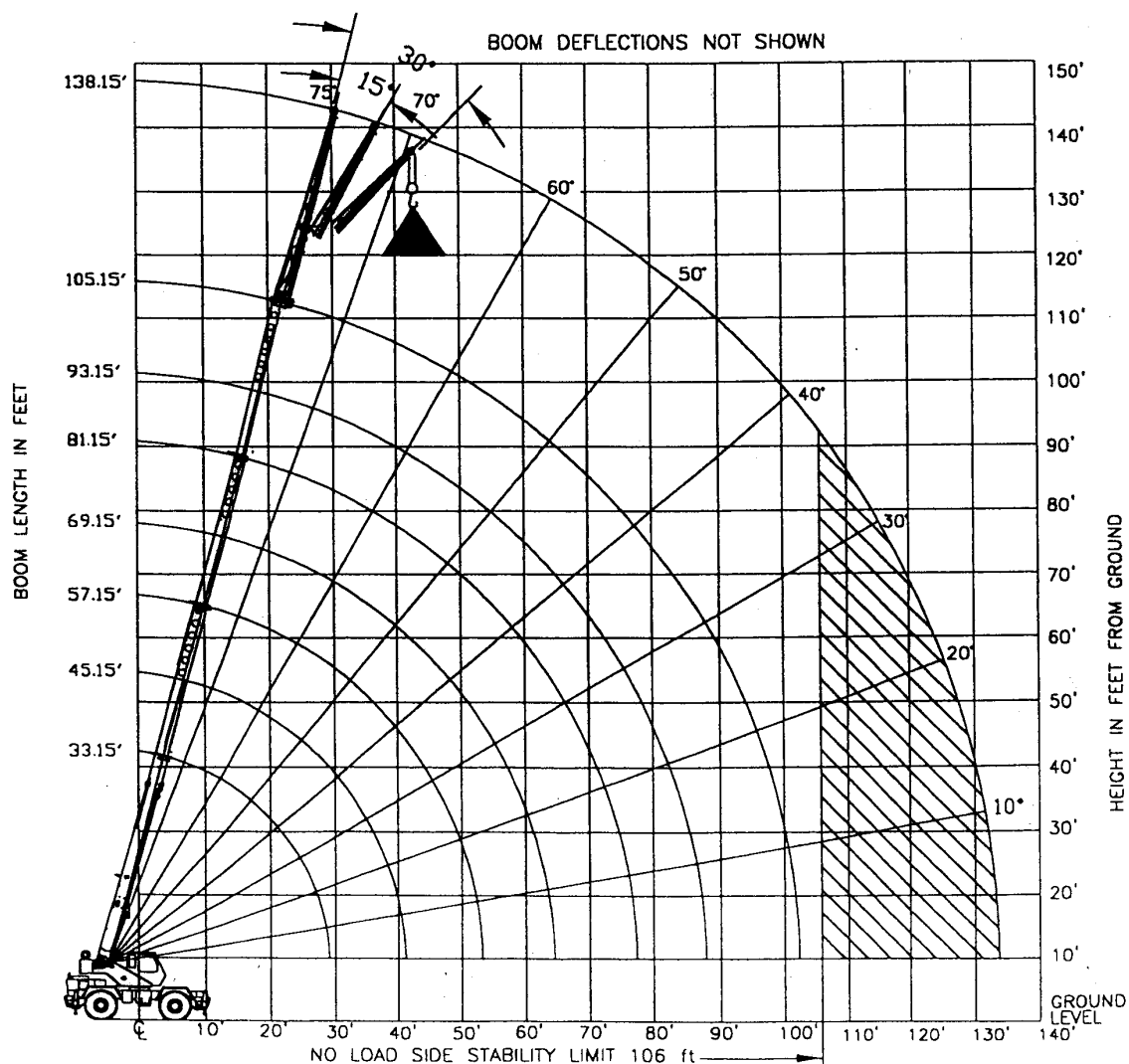

USE THIS CHART WHEN ALL OUTRIGGERS ARE PINNED IN THE MID POSITION  
 USE THIS CHART WHEN THE JIB'S PULL OUT IS RETRACTED

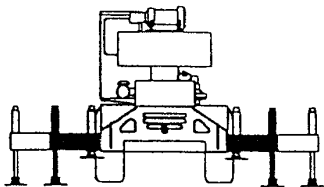

RATED LOAD ON OUTRIGGERS WITH 33 FT OFFSETABLE JIB						
LOADED BOOM ANGLE (DEG)	0° OFFSET		15° OFFSET		30° OFFSET	
	LOAD RADIUS (REF) (FT)	360° (LB)	LOAD RADIUS (REF) (FT)	360° (LB)	LOAD RADIUS (REF) (FT)	360° (LB)
75	38'	9000*	46'	7200*	52'	6000*
73	43'	7700*	50'	6600*	57'	5500*
70	50'	7300*	56'	5900*	63'	5000*
67	57'	5600	63'	4300	69'	3900
64	63'	4200	69'	3200	75'	2800
61	70'	3000	76'	2300	81'	2000
58	76'	2100	81'	1600	86'	1300
54	83'	1100				

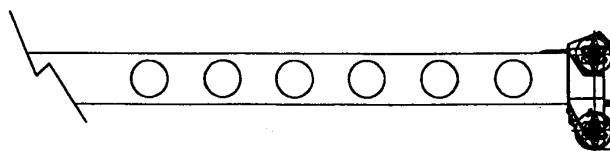

Add 100Lbs to the chart values if the AUX BOOM HEAD SHEAVE is NOT ERECTED.

SET-UP:

1. Crane load ratings are based on the crane being leveled and standing on a firm, uniform supporting surface.
2. Crane load ratings on outriggers are based on all outrigger beams being fully extended, or in the case of partial extension ratings mechanically pinned in the appropriate position, and the tires free of the supporting surface.

**SET-UP:**

1. Crane load ratings are based on the crane being leveled and standing on a firm, uniform supporting surface.
2. Crane load ratings on outriggers are based on all outrigger beams being fully extended, or in the case of partial extension ratings mechanically pinned in the appropriate position, and the tires free of the supporting surface.

**OPERATION:**

1. CRANE LOAD RATINGS MUST NOT BE EXCEEDED. DO NOT ATTEMPT TO TIP THE CRANE TO DETERMINE ALLOWABLE LOADS.
2. When either radius or boom length, or both, are between listed values, the smaller of the two listed load ratings shall be used.
3. Do not operate at longer radii than those listed on the applicable load rating chart (cross hatched areas shown on range diagrams) as tipping can occur without a load on the hook.
4. The boom angles shown on the Capacity Chart give an approximation of the operating radius for a specified boom length. The boom angle, before load, i.g, should be greater to account for boom deflection. It may be necessary to retract the boom if maximum boom angle is insufficient to maintain rated radius.
5. Power telescoping boom sections must be extended equally.

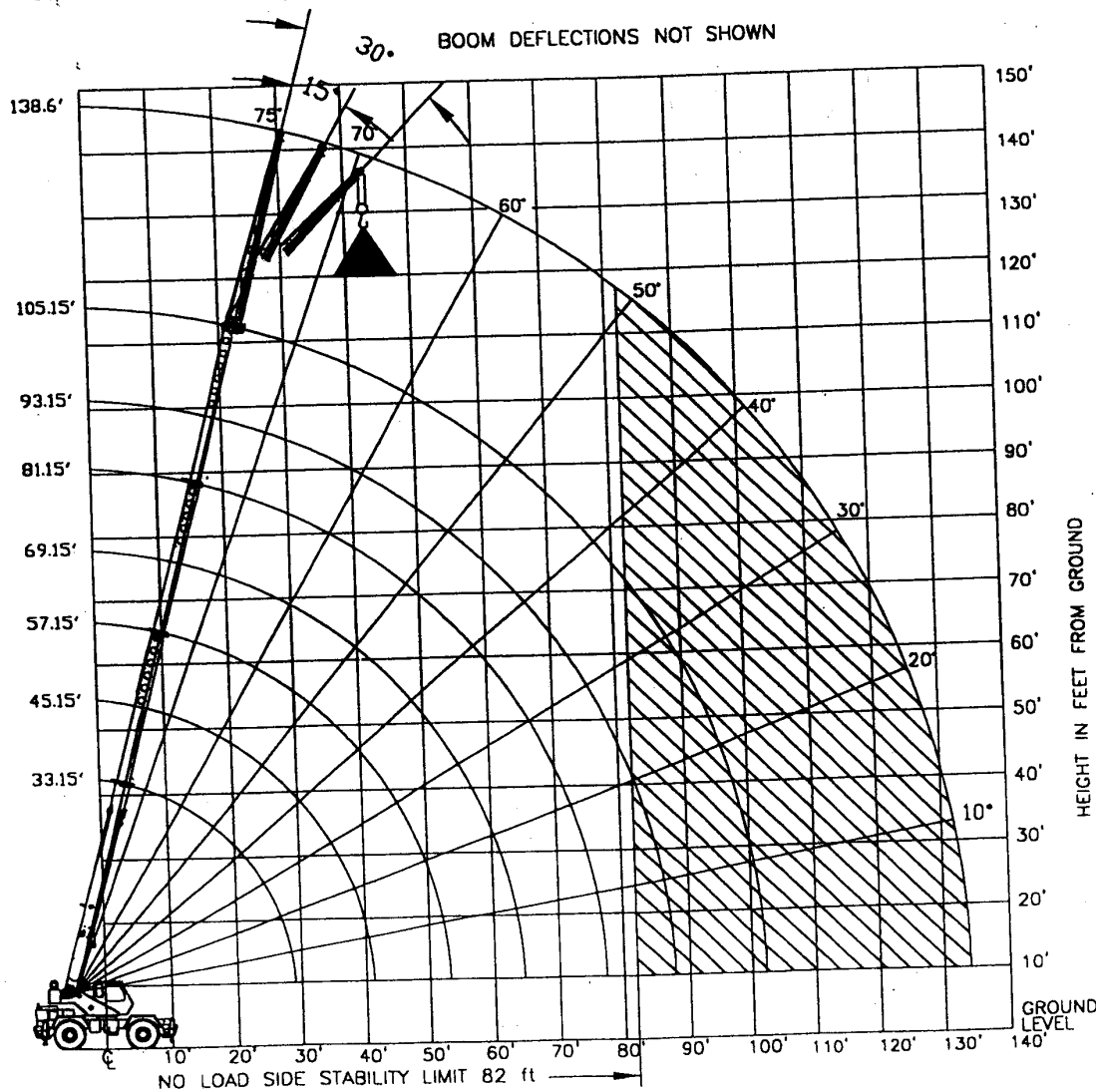

USE THIS CHART WHEN ALL OUTRIGGERS ARE PINNED IN THE MID POSITION

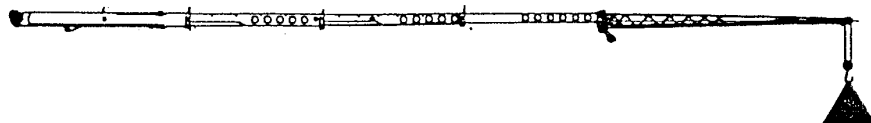
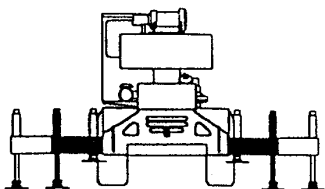

RATED LOAD ON OUTRIGGERS WITH 58 FT OFFSETABLE JIB						
LOADED BOOM ANGLE (DEG)	0° OFFSET		15° OFFSET		30° OFFSET	
	LOAD RADIUS (REF) (FT)	360° (LB)	LOAD RADIUS (REF) (FT)	360° (LB)	LOAD RADIUS (REF) (FT)	360° (LB)
75	50'	5000*	64'	4000*	75'	3300*
73	55'	4700*	69'	3800*	79'	3200*
70	63'	4500*	76'	3500*	86'	2900*
67	71'	4000	83'	2600	92'	2700*
64	78'	2700	90'	2000	98'	1800
61	86'	1900	97'	1500	104'	1300
58	93'	1300				

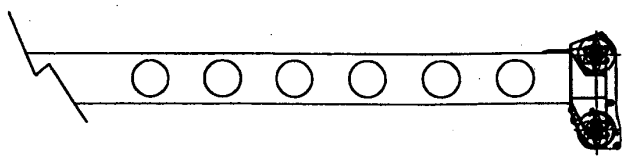

Add 100Lbs to the chart values if the AUX BOOM HEAD SHEAVE is NOT ERECTED.

SET-UP:

1. Crane load ratings are based on the crane being leveled and standing on a firm, uniform supporting surface.
2. Crane load ratings on outriggers are based on all outrigger beams being fully extended, or in the case of partial extension ratings mechanically pinned in the appropriate position, and the tires free of the supporting surface.



**OPERATION:**

1. CRANE LOAD RATINGS MUST NOT BE EXCEEDED. DO NOT ATTEMPT TO TIP THE CRANE TO DETERMINE ALLOWABLE LOADS.
2. When either radius or boom angle, or both, are between listed values, the smaller of the two listed load ratings shall be used.
3. Do not operate at longer radii than those listed on the applicable load rating chart (cross hatched  areas shown on range diagrams) as tipping can occur without a load on the hook.
4. The boom angles shown on the Capacity Chart give an approximation of the operating radius for a fully extended boom. The boom angle, before loading, should be greater to account for boom deflection. It may be necessary to retract the boom if maximum boom angle is insufficient to maintain rated radius.
5. Power telescoping boom sections must be extended equally.
6. For all boom lengths less than the maximum with the jib erected, the rated loads are determined by boom angle only in the appropriate column.
7. For boom angles not shown, use the capacity of the next lower angle.
8. Listed radii are for fully extended boom only.

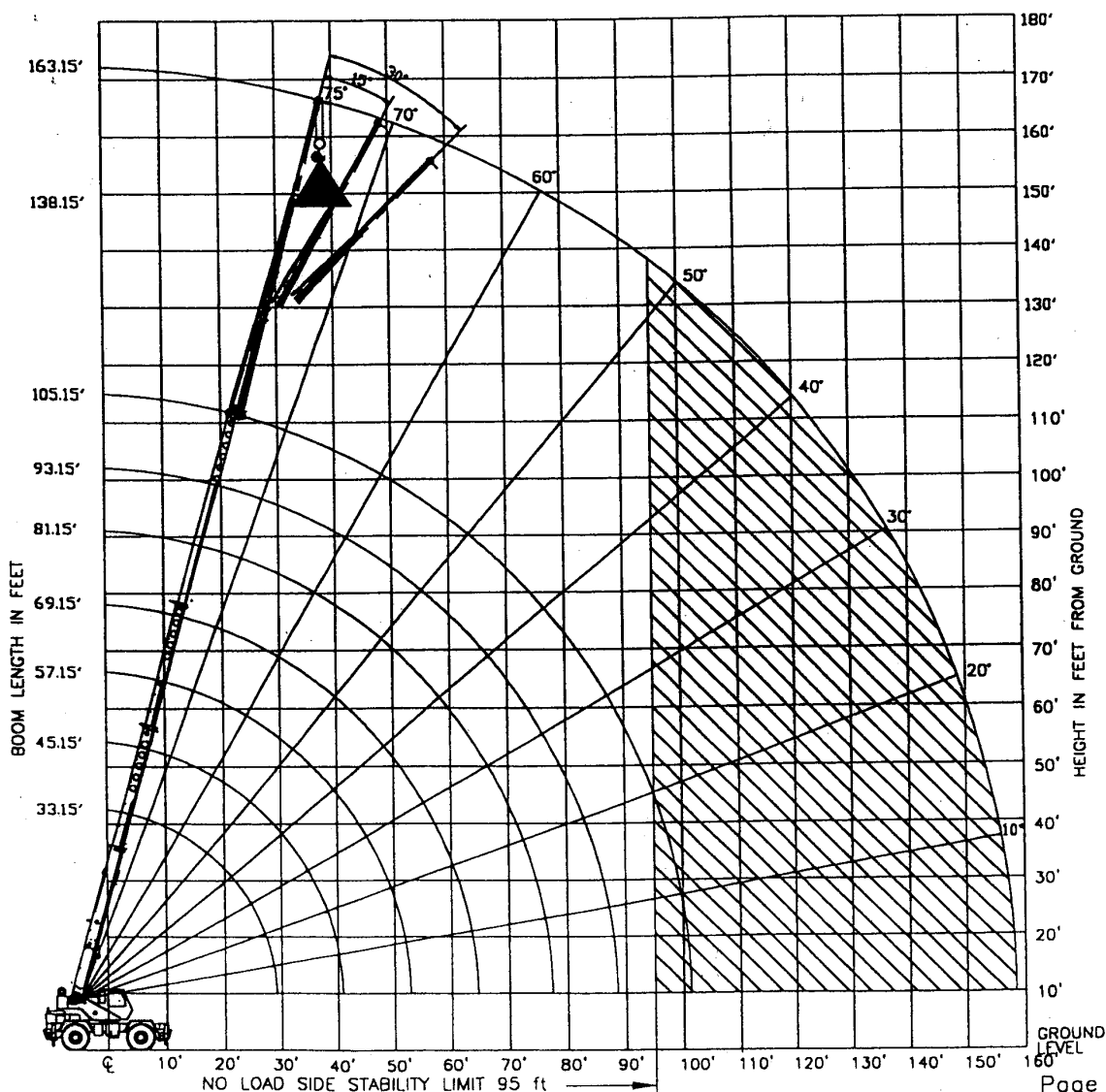

THIS CHART WHEN ALL OUTRIGGER BEAMS ARE NOT IN EITHER THE MID OR FULLY EXTENDED POSITIONS

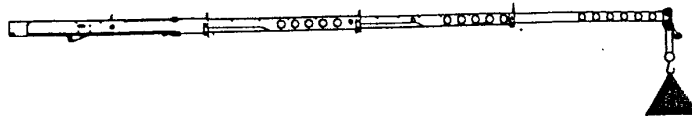
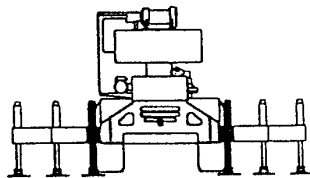

RATED LOAD ON OUTRIGGERS								
LOAD RADIUS (FT)	LOADED BOOM ANGLE (DEG)	360° (LB)	LOAD RADIUS (FT)	LOADED BOOM ANGLE (DEG)	360° (LB)	LOAD RADIUS (FT)	LOADED BOOM ANGLE (DEG)	360° (LB)
BOOM LENGTH 33.15 FT			BOOM LENGTH 45.15 FT			BOOM LENGTH 57.15 FT		
10.0	65.3	69900	10.0	72.2	70600			
12.0	61.5	48800	12.0	69.5	49400	12.0	73.9	49700
15.0	55.4	32200	15.0	65.4	32900	15.0	70.8	33200
20.0	44.0	18600	20.0	58.1	19600	20.0	65.4	19900
25.0	29.6	11600	25.0	50.3	12600	25.0	59.7	13000
29.3	0.0	7400	30.0	41.5	8300	30.0	53.7	8800
			35.0	30.7	5400	35.0	47.2	5900
			40.0	13.9	3200	40.0	39.9	3800
			41.3	0.0	2600	45.0	31.3	2200
BOOM LENGTH 69.15 FT			BOOM LENGTH 81.15 FT			50.0	19.6	1000
15.0	74.2	33300				BOOM LENGTH 93.15 FT		
20.0	69.8	20000	20.0	72.9	20100			
25.0	65.4	13200	25.0	69.2	13300	25.0	72.0	13400
30.0	60.7	9100	30.0	65.4	9200	30.0	68.7	9200
35.0	55.8	6200	35.0	61.4	6400	35.0	65.4	6500
40.0	50.7	4200	40.0	57.3	4400	40.0	61.9	4500
45.0	45.1	2600	45.0	53.0	2800	45.0	58.4	2900
50.0	38.9	1400	50.0	48.4	1600	50.0	54.7	1700
BOOM LENGTH 105.15 FT								
30.0	71.2	9300						
35.0	68.3	6500						
40.0	65.4	4500						
45.0	62.3	3000						
50.0	59.2	1800						

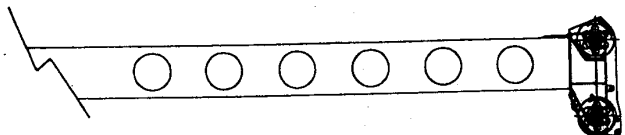

Add 100Lbs to the chart values if the AUX BOOM HEAD SHEAVE is NOT ERECTED.



**SET-UP:**

1. Crane load ratings are based on the crane being leveled and standing on a firm, uniform supporting surface.
2. Crane load ratings on outriggers are based on all outrigger beams being fully extended, or in the case of partial extension ratings mechanically pinned in the appropriate position, and the tires free of the supporting surface.

**OPERATION:**

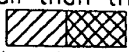
1. CRANE LOAD RATINGS MUST NOT BE EXCEEDED. DO NOT ATTEMPT TO TIP THE CRANE TO DETERMINE ALLOWABLE LOADS.
2. When either radius or boom length, or both, are between listed values, the smaller of the two listed load ratings shall be used.
3. Do not operate at longer radii than those listed on the applicable load rating chart (cross hatched  areas shown on range diagrams) as tipping can occur without a load on the hook.
4. The boom angles shown on the Capacity Chart give an approximation of the operating radius for a specified boom length. The boom angle, before loading, should be greater to account for boom deflection. It may be necessary to retract the boom if maximum boom angle is insufficient to maintain rated radius.
5. Power telescoping boom sections must be extended equally.

**BOOM DEFLECTIONS NOT SHOWN**

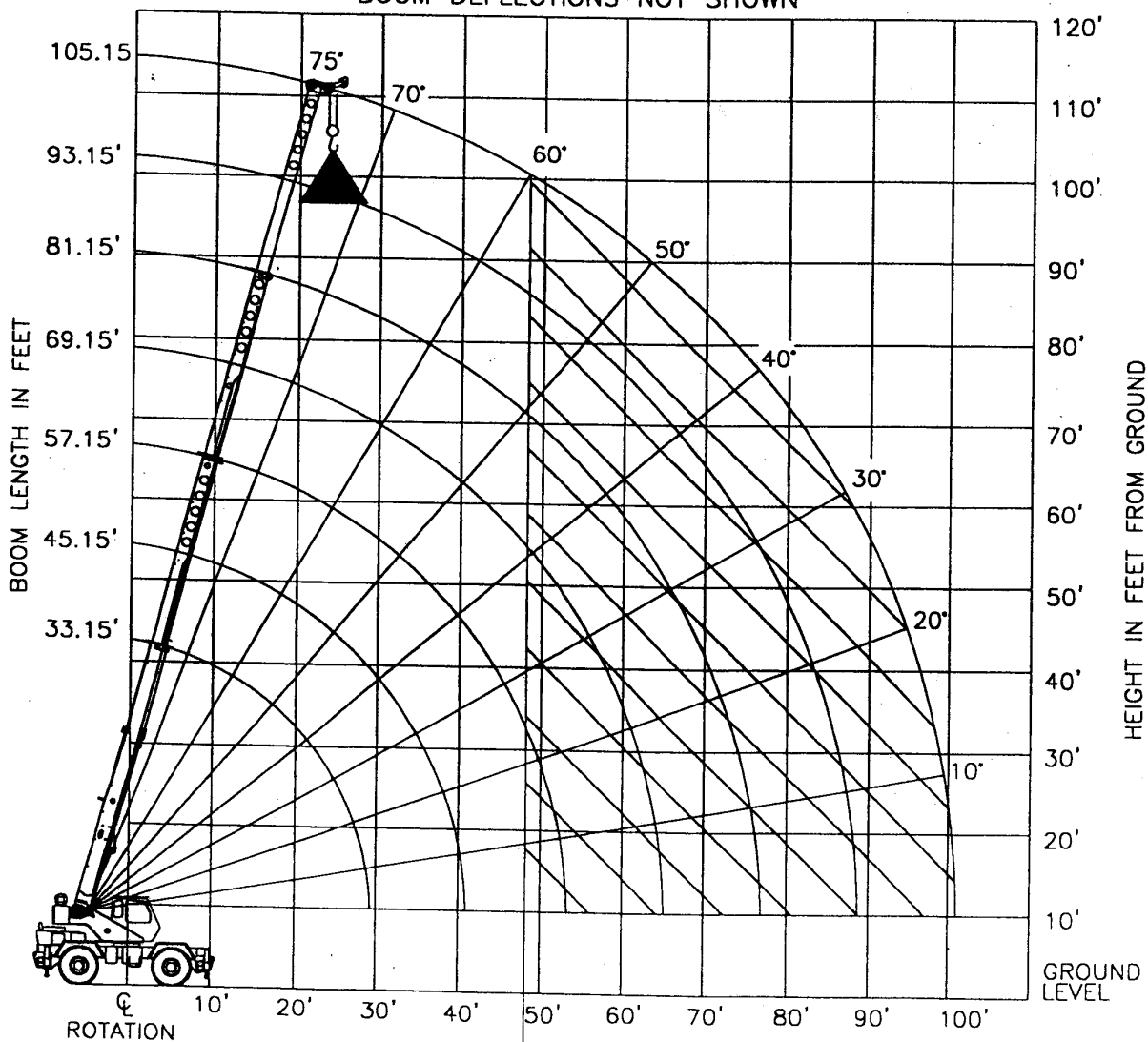

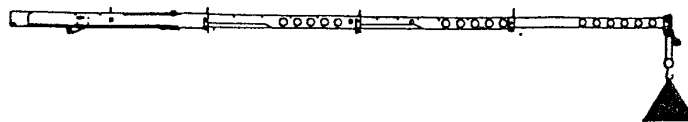

ON TIRES					
RADIUS (FT)	MAX BOOM LENGTH (FT)	21.00X25 28PR			
		STATIONARY		PICK & CARRY	
		360°	STRAIGHT OVER FRONT	CREEP	2.5 MPH
10	33	35,900	69,900*	53,000*	47,100*
12	33	30,500	64,800*	49,300*	43,600*
15	33	22,800	53,400	41,700*	35,800*
20	45	13,900	31,700	31,700	26,900*
25	45	9,200	21,600	21,900	20,900
30	45	6,000	15,200	15,200	15,200
35	45	3,900	11,900	11,900	11,900
40	57	2,300	9,300	9,300	9,300
45	57		7,300	7,300	7,300
50	57		5,900	5,900	5,900
55	69		4,600	4,600	4,600
60	69		3,500	3,500	3,500

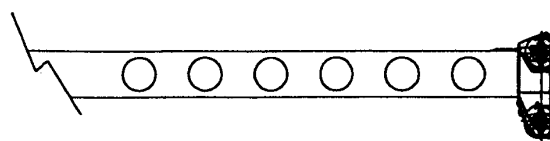
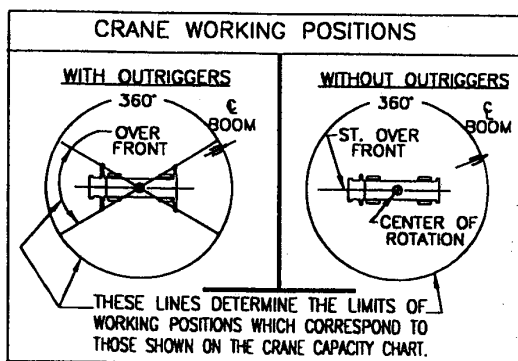

Add 100lbs to the chart values if the AUX BOOM HEAD SHEAVE is NOT ERECTED.

**SET-UP:**

1. Crane load ratings are based on the crane being leveled and standing on a firm, uniform supporting surface.
2. Crane load ratings on tires depend on appropriate inflation pressure and tire conditions. Caution must be exercised when increasing air pressures in tires. Consult Operator's Manual for precautions.
3. Use of jibs, lattice-type boom extensions, or fourth section pullout extended is not permitted for pick and carry operations.

4. For pick and carry operations, boom must be centered over the front of the crane with swing and brake lock engaged. Use minimum boom point height and keep load close to ground surface. Travel must be on smooth level surface.
5. The load should be restrained from swinging. No on tire operation with jib erected.

**OPERATION:**

1. CRANE LOAD RATINGS MUST NOT BE EXCEEDED. DO NOT ATTEMPT TO TIP THE CRANE TO DETERMINE ALLOWABLE LOADS.
2. When radius is between listed values, the smaller of the two listed load ratings shall be used.
3. Do not operate at longer radii than those listed on the applicable load rating chart (cross hatched  areas shown on range diagrams) as tipping can occur without a load on the hook.
4. Power telescoping boom sections must be extended equally.
5. Without outriggers, never maneuver the boom beyond listed load radii for applicable tires used to ensure stability.
6. Creep speed is crane movement of less than 200 ft. (61m) in 30 minute period and not exceeding 1.0 mph (1.6km/h).

**BOOM DEFLECTIONS NOT SHOWN**

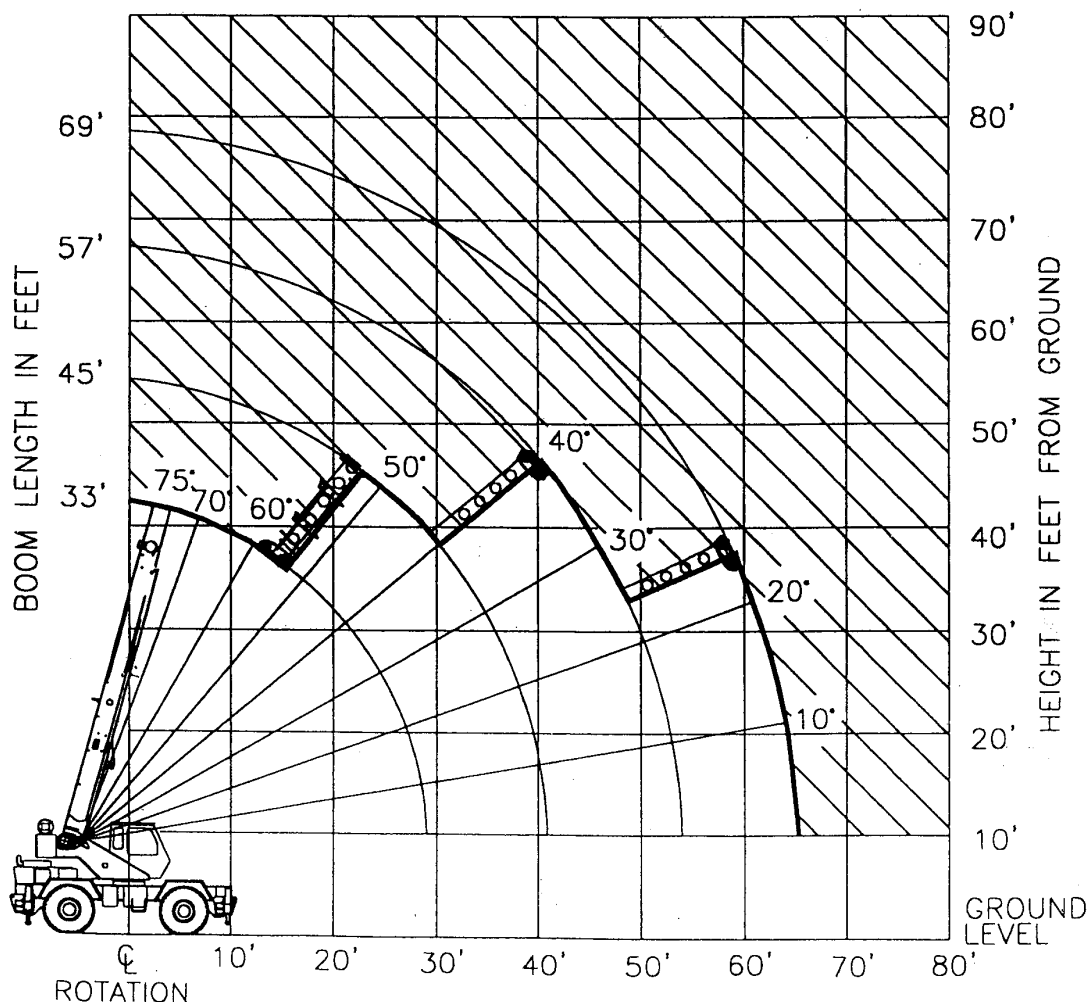

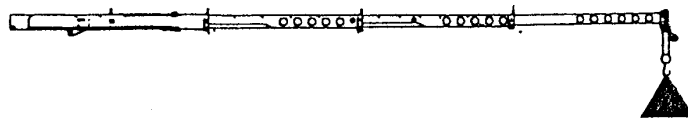

ON TIRES					
RADIUS (FT)	MAX BOOM LENGTH (FT)	26.5 X 25-26 PR			
		STATIONARY		PICK & CARRY	
				CREEP	2.5 MPH
		360°	STRAIGHT OVER FRONT		
10	33	39,400*	61,700*	47,100*	39,700*
12	33	32,000*	56,900*	43,200*	36,200*
15	33	22,900	48,700*	36,500*	30,100*
20	45	14,600	33,100	27,400*	22,400*
25	45	10,400	21,400	21,100	17,000*
30	45	7,400	15,300	15,300	12,900*
35	45	5,100	11,800	11,800	10,200*
40	57	3,400	9,400	9,400	8,100*
45	57	1,900	7,500	7,500	6,400*
50	57		5,900	5,900	5,000*
55	69		4,600	4,600	3,900*
60	69		3,500	3,500	2,900*

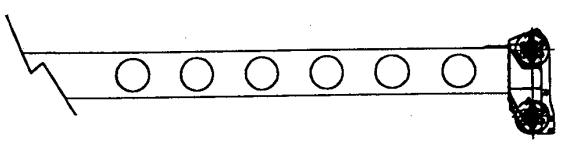
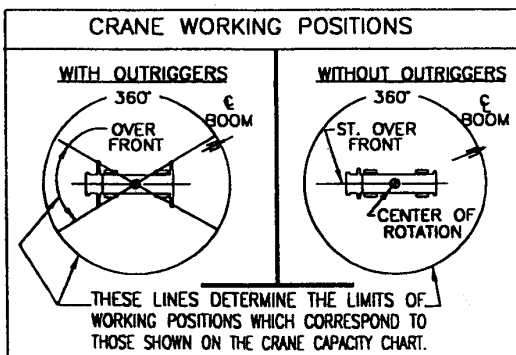

Add 100lbs to the chart values if the AUX BOOM HEAD SHEAVE is NOT ERECTED.

SET-UP:

1. Crane load ratings are based on the crane being leveled and standing on a firm, uniform supporting surface.
2. Crane load ratings on tires depend on appropriate inflation pressure and tire conditions. Caution must be exercised when increasing air pressures in tires. Consult Operator's Manual for precautions.
3. Use of jibs, lattice-type boom extensions, or fourth section pullout extended is not permitted for pick and carry operations.



4. For pick and carry operations, boom must be centered over the front of the crane with swing and brake lock engaged. Use minimum boom point height and keep load close to ground surface. Travel must be on smooth level surface.
5. The load should be restrained from swinging. No on tire operation with jib erected.

**OPERATION:**

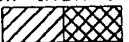
1. CRANE LOAD RATINGS MUST NOT BE EXCEEDED. DO NOT ATTEMPT TO TIP THE CRANE TO DETERMINE ALLOWABLE LOADS.
2. When radius is between listed values, the smaller of the two listed load ratings shall be used.
3. Do not operate at longer radii than those listed on the applicable load rating chart (cross hatched  areas shown on range diagrams) as tipping can occur without a load on the hook.
4. Power telescoping boom sections must be extended equally.
5. Without outriggers, never maneuver the boom beyond listed load radii for applicable tires used to ensure stability.
6. Creep speed is crane movement of less than 200 ft. (61m) in 30 minute period and not exceeding 1.0 mph (1.6km/h).

**BOOM DEFLECTIONS NOT SHOWN**

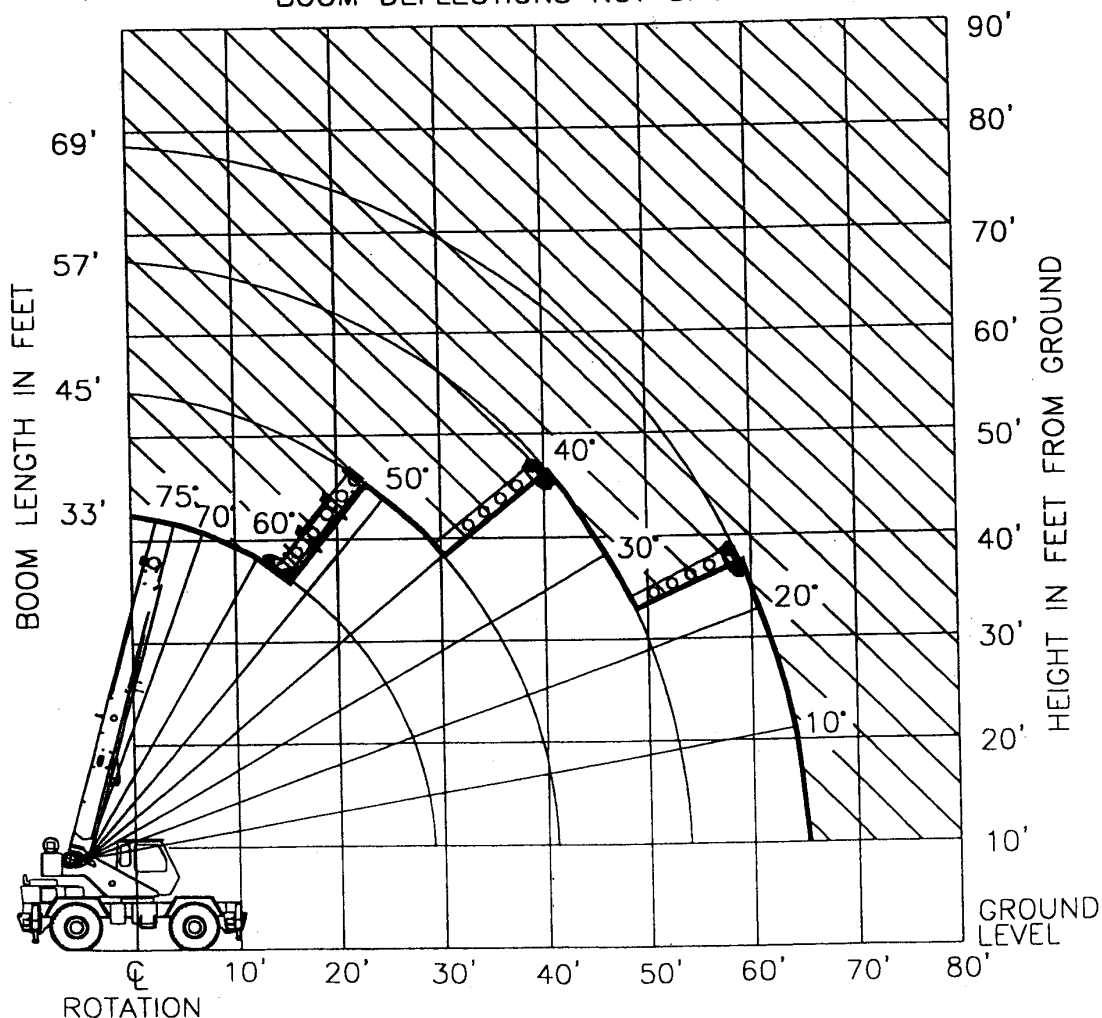

# Built in Waverly, Iowa U.S.A.

**Bigge Crane and Rigging Co.**

10700 Bigge Avenue  
San Leandro, CA 94577  
Phone: (888) 337-BIGGE or (510) 638-8100  
Fax: (510) 639-4053  
Email: info@bigge.com  
Web site: www.bigge.com



**TEREX CRANES**  
Waverly, Iowa 50677

