



TEREX **RT 200/RT 200XL SERIES** Rough Terrain Cranes



FEATURES

- 20-30 tons (18-27 mt) maximum lifting capacity
- 94 ft. (28.6 m) or 100 ft. (30.5 m) maximum boom length
- 141 ft. (43.0 m) or 147 ft. (44.8 m) maximum tip height
- Four-section full power, mechanically synchronized boom with single lever control
- Swingaway jib offsettable 0°, 15° or 30°
- Two-speed main and auxiliary winches
- Quick-reeving boom head and hook block
- Fully independent multi-position out and down outriggers
- Environmental operator's cab optimizes load visibility and productivity
- RCI 510 load system Rated Capacity Indicator
- Easy access for routine servicing of the engine, transmission, batteries, etc. provided by hinged lockable access doors.
- Easy to read load chart books include range diagrams
- 12-month or 2000 hours warranty, major weldments are 5-years or 10,000 hours

simple, available and cost effective™

Machines shown may have optional equipment.



TEREX RT 200/RT 200XL SERIES

Rough Terrain Cranes

- RT 220/RT 200XL – 20 tons (18 mt)
- RT 250/RT 250XL – 25 tons (23 mt)
- RT 275/RT 275XL – 27.5 tons (25 mt)
- RT 230/RT 230XL – 30 tons (27 mt)

94 ft. (28.6 m) or 100 ft. (30.5 m) FOUR-SECTION, FULL-POWER, MECHANICALLY SYNCHRONIZED BOOM WITH SINGLE LEVER CONTROL

- High strength, four plate construction welded inside and out with embossed side plate holes to reduce weight and increase strength.
- Single boom hoist cylinder provides boom elevation of -4° to 76° for easier reeving changes and close radius operation.
- Quick-reeving boom head; no need to remove wedge from socket.
- 360° house lock standard.

ENVIRONMENTAL OPERATOR'S CAB

- Rated Capacity Indicator (RCI) system including anti-two block system with automatic function disconnects.
- Deluxe six-way adjustable operator's seat has torsion bar suspension and adjustable head and arm rests.
- Sound and weather insulated for comfort.
- Removable front window, hinged tinted glass skylight, and sliding right-hand window.
- Dash-mounted controls for swing, boom telescope, boom hoist, and single lever two-speed main winch; pedals for swing brake and boom hoist. Foot accelerator with hand throttle.
- Complete instrumentation. Environmentally-sealed rocker switches. Circuit breakers in cab.

RUGGED, EASY-TO-MANEUVER CARRIER

- Box-type chassis construction with reinforcing cross members.
- Range-shift type power-shift transmission with integral torque converter; neutral start; 6 speeds forward 6 reverse.
- Hydraulic four-wheel power steering for 2-wheel, 4-wheel or crab steer.
- Full air over hydraulic drum type brakes with air dryer.
- Fully independent hydraulic outriggers may be utilized fully extended to 19 ft. (5.79 m), in their 1/2 extended position, or fully retracted.
- Tail swing only 9 ft. (2.74 m).
- Standard Cummins 6BT5.9 diesel engine.
- Easy access for routine servicing of the engine, transmission, batteries, etc. is provided by hinged lockable access doors without the need to unbolt access panels.
- Engine compartment access doors (4), and operators cab are all keyed alike.
- All outside compartments and fluid reservoir access doors/caps have lockable latches or are equipped with padlock hasps.
- Standard 20.5 x 25, 24 P.R. tires.
- Tachometer and rear axle centering light standard.



POWERFUL, TWO-SPEED WINCHES

- 474 fpm (144 m/min) maximum line speed, 12,510 lbs. (5673 kg) maximum line pull. Single lever control.
- Integral automatic brake.
- Electronic drum indicators.
- Grooved drum, tapered flanges, and spring loaded cable roller for improved spooling.

HIGH CAPACITY, DEPENDABLE HYDRAULIC SYSTEM

- Three gear pumps driven off the transmission. Combined system capability is 113 gpm (428 lpm).
- Hydraulic reservoir with 94 gal. (355 l) capacity and full flow oil filtration system.

OPTIONS INCLUDE:

- 72 ft. (21.9 m) main boom.
- 26 ft. or 26 to 43 ft. (7.92 or 7.92 to 13.11 m) swing-on jib. Both offset 0°, 15° or 30°.
- Auxiliary winch with rope.
- Heater/defroster, air conditioner.
- Cold weather starting aid.
- 16.00 x 25, 28 P.R. tires.
- CAT 3116 DIT diesel engine.

For more information, product demonstration, or details on purchase, lease and rental plans, please contact your local Terex Cranes Distributor.

We reserve the right to amend these specifications at any time without notice. The only warranty applicable is our standard written warranty applicable to the particular product and sale. We make no other warranty, expressed or implied.

 **TEREX CRANES**

106 12th Street S.E.
Waverly, IA 50677-9466 USA
(319) 352-3920 • FAX: (319) 352-5727
E-mail: waverly@terexlifting.com

www.terexlift.com



TEREX RT 200/RT200XL SERIES

rough terrain cranes
specifications

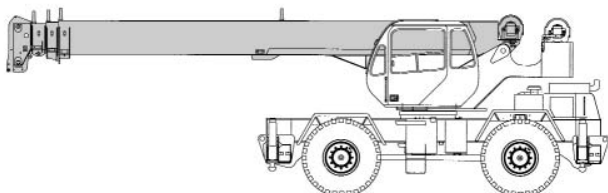

STANDARD BOOM EQUIPMENT

BOOM

30-94 ft. (9.23-28.78 m), four section full power boom. Telescoping is mechanically synchronized with single lever control. The synchronization system consists of a single telescope cylinder and high strength leaf chains to extend and retract the third section and tip section. Boom is high strength four plate design, welded inside and out, with anti-friction slide pads. Boom side plates are made with stamped impressions to reduce weight and increase strength. A single boom hoist cylinder provides for boom elevation of -4 to 76 degrees. All

cylinders are equipped with integral hold valves. Maximum tip height is 99 ft. (30.17 m).

BOOM HEAD

Welded to outer section of boom. Four or five metallic load sheaves and two idler sheaves mounted on heavy duty, anti-friction bearings. Quick reeving boom head. Provisions made for side-stow jib mounting.

OPTIONAL BOOM EQUIPMENT

MAIN BOOM

30-72 ft. (9.23-22.19 m), three section full power boom
OR 30-100 ft (9.23-30.61 m), four section full power XL Series boom.

Telescoping is mechanically synchronized with single lever control. The synchronization system consists of a single telescope cylinder and high strength leaf chains to extend and retract the tip section. Either boom is high strength four plate design, welded inside and out, with anti-friction slide pads. Boom side plates are made with stamped impressions to reduce weight and increase strength. A single boom hoist cylinder provides for boom elevation of -4 to 76 degrees. All cylinders are equipped with integral hold valves. Maximum tip height with 72 ft. (22.19 m) boom option is 79 ft. (24.23 m). Maximum tip height with 100 ft. (30.61 m) XL Series boom option is 107 ft. (32.76 m).

JIBS

26 ft. (7.92m) side stow swing-on one-piece lattice type jib. Single metallic sheave mounted on anti-friction bearing. Jib is offsettable at 0°, 15°, or 30°. With 100 ft. (30.61 m) XL Series boom, maximum tip height is 130 ft. (39.62 m).

26-43 ft. (7.92-13.11 m) side-stow swing-on lattice type jib. Single sheave mounted on anti-friction bearing. Jib is extendible to 43 ft. (13.11 m) by means of a 17 ft. (5.18 m) manual pull-out tip section, roller supported for ease of extension. Jib is offsettable at 0°, 15°, or 30°. With 100 ft. (30.61 m) XL Series boom, maximum tip height is 147 ft. (44.80 m).

AUXILIARY BOOM HEAD

Removable auxiliary boom head has single metallic sheave mounted on anti-friction bearing. Removable pin-type rope guard for quick reeving. Installs on main boom peak only. Removal is not required for jib use.

HOOK BLOCK

Two, three, or four metallic sheaves on anti-friction bearings with hook and hook latch. Quick reeving design does not require removal of wedge and socket from rope.

HOOK & BALL

7.0 ton (6.3 mt) top swivel ball with hook and hook latch.



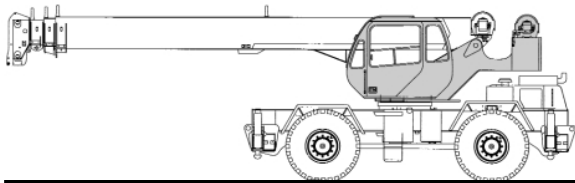

STANDARD UPPERSTRUCTURE EQUIPMENT

UPPERSTRUCTURE FRAME

All welded one-piece structure fabricated with high tensile strength alloy steel. Counterweight is bolted to frame.

TURNTABLE CONNECTION

Swing bearing is a single row, ball type, with external teeth. The swing bearing is bolted to the revolving upperstructure and welded to the carrier frame.

SWING

A hydraulic motor drives a double planetary reduction gear for precise and smooth swing function. Maximum swing speed (no load) is 3.0 rpm.

SWING BRAKE

Heavy duty multiple disc swing brake is mechanically actuated from operator's cab by foot pedal. Brake may be locked on or used as a momentary brake. A separate 360° mechanical house lock is also provided.

RATED CAPACITY INDICATOR

Rated Capacity Indicator with visual and audible warning system and automatic function disconnects. Second generation pictographic display includes: boom radius, boom angle, boom length, allowable load, actual load, and percentage of allowable load registered by bar graph. Operator settable alarms provided for swing angle, boom length, boom angle, tip height, and work area exclusion zone. Anti-two block system includes audio/visual warning and automatic function disconnects.

OPERATOR'S CAB

Environmental cab with all steel construction, optimized visibility, tinted safety glass throughout, and rubber floor matting is mounted on vibration absorbing pads. The cab has a sliding door on the left side, framed sliding window on the right side, hinged tinted all glass skylight and removable front windshield to provide optimized visibility of the load open or closed. Acoustical foam padding insulates against sound and weather.

The deluxe six-way adjustable operator's seat is equipped with a mechanical suspension and includes head and arm rests.

CONTROLS

All control levers and pedals are positioned for efficient operation. Hand operated control levers include swing, telescope, boom hoist, winch(s), shift, vernier adjustable hand throttle and 360° house lock. Switches include ignition, engine stop, two speed winch(s), lights, horn, windshield wipers, defroster, steering mode, parking brake, and outrigger controls. Foot control pedals include swing brake, boom raise, boom lower, service brakes and accelerator.

INSTRUMENTATION AND ACCESSORIES

In-cab gauges include air pressure, bubble level, engine oil pressure, fuel, engine temperature, voltmeter, transmission temperature, and transmission oil pressure. Indicators include low air, high water temperature/low oil pressure/high transmission temperature audio/visual warning, low coolant audio/visual warning, hoist drum rotation indicator(s), and Rated Capacity Indicator. Accessories include fire extinguisher; light package including headlights, tail lights, dome light, brake lights, directional signals, four-way hazard flashers, dome light, and back-up lights with audio pulsating back-up alarm; windshield washer/wiper and skylight wiper, R.H. and L.H. rear view mirrors; dash lights; and seat belt. Circuit breakers protect electrical circuits.

HYDRAULIC CONTROL VALVES

Valves are mounted on the upperstructure and are easily accessible. Valves are mechanically operated and include one four spool valve for boom elevation, telescope, main winch boost, and main winch; one single spool valve for swing. High pressure regeneration feature provides 2-speed boom extension. Quick disconnects are provided for ease of installation of pressure check gauges.

OPTIONAL EQUIPMENT

Auxiliary Winch • Heater/Defroster • Air Conditioner • Work Lights • Revolving Amber Light • Independent Rear Wheel Steering • Roof Mounted Spotlight

STANDARD CARRIER EQUIPMENT

CARRIER CHASSIS

High strength chassis with four-wheel drive and four-wheel steer (4x4x4). Has box beam type construction with reinforcing cross members, a precision machined turntable mounting plate and integrally welded outrigger boxes. Decking has skid-resistant surfaces, including tool storage compartment, and access steps and handles left and right side and front and rear corners.

AXLES AND SUSPENSION

Rear axle is a planetary drive/steer type with total 10 in. (0.25m) of oscillation. Automatic oscillation lockouts engage when the superstructure is swung 10° in either direction. Front axle is planetary drive/steer type, rigid mounted to the frame for increased stability.

WHEELS & TIRES

Disc type wheels with full tapered bead seat rim. 134 in. (3.40 m) wheelbase.

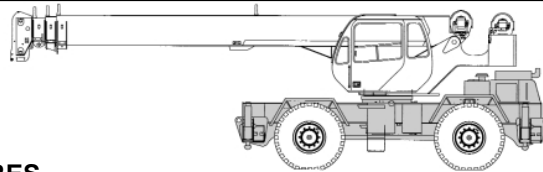

TIRES

Standard: 20.5 x 25,24 P.R.
Optional: 16.00 x 25, 28 P.R.

SERVICE BRAKES

Air over hydraulic drum type brakes on all four wheels: 17" x 4" (43.18 x 10.2 cm) drum brakes.

PARKING BRAKE

Transmission mounted spring-set, air released external caliper disk type emergency/parking brake.

STEERING

Hydraulic four-wheel power steering for two-wheel, four-wheel, or crab steer is easily controlled by steering wheel. A rear axle centering light is provided.



STANDARD CARRIER EQUIPMENT (continued)

Turning radius to center of outside tire.

	(16.00 x 25)	(20.5 x 25)
Two-wheel:	34' 8.81" (10.50m)	34' 10.38" (10.63m)
Four-wheel:	19' 3.44" (5.88m)	19' 5" (5.92m)

TRANSMISSION

Range-shift type power-shift transmission with integral torque converter has neutral safety start, 6 speeds forward, and 6 speeds reverse. Automatic pulsating back-up alarm.

MULTI-POSITION OUT & DOWN OUTRIGGERS

Fully independent hydraulic outriggers may be utilized fully extended, in their 1/2 extended position, or fully retracted. Easily

HYDRAULIC SYSTEM

HYDRAULIC PUMPS

Three gear type pumps, one single and two in tandem, driven off the transmission. Combined system capability is 113 gpm (427.7 lpm). Includes manual pump disconnect.

Main and Auxiliary Winch Pump

53 gpm (200.7 lpm) @ 3,500 psi (246.1 kg/cm²)

Boom Hoist, Telescope Pump

39 gpm (147.6 lpm) @ 3,500 psi (246.1 kg/cm²)

Power Steering, Outrigger and Swing Pump

21 gpm (79.5 lpm) @ 2,500 psi (175 kg/cm²). Always live even when pump disconnect is actuated.

removable steel floats, each with an area of 254 in² (1639 cm²), stow on the carrier frame. Complete controls and sight leveling bubble are located in the operators' cab.

OPTIONAL EQUIPMENT

Cold Weather Starting Aid • Immersion Heater • Pintle Hook • Clearance Lights • Front Mounted Winch – 20,000 lbs. (9072 kg) • Independent Rear or Four Mode Rear Wheel Steer

FILTRATION

Full flow oil filtration system with bypass protection includes a removable 60 mesh (250 micron) suction screen-type filter and 5 micron replaceable return line filter.

HYDRAULIC RESERVOIR

All steel, welded construction with internal baffles and diffuser. Provides easy access to filters and is equipped with an external sight level gauge. The hydraulic tank is pressurized to aid in keeping out contaminants and in reducing potential pump cavitation. Capacity is 94 gal (355 liters). Swing-away hydraulic oil cooler is standard.

MAIN WINCH SPECIFICATIONS

Hydraulic winch with bent axis piston motor and planetary reduction provides 2-speed operation with equal speeds for power up and down. Winch is equipped with an integral automatic brake, a grooved drum with tapered flanges for improved rope spooling, a spring loaded cable roller and an electronic drum rotation indicator.

PERFORMANCE	LO-RANGE	HI-RANGE
Max. line speed (no load)		
First layer	205 fpm (62.5 m/min)	329 fpm (100.3 m/min)
Fifth layer	297 fpm (90.5 m/min)	475 fpm (144.8 m/min)
Max. line pull-first layer	12,512 lbs (5675 kg)	7,298 lbs (3310 kg)
Max. line pull-fifth layer	8,662 lbs (3929 kg)	5,052 lbs (2292 kg)
Permissible line pull	9,000 lbs (4082 kg)	

DRUM DIMENSIONS	DRUM CAPACITY
10.62 in (270 mm) drum diameter	Max. Storage: 598 ft (182.3 m)
17.53 in (445 mm) length	6th layer not a working layer
18.25 in (464 mm) flange dia.	Max. Useable: 479 ft (146.0 m)*
Cable: 5/8 in. x 450 ft (16 mm x 137.2 m)	
Cable type: 5/8 in. (16mm) 6x19 IWRC IPS right regular lay, preformed	* Based on min. flange height above top layer to comply with ANSI B30.5
Min. breaking strength 17.9 tons (16.2 mt).	

OPTIONAL AUXILIARY WINCH

Hydraulic winch with bent axis piston motor, power up and down, equal speed, planetary reduction with integral automatic brake, cable roller, and rotation indicator.

PERFORMANCE
(Same as main winch)

DRUM DIMENSIONS AND CAPACITY
(Same as main winch)

DRUM CAPACITY
(Same as main winch)

OPTIONAL HOIST LINE – MAIN WINCH AND OPTIONAL AUXILIARY WINCH – 5/8 in. (16 mm) rotation resistant compacted strand 18x19 or 19x19. Min. breaking strength 22.6 tons (20.6 mt).

PERFORMANCE (Standard Engine)

Transmission Range	Gear	Forward Drive	Maximum Speed	Maximum Tractive Effort	Gradeability @ Stall
Low	1	4-wheel	2.3 mph	37,856 lbs	112.34%
			3.7 km/h	17 171 kg	
	2	4-wheel	4.4 mph	19,254 lbs	39.84%
			7.1 km/h	8734 kg	
	3	4-wheel	12.4 mph	6,431 lbs	11.10%
			20.0 km/h	2917 kg	
High	1	2-wheel	5.0 mph	16,893 lbs	34.04%
			8.0 km/h	7663 kg	
	2	2-wheel	9.5 mph	8,589 lbs	15.59%
			15.3 km/h	3896 kg	
	3	2-wheel	24.5 mph	2,849 lbs	3.77%
			39.4 km/h	1292 kg	

All performance data is based on a gross vehicle weight of 52,000 lbs (23 583 kg), 16:00 x 25 tires, 4 x 4 drive. Performance may vary due to engine performance. Gradeability data is theoretical and is limited by tire slip, stability, or engine oil pan design.

ENGINE SPECIFICATIONS

Make and Model	Standard Cummins 6BTA5.9	Optional Caterpillar 3116 DIT
Type	6 cylinder	6 cylinder
Bore and Stroke	4.02 x 4.72 in (102 x 120 mm)	4.12 x 5.0 in (105 x 127 mm)
Displacement	359 cu in (5.9 l)	402 cu in (6.6 l)
Max. Gross Horsepower	130 hp (97 kw) @ 2500 rpm	140 hp (105 kw) @ 2400 rpm
Max. Gross Torque	384 lb•ft (521 N•m) @ 1200 rpm	426 lb•ft (578 N•m) @ 1450 rpm
Aspiration	turbocharged	turbocharged
Air Filter	dry type	dry type
Electrical System	12 volt	12 volt
Alternator	102 amp	115 amp
Battery	(2) 12V-1600 C.C.A.	(2) 12V-1600 C.C.A.
Fuel Capacity	50 gal (189 l)	50 gal (189 l)



GENERAL DIMENSIONS

NOTES:

- Dimensions given assume the boom is fully retracted in travel position and 16:00 x 25 tires. 20.5 tires reduce heights 1.0 (25mm).
- Minimum ground clearance under transmission – 20.62" (0.52m)
 axle bowls – 19.12" (0.49m)
 tie rods – 20.38" (0.52m)

- Track width: 6' 7.50" (2.02m) 16:00 x 25 tires
 6' 10.5" (2.10m) 20.5 x 25 tires
- Width of carrier:
 8'0" (2.44m) 16:00 x 25 tires
 8'8" (2.64m) 20.5 x 25 tires

Tire to frame angle	16:00 tires	20.5 tires
Approach angle:	25.1°	24.1°
Departure angle:	23.1°	22.2°

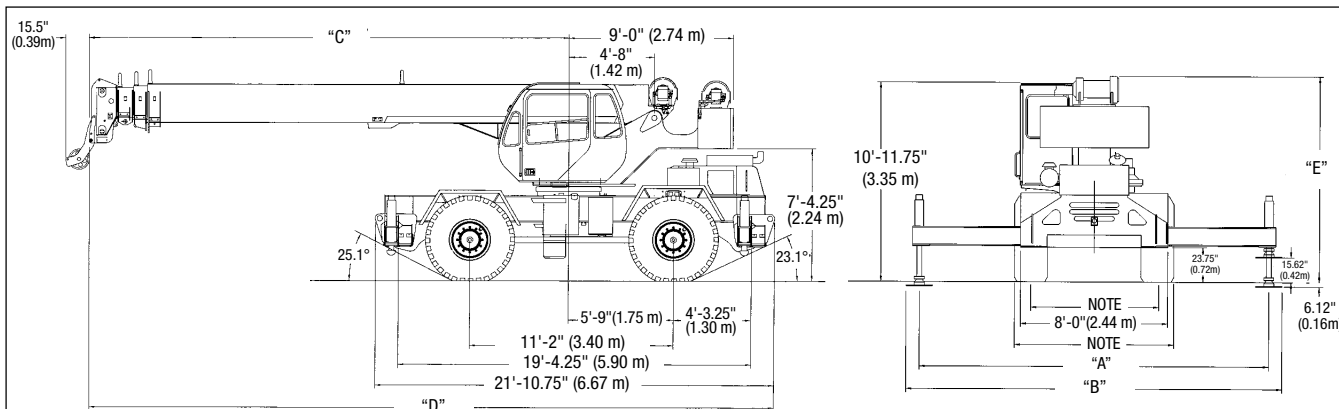

	"A"	"B"	Boom Length	"C"	"D"	"E"
Fully extended outriggers	19'-0" (5.79m)	20'-6" (6.25m)	32' (9.75m) Boom	15'-10" (4.83m)	27'-1" (8.25m)	12'-9.38" (3.90m)
Pinned outriggers	13'-2" (4.01m)	14'-8" (4.47m)	72' (22.19m) Boom	26'-4" (8.03m)	37'-7" (11.46m)	11'-7.5" (3.54m)
Fully retracted outriggers	7'-4.5" (2.25m)	8'-10.5" (2.71 m)	94' (28.78m) Boom	26'-4" (8.03m)	37'-7" (11.46m)	11'-7.5" (3.54m)
			100' (30.61m) Boom	28'-4" (8.64m)	39'-7" (12.06m)	11'-7.5" (3.54m)

WEIGHTS & AXLE LOADS	GROSS WEIGHT LBS.	UPPER FACING FRONT		GROSS WEIGHT KG.	UPPER FACING FRONT	
		FRONT	REAR		FRONT	REAR
Basic Crane with 10,000 lb. (4536 kg) Counterweight	55,930	28,972	26,958	25,369	13 141	12 228
Add Options:						
26' (7.92 m) Swing-on Jib (Stowed)	+ 1,100	+ 2,000	- 900	+ 499	+ 907	- 408
26'-43' (7.92-13.11 m) Swing-on Jib (Stowed)	+ 1,500	+ 2,600	- 1,100	+ 680	+ 1179	- 499
Auxiliary Boom Head	+ 100	+ 300	- 200	+ 45	+ 136	- 91
Auxiliary Winch with Wire Rope, Controls, Etc.	+ 115	- 25	+ 140	+ 52	- 11	+ 63
30 ton (27.2 mt) 4 Sheave Hook Block	+ 655	+ 1,071	- 416	+ 297	+ 486	- 189
30 ton (27.2 mt) 3 Sheave Hook Block	+ 670	+ 1,099	- 429	+ 304	+ 498	- 194
25 ton (22.6 mt) 2 Sheave Hook Block	+ 682	+ 1,117	- 435	+ 309	+ 507	- 198
6.25 ton (5.7 mt) Hook and Ball (in tool box)	+ 240	+ 290	- 50	+ 109	+ 130	- 21
Pintle Hook: Front	+ 45	+ 60	- 15	+ 20	+ 27	- 7
Rear	+ 45	- 25	+ 70	+ 20	- 11	+ 31
Substitute:						
72' (22.19 m) Full Power 3-section Boom	- 3,190	- 4,335	+ 1,145	- 1445	- 1965	+ 520
100' (30.61 m) Full Power 4-Section Boom	+ 533	+ 1986	- 1453	+ 242	+ 901	- 659
16.00 x 25 Tires	- 360	- 180	- 180	- 164	- 82	- 82

NOTE: Weights are for factory supplied equipment and subject to 2% variation due to manufacturing tolerances.

WE RESERVE THE RIGHT TO AMEND THESE SPECIFICATIONS AT ANY TIME WITHOUT NOTICE. THE ONLY WARRANTY APPLICABLE IS OUR STANDARD WRITTEN WARRANTY APPLICABLE TO THE PARTICULAR PRODUCT AND SALE. WE MAKE NO OTHER WARRANTY, EXPRESSED OR IMPLIED.

TEREX CRANES

106 12th Street S.E.
 Waverly, IA 50677-9466 USA
 (319) 352-3920 • FAX: (319) 352-5727
 E-mail: inquire@terexwaverly.com





TEREX RT 200/RT200XL SERIES

rough terrain cranes
specifications

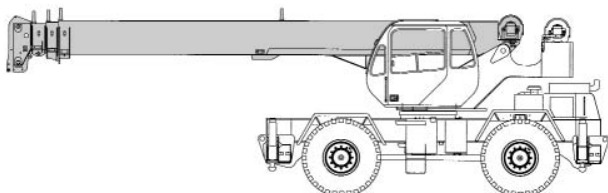

STANDARD BOOM EQUIPMENT

BOOM

30-94 ft. (9.23-28.78 m), four section full power boom. Telescoping is mechanically synchronized with single lever control. The synchronization system consists of a single telescope cylinder and high strength leaf chains to extend and retract the third section and tip section. Boom is high strength four plate design, welded inside and out, with anti-friction slide pads. Boom side plates are made with stamped impressions to reduce weight and increase strength. A single boom hoist cylinder provides for boom elevation of -4 to 76 degrees. All

cylinders are equipped with integral hold valves. Maximum tip height is 99 ft. (30.17 m).

BOOM HEAD

Welded to outer section of boom. Four or five metallic load sheaves and two idler sheaves mounted on heavy duty, anti-friction bearings. Quick reeving boom head. Provisions made for side-stow jib mounting.

OPTIONAL BOOM EQUIPMENT

MAIN BOOM

30-72 ft. (9.23-22.19 m), three section full power boom
OR 30-100 ft (9.23-30.61 m), four section full power XL Series boom.

Telescoping is mechanically synchronized with single lever control. The synchronization system consists of a single telescope cylinder and high strength leaf chains to extend and retract the tip section. Either boom is high strength four plate design, welded inside and out, with anti-friction slide pads. Boom side plates are made with stamped impressions to reduce weight and increase strength. A single boom hoist cylinder provides for boom elevation of -4 to 76 degrees. All cylinders are equipped with integral hold valves. Maximum tip height with 72 ft. (22.19 m) boom option is 79 ft. (24.23 m). Maximum tip height with 100 ft. (30.61 m) XL Series boom option is 107 ft. (32.76 m).

JIBS

26 ft. (7.92m) side stow swing-on one-piece lattice type jib. Single metallic sheave mounted on anti-friction bearing. Jib is offsettable at 0°, 15°, or 30°. With 100 ft. (30.61 m) XL Series boom, maximum tip height is 130 ft. (39.62 m).

26-43 ft. (7.92-13.11 m) side-stow swing-on lattice type jib. Single sheave mounted on anti-friction bearing. Jib is extendible to 43 ft. (13.11 m) by means of a 17 ft. (5.18 m) manual pull-out tip section, roller supported for ease of extension. Jib is offsettable at 0°, 15°, or 30°. With 100 ft. (30.61 m) XL Series boom, maximum tip height is 147 ft. (44.80 m).

AUXILIARY BOOM HEAD

Removable auxiliary boom head has single metallic sheave mounted on anti-friction bearing. Removable pin-type rope guard for quick reeving. Installs on main boom peak only. Removal is not required for jib use.

HOOK BLOCK

Two, three, or four metallic sheaves on anti-friction bearings with hook and hook latch. Quick reeving design does not require removal of wedge and socket from rope.

HOOK & BALL

7.0 ton (6.3 mt) top swivel ball with hook and hook latch.



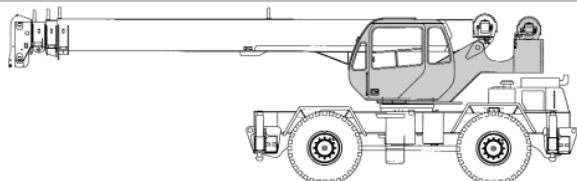

STANDARD UPPERSTRUCTURE EQUIPMENT

UPPERSTRUCTURE FRAME

All welded one-piece structure fabricated with high tensile strength alloy steel. Counterweight is bolted to frame.

TURNTABLE CONNECTION

Swing bearing is a single row, ball type, with external teeth. The swing bearing is bolted to the revolving upperstructure and welded to the carrier frame.

SWING

A hydraulic motor drives a double planetary reduction gear for precise and smooth swing function. Maximum swing speed (no load) is 3.0 rpm.

SWING BRAKE

Heavy duty multiple disc swing brake is mechanically actuated from operator's cab by foot pedal. Brake may be locked on or used as a momentary brake. A separate 360° mechanical house lock is also provided.

RATED CAPACITY INDICATOR

Rated Capacity Indicator with visual and audible warning system and automatic function disconnects. Second generation pictographic display includes: boom radius, boom angle, boom length, allowable load, actual load, and percentage of allowable load registered by bar graph. Operator settable alarms provided for swing angle, boom length, boom angle, tip height, and work area exclusion zone. Anti-two block system includes audio/visual warning and automatic function disconnects.

OPERATOR'S CAB

Environmental cab with all steel construction, optimized visibility, tinted safety glass throughout, and rubber floor matting is mounted on vibration absorbing pads. The cab has a sliding door on the left side, framed sliding window on the right side, hinged tinted all glass skylight and removable front windshield to provide optimized visibility of the load open or closed. Acoustical foam padding insulates against sound and weather.

The deluxe six-way adjustable operator's seat is equipped with a mechanical suspension and includes head and arm rests.

CONTROLS

All control levers and pedals are positioned for efficient operation. Hand operated control levers include swing, telescope, boom hoist, winch(s), shift, vernier adjustable hand throttle and 360° house lock. Switches include ignition, engine stop, two speed winch(s), lights, horn, windshield wipers, defroster, steering mode, parking brake, and outrigger controls. Foot control pedals include swing brake, boom raise, boom lower, service brakes and accelerator.

INSTRUMENTATION AND ACCESSORIES

In-cab gauges include air pressure, bubble level, engine oil pressure, fuel, engine temperature, voltmeter, transmission temperature, and transmission oil pressure. Indicators include low air, high water temperature/low oil pressure/high transmission temperature audio/visual warning, low coolant audio/visual warning, hoist drum rotation indicator(s), and Rated Capacity Indicator. Accessories include fire extinguisher; light package including headlights, tail lights, dome light, brake lights, directional signals, four-way hazard flashers, dome light, and back-up lights with audio pulsating back-up alarm; windshield washer/wiper and skylight wiper, R.H. and L.H. rear view mirrors; dash lights; and seat belt. Circuit breakers protect electrical circuits.

HYDRAULIC CONTROL VALVES

Valves are mounted on the upperstructure and are easily accessible. Valves are mechanically operated and include one four spool valve for boom elevation, telescope, main winch boost, and main winch; one single spool valve for swing. High pressure regeneration feature provides 2-speed boom extension. Quick disconnects are provided for ease of installation of pressure check gauges.

OPTIONAL EQUIPMENT

Auxiliary Winch • Heater/Defroster • Air Conditioner • Work Lights • Revolving Amber Light • Independent Rear Wheel Steering • Roof Mounted Spotlight

STANDARD CARRIER EQUIPMENT

CARRIER CHASSIS

High strength chassis with four-wheel drive and four-wheel steer (4x4x4). Has box beam type construction with reinforcing cross members, a precision machined turntable mounting plate and integrally welded outrigger boxes. Decking has skid-resistant surfaces, including tool storage compartment, and access steps and handles left and right side and front and rear corners.

AXLES AND SUSPENSION

Rear axle is a planetary drive/steer type with total 10 in. (0.25m) of oscillation. Automatic oscillation lockouts engage when the superstructure is swung 10° in either direction. Front axle is planetary drive/steer type, rigid mounted to the frame for increased stability.

WHEELS & TIRES

Disc type wheels with full tapered bead seat rim. 134 in. (3.40 m) wheelbase.

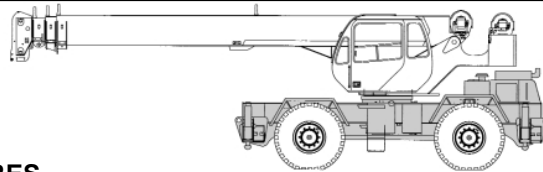

TIRES

Standard: 20.5 x 25,24 P.R.
Optional: 16.00 x 25, 28 P.R.

SERVICE BRAKES

Air over hydraulic drum type brakes on all four wheels: 17" x 4" (43.18 x 10.2 cm) drum brakes.

PARKING BRAKE

Transmission mounted spring-set, air released external caliper disk type emergency/parking brake.

STEERING

Hydraulic four-wheel power steering for two-wheel, four-wheel, or crab steer is easily controlled by steering wheel. A rear axle centering light is provided.



STANDARD CARRIER EQUIPMENT (continued)

Turning radius to center of outside tire.

	(16.00 x 25)	(20.5 x 25)
Two-wheel:	34' 8.81" (10.50m)	34' 10.38" (10.63m)
Four-wheel:	19' 3.44" (5.88m)	19' 5" (5.92m)

TRANSMISSION

Range-shift type power-shift transmission with integral torque converter has neutral safety start, 6 speeds forward, and 6 speeds reverse. Automatic pulsating back-up alarm.

MULTI-POSITION OUT & DOWN OUTRIGGERS

Fully independent hydraulic outriggers may be utilized fully extended, in their 1/2 extended position, or fully retracted. Easily

HYDRAULIC SYSTEM

HYDRAULIC PUMPS

Three gear type pumps, one single and two in tandem, driven off the transmission. Combined system capability is 113 gpm (427.7 lpm). Includes manual pump disconnect.

Main and Auxiliary Winch Pump

53 gpm (200.7 lpm) @ 3,500 psi (246.1 kg/cm²)

Boom Hoist, Telescope Pump

39 gpm (147.6 lpm) @ 3,500 psi (246.1 kg/cm²)

Power Steering, Outrigger and Swing Pump

21 gpm (79.5 lpm) @ 2,500 psi (175 kg/cm²). Always live even when pump disconnect is actuated.

removable steel floats, each with an area of 254 in² (1639 cm²), stow on the carrier frame. Complete controls and sight leveling bubble are located in the operators' cab.

OPTIONAL EQUIPMENT

Cold Weather Starting Aid • Immersion Heater • Pintle Hook • Clearance Lights • Front Mounted Winch – 20,000 lbs. (9072 kg) • Independent Rear or Four Mode Rear Wheel Steer

FILTRATION

Full flow oil filtration system with bypass protection includes a removable 60 mesh (250 micron) suction screen-type filter and 5 micron replaceable return line filter.

HYDRAULIC RESERVOIR

All steel, welded construction with internal baffles and diffuser. Provides easy access to filters and is equipped with an external sight level gauge. The hydraulic tank is pressurized to aid in keeping out contaminants and in reducing potential pump cavitation. Capacity is 94 gal (355 liters). Swing-away hydraulic oil cooler is standard.

MAIN WINCH SPECIFICATIONS

Hydraulic winch with bent axis piston motor and planetary reduction provides 2-speed operation with equal speeds for power up and down. Winch is equipped with an integral automatic brake, a grooved drum with tapered flanges for improved rope spooling, a spring loaded cable roller and an electronic drum rotation indicator.

PERFORMANCE	LO-RANGE	HI-RANGE
Max. line speed (no load)		
First layer	205 fpm (62.5 m/min)	329 fpm (100.3 m/min)
Fifth layer	297 fpm (90.5 m/min)	475 fpm (144.8 m/min)
Max. line pull-first layer	12,512 lbs (5675 kg)	7,298 lbs (3310 kg)
Max. line pull-fifth layer	8,662 lbs (3929 kg)	5,052 lbs (2292 kg)
Permissible line pull	9,000 lbs (4082 kg)	

DRUM DIMENSIONS	DRUM CAPACITY
10.62 in (270 mm) drum diameter	Max. Storage: 598 ft (182.3 m)
17.53 in (445 mm) length	6th layer not a working layer
18.25 in (464 mm) flange dia.	Max. Useable: 479 ft (146.0 m)*
Cable: 5/8 in. x 450 ft (16 mm x 137.2 m)	
Cable type: 5/8 in. (16mm) 6x19 IWRC IPS right regular lay, preformed	* Based on min. flange height above top layer to comply with ANSI B30.5
Min. breaking strength 17.9 tons (16.2 mt).	

OPTIONAL AUXILIARY WINCH

Hydraulic winch with bent axis piston motor, power up and down, equal speed, planetary reduction with integral automatic brake, cable roller, and rotation indicator.

PERFORMANCE
(Same as main winch)
DRUM DIMENSIONS AND CAPACITY
(Same as main winch)

DRUM CAPACITY
(Same as main winch)

OPTIONAL HOIST LINE – MAIN WINCH AND OPTIONAL AUXILIARY WINCH – 5/8 in. (16 mm) rotation resistant compacted strand 18x19 or 19x19. Min. breaking strength 22.6 tons (20.6 mt).

PERFORMANCE (Standard Engine)

Transmission Range	Gear	Forward Drive	Maximum Speed	Maximum Tractive Effort @ Stall	Gradeability @ Stall
Low	1	4-wheel	2.3 mph	37,856 lbs	112.34%
			3.7 km/h	17 171 kg	
	2	4-wheel	4.4 mph	19,254 lbs	39.84%
			7.1 km/h	8734 kg	
	3	4-wheel	12.4 mph	6,431 lbs	11.10%
			20.0 km/h	2917 kg	
High	1	2-wheel	5.0 mph	16,893 lbs	34.04%
			8.0 km/h	7663 kg	
	2	2-wheel	9.5 mph	8,589 lbs	15.59%
			15.3 km/h	3896 kg	
	3	2-wheel	24.5 mph	2,849 lbs	3.77%
			39.4 km/h	1292 kg	

All performance data is based on a gross vehicle weight of 52,000 lbs (23 583 kg), 16:00 x 25 tires, 4 x 4 drive. Performance may vary due to engine performance. Gradeability data is theoretical and is limited by tire slip, stability, or engine oil pan design.

ENGINE SPECIFICATIONS

Make and Model	Standard Cummins 6BTA5.9	Optional Caterpillar 3116 DIT
Type	6 cylinder	6 cylinder
Bore and Stroke	4.02 x 4.72 in (102 x 120 mm)	4.12 x 5.0 in (105 x 127 mm)
Displacement	359 cu in (5.9 l)	402 cu in (6.6 l)
Max. Gross Horsepower	130 hp (97 kw) @ 2500 rpm	140 hp (105 kw) @ 2400 rpm
Max. Gross Torque	384 lb•ft (521 N•m) @ 1200 rpm	426 lb•ft (578 N•m) @ 1450 rpm
Aspiration	turbocharged	turbocharged
Air Filter	dry type	dry type
Electrical System	12 volt	12 volt
Alternator	102 amp	115 amp
Battery	(2) 12V-1600 C.C.A.	(2) 12V-1600 C.C.A.
Fuel Capacity	50 gal (189 l)	50 gal (189 l)



GENERAL DIMENSIONS

NOTES:

- Dimensions given assume the boom is fully retracted in travel position and 16:00 x 25 tires. 20.5 tires reduce heights 1.0 (25mm).
- Minimum ground clearance under transmission – 20.62" (0.52m)
 axle bowls – 19.12" (0.49m)
 tie rods – 20.38" (0.52m)

- Track width: 6' 7.50" (2.02m) 16:00 x 25 tires
 6' 10.5" (2.10m) 20.5 x 25 tires
- Width of carrier:
 8'0" (2.44m) 16:00 x 25 tires
 8'8" (2.64m) 20.5 x 25 tires

Tire to frame angle	16:00 tires	20.5 tires
Approach angle:	25.1°	24.1°
Departure angle:	23.1°	22.2°

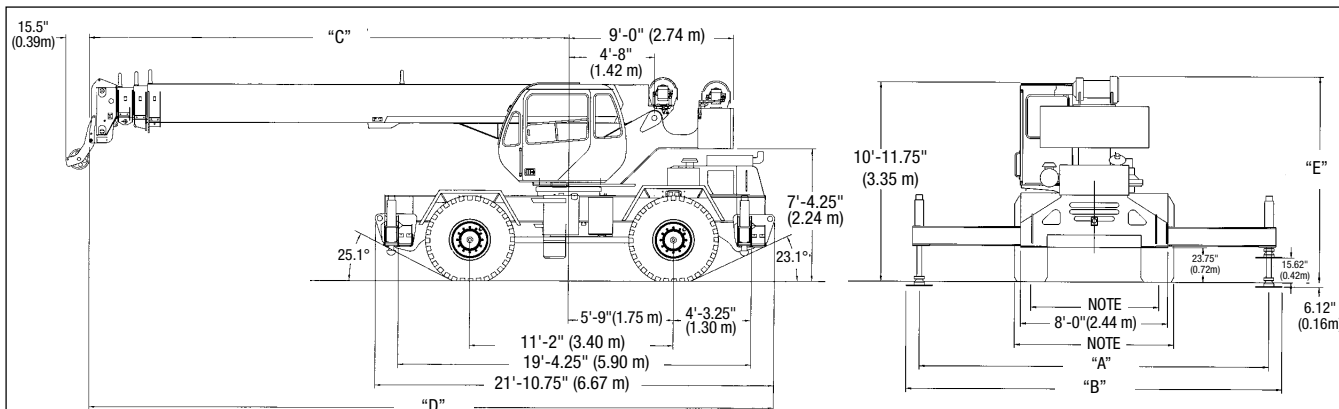

	"A"	"B"	Boom Length	"C"	"D"	"E"
Fully extended outriggers	19'-0" (5.79m)	20'-6" (6.25m)	32' (9.75m) Boom	15'-10" (4.83m)	27'-1" (8.25m)	12'-9.38" (3.90m)
Pinned outriggers	13'-2" (4.01m)	14'-8" (4.47m)	72' (22.19m) Boom	26'-4" (8.03m)	37'-7" (11.46m)	11'-7.5" (3.54m)
Fully retracted outriggers	7'-4.5" (2.25m)	8'-10.5" (2.71 m)	94' (28.78m) Boom	26'-4" (8.03m)	37'-7" (11.46m)	11'-7.5" (3.54m)
			100' (30.61m) Boom	28'-4" (8.64m)	39'-7" (12.06m)	11'-7.5" (3.54m)

WEIGHTS & AXLE LOADS	GROSS WEIGHT LBS.	UPPER FACING FRONT		GROSS WEIGHT KG.	UPPER FACING FRONT	
		FRONT	REAR		FRONT	REAR
Basic Crane with 10,000 lb. (4536 kg) Counterweight	55,930	28,972	26,958	25,369	13 141	12 228
Add Options:						
26' (7.92 m) Swing-on Jib (Stowed)	+ 1,100	+ 2,000	- 900	+ 499	+ 907	- 408
26'-43' (7.92-13.11 m) Swing-on Jib (Stowed)	+ 1,500	+ 2,600	- 1,100	+ 680	+ 1179	- 499
Auxiliary Boom Head	+ 100	+ 300	- 200	+ 45	+ 136	- 91
Auxiliary Winch with Wire Rope, Controls, Etc.	+ 115	- 25	+ 140	+ 52	- 11	+ 63
30 ton (27.2 mt) 4 Sheave Hook Block	+ 655	+ 1,071	- 416	+ 297	+ 486	- 189
30 ton (27.2 mt) 3 Sheave Hook Block	+ 670	+ 1,099	- 429	+ 304	+ 498	- 194
25 ton (22.6 mt) 2 Sheave Hook Block	+ 682	+ 1,117	- 435	+ 309	+ 507	- 198
6.25 ton (5.7 mt) Hook and Ball (in tool box)	+ 240	+ 290	- 50	+ 109	+ 130	- 21
Pintle Hook: Front	+ 45	+ 60	- 15	+ 20	+ 27	- 7
Rear	+ 45	- 25	+ 70	+ 20	- 11	+ 31
Substitute:						
72' (22.19 m) Full Power 3-section Boom	- 3,190	- 4,335	+ 1,145	- 1445	- 1965	+ 520
100' (30.61 m) Full Power 4-Section Boom	+ 533	+ 1986	- 1453	+ 242	+ 901	- 659
16.00 x 25 Tires	- 360	- 180	- 180	- 164	- 82	- 82

NOTE: Weights are for factory supplied equipment and subject to 2% variation due to manufacturing tolerances.

WE RESERVE THE RIGHT TO AMEND THESE SPECIFICATIONS AT ANY TIME WITHOUT NOTICE. THE ONLY WARRANTY APPLICABLE IS OUR STANDARD WRITTEN WARRANTY APPLICABLE TO THE PARTICULAR PRODUCT AND SALE. WE MAKE NO OTHER WARRANTY, EXPRESSED OR IMPLIED.

TEREX CRANES

106 12th Street S.E.
 Waverly, IA 50677-9466 USA
 (319) 352-3920 • FAX: (319) 352-5727
 E-mail: inquire@terexwaverly.com





TEREX RT 230XL

rough terrain crane
30 ton capacity

range diagram & lifting capacities

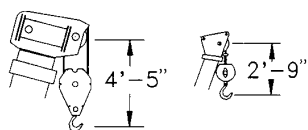

DIMENSIONS ARE FOR LARGEST FACTORY FURNISHED HOOK BLOCK AND HOOK & BALL, WITH ANTI-TWO BLOCK ACTIVATED

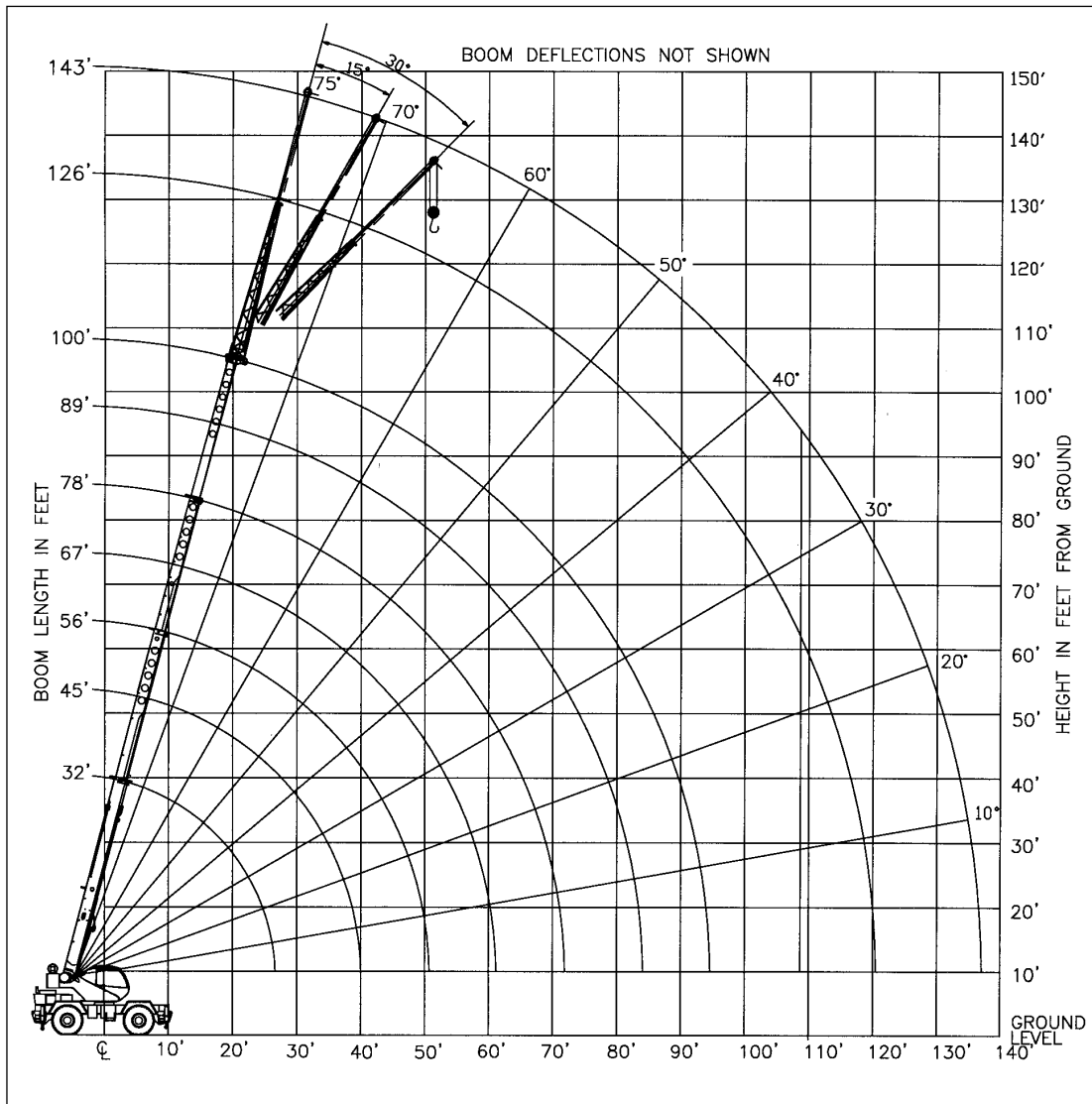

Range Diagram
(32' - 100' boom)

CRANE WORKING CONDITIONS

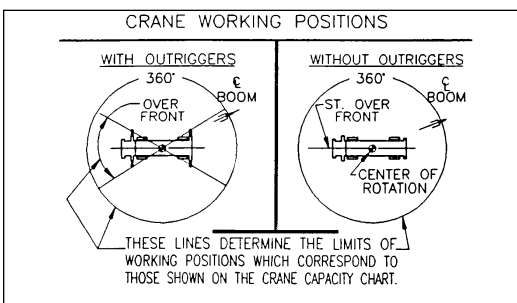

REDUCTION IN MAIN BOOM CAPACITY

All Jibs in Stowed Position	0 Lbs.
Aux. Boom in Head Sheave	100 Lbs.

HOOK BLOCK WEIGHTS

Hook & Ball	239 Lbs.
Hook Block (2 Sheave)	680 Lbs.
Hook Block (3 Sheave)	660 Lbs.
Hook Block (4 Sheave)	660 Lbs.



Lifting Capacities – Pounds (32’ – 100’ boom)

MODEL RT 230XL

COUNTERWEIGHT:
W/AUX. WINCH 8900 LBS.
W/O AUX. WINCH 10,000 LBS.
BOOM LENGTH 32-100 FT.
OUTRIGGER SPREAD 19 FT.

STABILITY PERCENTAGE
ON OUTRIGGERS 85%
ON TIRES 75%
PCSA CLASS 10-105

⚠ CAUTION: Do not use this specification sheet as a load rating chart. The format of data is not consistent with the machine chart and may be subject to change.

ON OUTRIGGERS - FULLY EXTENDED

LOAD RADIUS (FT)	BOOM LENGTH 32 FT			BOOM LENGTH 45 FT			BOOM LENGTH 56 FT			LOAD RADIUS (FT)
	LOADED BOOM ANGLE (DEG)	OVER FRONT (LB)	360° (LB)	LOADED BOOM ANGLE (DEG)	OVER FRONT (LB)	360° (LB)	LOADED BOOM ANGLE (DEG)	OVER FRONT (LB)	360° (LB)	
10	64.8	60,000*	60,000*	72.2	46,600*	46,600*				10
12	60.7	49,000*	49,000*	69.5	45,200*	45,200*	73.7	43,100*	43,100*	12
15	54.3	42,600*	42,600*	65.3	39,200*	39,200*	70.4	37,200*	37,200*	15
20	42.0	30,100*	30,100*	57.9	40,000*	40,000*	64.8	30,400*	30,400*	20
25	25.1	22,500*	22,500*	49.8	23,500*	23,500*	58.9	23,900*	23,900*	25
30				40.6	18,500*	18,500*	52.6	18,900*	18,900*	30
35				29.0	14,800*	13,900*	45.7	15,300*	14,400*	35
40				5.7	11,800*	10,500*	37.9	12,500*	11,200*	40
45							28.2	9,900*	8,800*	45
50							12.6	8,000*	7,000*	50
55										55
60										60
65										65
70										70
75										75
80										80
85										85
90										90
95										95

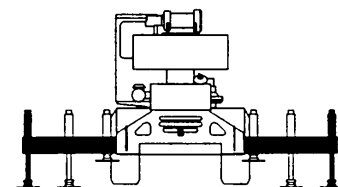

**USE THESE CHARTS ONLY
WHEN ALL OUTRIGGERS
ARE FULLY EXTENDED**

ON OUTRIGGERS - FULLY EXTENDED

LOAD RADIUS (FT)	BOOM LENGTH 67 FT			BOOM LENGTH 78 FT			BOOM LENGTH 89 FT			BOOM LENGTH 100 FT			LOAD RADIUS (FT)
	LOADED BOOM ANGLE (DEG)	OVER FRONT (LB)	360° (LB)	LOADED BOOM ANGLE (DEG)	OVER FRONT (LB)	360° (LB)	LOADED BOOM ANGLE (DEG)	OVER FRONT (LB)	360° (LB)	LOADED BOOM ANGLE (DEG)	OVER FRONT (LB)	360° (LB)	
10													10
12													12
15	73.7	35,800*	35,800*										15
20	69.2	29,100*	29,100*	72.3	27,000*	27,000*							20
25	64.5	24,200*	24,200*	68.3	22,700*	22,700*	71.1	20,400*	20,400*	73.3	15,100*	15,100*	25
30	59.6	19,200*	19,200*	64.3	19,400*	19,400*	67.7	17,500*	17,500*	70.3	12,900*	12,900*	30
35	54.4	15,600*	14,600*	60.1	15,800*	14,800*	64.1	15,000*	14,900*	67.2	11,200*	11,200*	35
40	48.9	12,700*	11,400*	55.7	12,900*	11,600*	60.5	13,000*	11,700*	64.0	9,800*	9,800*	40
45	42.8	10,300*	9,100*	51.1	10,400*	9,300*	56.6	10,500*	9,400*	60.7	8,700*	8,700*	45
50	35.9	8,400*	7,400*	46.1	8,600*	7,600*	52.7	8,700*	7,700*	57.4	7,800*	7,700*	50
55	27.6	6,900*	6,000*	40.7	7,100*	6,200*	48.4	7,200*	6,300*	53.9	7,000*	6,400*	55
60	15.4	5,600*	4,800*	34.5	5,900*	5,100*	43.9	6,000*	5,200*	50.2	6,100*	5,300*	60
65				27.2	4,900*	4,200*	39.0	5,100*	4,300*	46.3	5,200*	4,400*	65
70				17.1	4,000*	3,400*	33.4	4,200*	3,600*	42.1	4,400*	3,700*	70
75							26.9	3,500*	2,900*	37.6	3,600*	3,000*	75
80							18.2	2,900*	2,300*	32.5	3,000*	2,500*	80
85										26.6	2,500*	2,000*	85
90										19.0	2,000*	1,500*	90
95										3.5	1,600*	1,100*	95

** MAXIMUM CAPACITY AT 0 DEGREE BOOM ANGLE

BOOM LENGTH 32 FT			BOOM LENGTH 45 FT			BOOM LENGTH 56 FT			BOOM LENGTH 67 FT			BOOM LENGTH 78 FT			BOOM LENGTH 89 FT			BOOM LENGTH 100 FT		
LOAD RADIUS (FT)	OVER FRONT (LB)	360° (LB)	LOAD RADIUS (FT)	OVER FRONT (LB)	360° (LB)	LOAD RADIUS (FT)	OVER FRONT (LB)	360° (LB)	LOAD RADIUS (FT)	OVER FRONT (LB)	360° (LB)	LOAD RADIUS (FT)	OVER FRONT (LB)	360° (LB)	LOAD RADIUS (FT)	OVER FRONT (LB)	360° (LB)	LOAD RADIUS (FT)	OVER FRONT (LB)	360° (LB)
27.6	19,400*	19,400*	40.1	11,700*	10,400*	51.1	7,600*	6,600*	62.1	5,100*	4,400*	73.1	3,500*	2,900*	84.1	2,400*	1,900*	95.1	1,600*	1,100*

Lifting Capacities – Pounds (32’ – 100’ boom)

MODEL RT 230XL

COUNTERWEIGHT: W/AUX. WINCH 8900 LBS.
 W/O AUX. WINCH 10,000 LBS.
 BOOM LENGTH 32-100 FT.
 OUTRIGGER SPREAD 19 FT.

STABILITY PERCENTAGE
 ON OUTRIGGERS 85%
 ON TIRES 75%
 PCSA CLASS 10-105

CAUTION: Do not use this specification sheet as a load rating chart. The format of data is not consistent with the machine chart and may be subject to change.

ON OUTRIGGERS - MID POSITION

LOAD RADIUS (FT)	BOOM LENGTH 32 FT		BOOM LENGTH 45 FT		BOOM LENGTH 56 FT		BOOM LENGTH 67 FT		BOOM LENGTH 78 FT		BOOM LENGTH 89 FT		BOOM LENGTH 100 FT		LOAD RADIUS (FT)
	LOADED BOOM ANGLE (DEG)	360° (LB)	LOADED BOOM ANGLE (DEG)	360° (LB)	LOADED BOOM ANGLE (DEG)	360° (LB)	LOADED BOOM ANGLE (DEG)	360° (LB)	LOADED BOOM ANGLE (DEG)	360° (LB)	LOADED BOOM ANGLE (DEG)	360° (LB)	LOADED BOOM ANGLE (DEG)	360° (LB)	
10	64.8	60,000*	72.2	46,600*											10
12	60.7	49,000*	69.5	45,200*	73.7	43,100*									12
15	54.3	42,000*	65.3	39,200*	70.4	37,200*	73.7	35,800*							15
20	42.0	23,600	57.9	24,600	64.8	25,000	69.2	25,200	72.3	25,400					20
25	25.1	15,100	49.8	16,300	58.9	16,600	64.5	16,900	68.3	17,000	71.1	17,100	73.3	15,100*	25
30			40.6	11,400	52.6	11,900	59.6	12,100	64.3	12,200	67.7	12,300	70.3	12,400	30
35			29.0	8,200	45.7	8,700	54.4	8,900	60.1	9,100	64.1	9,200	67.2	9,300	35
40			5.7	5,800	37.9	6,400	48.9	6,700	55.7	6,900	60.5	7,000	64.0	7,100	40
45					28.2	4,700	42.8	5,100	51.1	5,300	56.6	5,400	60.7	5,400	45
50					12.6	3,400	35.9	3,800	46.1	4,000	52.7	4,100	57.4	4,200	50
55							27.6	2,700	40.7	3,000	48.4	3,100	53.9	3,200	55
60							15.4	1,900	34.5	2,100	43.9	2,300	50.2	2,400	60
65									27.2	1,400	39.0	1,600	46.3	1,700	65

** MAXIMUM CAPACITY AT 0 DEGREE BOOM ANGLE

BOOM LENGTH 32 FT		BOOM LENGTH 45 FT		BOOM LENGTH 56 FT		BOOM LENGTH 67 FT		BOOM LENGTH 78 FT		BOOM LENGTH 89 FT		BOOM LENGTH 100 FT	
LOAD RADIUS (FT)	360° (LB)	LOAD RADIUS (FT)	360° (LB)	LOAD RADIUS (FT)	360° (LB)	LOAD RADIUS (FT)	360° (LB)	LOAD RADIUS (FT)	360° (LB)	LOAD RADIUS (FT)	360° (LB)	LOAD RADIUS (FT)	360° (LB)
27.6	12,100	40.1	5,700	51.1	3,100	62.1	1,500						

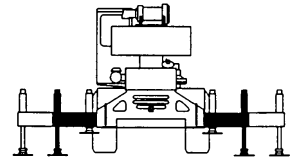

USE THESE CHARTS ONLY WHEN ALL OUTRIGGERS ARE PINNED IN MID POSITION

ON OUTRIGGERS - RETRACTED

LOAD RADIUS (FT)	BOOM LENGTH 32 FT		BOOM LENGTH 45 FT		BOOM LENGTH 56 FT		BOOM LENGTH 67 FT		BOOM LENGTH 78 FT		BOOM LENGTH 89 FT		BOOM LENGTH 100 FT		LOAD RADIUS (FT)
	LOADED BOOM ANGLE (DEG)	360° (LB)	LOADED BOOM ANGLE (DEG)	360° (LB)	LOADED BOOM ANGLE (DEG)	360° (LB)	LOADED BOOM ANGLE (DEG)	360° (LB)	LOADED BOOM ANGLE (DEG)	360° (LB)	LOADED BOOM ANGLE (DEG)	360° (LB)	LOADED BOOM ANGLE (DEG)	360° (LB)	
10	64.8	34,400	72.2	35,200											10
12	60.7	24,600	69.5	25,400	73.7	25,800									12
15	54.3	16,300	65.3	17,200	70.4	17,600	73.7	17,800							15
20	42.0	9,200	57.9	10,200	64.8	10,600	69.2	10,700	72.3	10,900					20
25	25.1	5,400	49.8	6,300	58.9	6,800	64.5	7,000	68.3	7,100	71.1	7,200	73.3	7,300	25
30			40.6	4,000	52.6	4,400	59.6	4,600	64.3	4,800	67.7	4,900	70.3	5,000	30
35			29.0	2,300	45.7	2,700	54.4	3,000	60.1	3,200	64.1	3,300	67.2	3,400	35
40			5.7	1,000	37.9	1,600	48.9	1,800	55.7	2,000	60.5	2,100	64.0	2,200	40
45							42.8	900	51.1	1,100	56.6	1,200	60.7	1,400	45

** MAXIMUM CAPACITY AT 0 DEGREE BOOM ANGLE

BOOM LENGTH 32 FT		BOOM LENGTH 45 FT		BOOM LENGTH 56 FT		BOOM LENGTH 67 FT		BOOM LENGTH 78 FT		BOOM LENGTH 89 FT		BOOM LENGTH 100 FT	
LOAD RADIUS (FT)	360° (LB)	LOAD RADIUS (FT)	360° (LB)	LOAD RADIUS (FT)	360° (LB)	LOAD RADIUS (FT)	360° (LB)	LOAD RADIUS (FT)	360° (LB)	LOAD RADIUS (FT)	360° (LB)	LOAD RADIUS (FT)	360° (LB)
27.6	3,800	40.1	900										

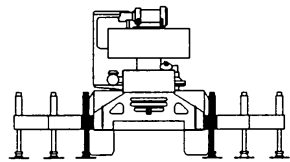

USE THESE CHARTS WHEN ALL OUTRIGGER BEAMS ARE NOT IN EITHER THE MID OR FULLY EXTENDED POSITION



Lifting Capacities – Pounds (32’ – 100’ boom)

MODEL RT 230XL

COUNTERWEIGHT:
W/AUX. WINCH 8900 LBS.
W/O AUX. WINCH 10,000 LBS.
BOOM LENGTH 32-100 FT.
OUTRIGGER SPREAD 19 FT.

STABILITY PERCENTAGE
ON OUTRIGGERS 85%
ON TIRES 75%
PCSA CLASS 10-105

CAUTION: Do not use this specification sheet as a load rating chart. The format of data is not consistent with the machine chart and may be subject to change.

SIDE STOW JIB ON FULLY EXTENDED OUTRIGGERS

LOADED BOOM ANGLE (DEG)	26 FT OFFSETTABLE JIB						43 FT OFFSETTABLE JIB						LOADED BOOM ANGLE (DEG)
	0° OFFSET		15° OFFSET		30° OFFSET		0° OFFSET		15° OFFSET		30° OFFSET		
	LOAD RADIUS (REF) (FT)	360° (LB)	LOAD RADIUS (REF) (FT)	360° (LB)	LOAD RADIUS (REF) (FT)	360° (LB)	LOAD RADIUS (REF) (FT)	360° (LB)	LOAD RADIUS (REF) (FT)	360° (LB)	LOAD RADIUS (REF) (FT)	360° (LB)	
75	37	9,100*	43	7,400*	47	5,600*	41	5,100*	51	3,400*	59	2,700*	75
73	41	8,600*	46	6,800*	51	5,300*	46	4,800*	56	3,300*	63	2,700*	73
71	44	8,100*	50	6,300*	55	5,000*	51	4,500*	61	3,200*	67	2,600*	71
68	50	7,300*	55	5,600*	60	4,500*	58	4,100*	67	3,000*	74	2,500*	68
65	56	6,300*	60	5,100*	65	4,100*	64	3,800*	74	2,900*	80	2,500*	65
62	61	5,500*	65	4,500*	70	3,700*	70	3,600*	79	2,800*	85	2,400*	62
59	66	4,000*	70	3,900*	74	3,300*	76	3,400*	85	2,700*	90	2,400*	59
55	73	3,100*	77	3,200*	80	2,800*	83	2,900*	91	2,600*	96	2,300*	55
51	80	2,500*	84	2,600*	86	2,300*	90	2,300*	98	2,100*	102	2,000*	51
47	86	2,000*	90	2,000*	92	1,800*	98	1,900*	106	1,700*	108	1,600*	47
43	93	1,500*	96	1,500*	98	1,400*	106	1,400*	112	1,300*	114	1,200*	43
38	100	1,000*	102	1,000*	103	1,000*	115	1,000*	119	900*			38

NOTES FOR JIB CAPACITIES

- A. For all boom lengths less than the maximum with a jib erected, the rated loads are determined by boom angle only in the appropriate column.
- B. For boom angle not shown, use the capacity of the next lower boom angle.
- C. Listed radii are for extended main boom only.

ON TIRES

RADIUS (FT)	MAX BOOM LENGTH (FT)	16:00 X 25-28PR				20:50 X 25-24PR				RADIUS (FT)
		STATIONARY		PICK & CARRY		STATIONARY		PICK & CARRY		
		360°	STRAIGHT OVER FRONT	CREEP	2.5 MPH	360°	STRAIGHT OVER FRONT	CREEP	2.5 MPH	
10	32	27,700*	44,100	35,800*	26,200*	26,700*	43,800*	34,400*	23,400*	10
12	32	20,600*	37,700	30,700*	22,200*	20,000*	37,900*	29,500*	19,800*	12
15	32	14,500*	27,900	25,000*	17,800*	14,000*	30,300*	24,000*	15,700*	15
20	45	8,100*	17,600	17,600	12,800*	8,200*	17,500	17,500	11,100*	20
25	45	5,400*	11,200	11,200	9,300*	5,400*	11,100	11,100	7,900*	25
30	45	3,400*	8,000	8,000	6,900*	3,500*	7,800	7,800	5,700*	30
35	56	2,000*	6,100	6,100	5,500*	2,200*	6,000	6,000	4,400*	35
40	56	1,300*	4,800	4,800	4,300*	1,400*	4,600	4,600	3,400*	40
45	56		3,800	3,800	3,400*	800*	3,600	3,600	2,600*	45
50	67		2,900	2,700	2,700*		2,800	2,800	1,900*	50
55	67		2,100	2,100	2,100*		2,100	2,100	1,400*	55
60	67		1,500	1,500	1,500*		1,500	1,500	900*	60

NOTES FOR ON TIRE CAPACITIES

- A. For Pick and Carry operations, boom must be centered over the rear of the crane with swing brake and lock engaged. Use minimum boom point height and keep load close to ground surface. Travel must be on smooth level surface.
- B. The load should be restrained from swinging. NO ON TIRE OPERATION WITH JIB ERECTED.
- C. Without outriggers, never maneuver the boom beyond listed load radii for applicable tires to ensure stability.
- D. Creep speed is crane movement of less than 200 Ft. (61m) in a 30 minute period and not exceeding 1.0 mph(1.6 km/h).
- E. Refer to General Notes for additional information.

MAXIMUM PERMISSIBLE HOIST LINE LOAD

LINE PARTS	1	2	3	4	5	6	7
MAX. LOAD	9,080	18,160	27,240	36,320	45,400	54,480	63,560
BOOM HEAD	2	3-D	2-3	1-4-D	2-3-4	2-3-4-D	1-2-3-4
HOOK BLOCK	D	3	3-D	1-4	2-3-D	2-3-4	2-3-4-D
	WIRE ROPE: 5/8" ROTATION RESISTANT COMPACTED STRAND, 18X19 OR 19X19 MINIMUM BREAKING STRENGTH - 22.7 TONS 5/8" 6X19 OR 6X37 IWRC IPS PREFORMED RIGHT REGULAR LAY MINIMUM BREAKING STRENGTH - 17.9 TONS						

RECOMMENDED TIRE PRESSURE

TIRE SIZE	STATIONARY	CREEP	2 1/2 MPH	TRAVEL
16:00 X 25-28PR	115 PSI	115 PSI	95 PSI	95 PSI
20:50 x 25-24PR	95 PSI	95 PSI	70 PSI	70 PSI

GENERAL NOTES

GENERAL

1. Rated loads as shown on Lift Charts pertain to this machine as originally manufactured and equipped. Modifications to the machine or use of optional equipment other than that specified can result in a reduction of capacity.
2. Construction equipment can be hazardous if improperly operated or maintained. Operation and maintenance of this machine shall be in compliance with the information in the Operator's, Parts and Safety Manuals supplied with this machine. If these manuals are missing, order replacements from the manufacturer through your distributor.
3. These warnings do not constitute all of the operating conditions for the crane. The operator and job site supervision must read the OPERATORS MANUAL, CIMA SAFETY MANUAL, APPLICABLE OSHA REGULATIONS, AND SOCIETY OF MECHANICAL ENGINEERS (ASME) SAFETY STANDARDS FOR CRANES.
4. This crane and its load ratings are in accordance with POWER CRANE & SHOVEL ASSOCIATION, STANDARD NO. 4, SAE CRANE LOAD STABILITY TEST CODE J765A, SAE METHOD OF TEST FOR CRANE STRUCTURE J1063 AND APPLICABLE SAFETY CODE FOR CRANES, DERRICKS AND HOISTS, ASME/ANSI B30.5.

DEFINITIONS

1. **LOAD RADIUS** – The horizontal distance from the axis of rotation before loading to the center of the vertical hoist line or tackle with a load applied.
2. **LOADED BOOM ANGLE** – It is the angle between the boom base section and the horizontal, after lifting the rated load at the rated radius. The boom angle before loading should be greater to account for deflections. The loaded boom angle combined with boom length give only an approximation of the operating radius.
3. **WORKING AREA** – Areas measured in a circular arc about the centerline of rotation as shown in the diagram.
4. **FREELY SUSPENDED LOAD** – Load hanging free with no direct external force applied except by the hoist rope.
5. **SIDE LOAD** – Horizontal force applied to the lifted load either on the ground or in the air.
6. **NO LOAD STABILITY LIMIT** – The stability limit radius shown on the range diagrams is the radius beyond which it is not permitted to position the boom, when the boom angle is less than the minimum shown on the applicable load chart, because the machine can overturn without any load.
7. **BOOM SIDE OF CRANE** – The side of the crane over which the boom is positioned when in an OVER SIDE working position.

SET-UP

1. Crane load ratings are based on the crane being leveled and standing on a firm, uniform supporting surface.
2. Crane load ratings on outriggers are based on all outrigger beams being fully extended or in the case of partial extension ratings mechanically pinned in the appropriate position, and the tires free of the supporting surface.
3. Crane load ratings on tires depend on appropriate inflation pressure and the tire conditions. Caution must be exercised when increasing air pressures in tires. Consult Operator's Manual for precautions.
4. Use of jibs, lattice-type boom extensions, or fourth section pullouts extended is not permitted for pick and carry operations.
5. Consult appropriate section of the Operator's and Service Manual for more exact description of hoist line reeving.
6. The use of more parts of line than required by the load may result in having insufficient rope to allow the hook block to reach the ground.
7. Properly maintained wire rope is essential for safe crane operation. Consult Operator's Manual for proper maintenance and inspection requirements.
8. When spin-resistant wire rope is used, the allowable rope loading shall be the breaking strength divided by five (5), unless otherwise specified by the wire rope manufacturer.
9. Do not elevate the boom above 60° unless the boom is positioned in-line with the crane's chassis or the outriggers are extended. Failure to observe this warning may result in loss of stability.

OPERATION

1. **CRANE LOAD RATINGS MUST NOT BE EXCEEDED. DO NOT ATTEMPT TO TIP THE CRANE TO DETERMINE ALLOWABLE LOADS.**
2. When either radius or boom length, or both, are between listed values, the smaller of the two listed load ratings shall be used.
3. Do not operate at longer radii than those listed on the applicable load rating chart (cross hatched areas shown on range diagrams).
4. The boom angles shown on the Capacity Chart give an approximation of the operating radius for a specified boom length. The boom angle, before loading, should be greater to account for boom deflection. It may be necessary to retract the boom if maximum boom angle is insufficient to maintain rated radius.
5. Power telescoping boom sections must be extended equally.
6. Rated loads include the weight of hook block, slings, and auxiliary lifting devices. Their weights shall be subtracted from the listed rated load to obtain the net load that can be lifted.

When lifting over the jib the weight of any hook block, slings, and auxiliary lifting devices at the boom head must be added to the load.

When jibs are erected but unused add two (2) times the weight of any hook block, slings, and auxiliary lifting devices at the jib head to the load.

7. Rated loads do not exceed 85% on outriggers or 75% on tires, of the tipping load as determined by SAE Crane Stability Test Code J765a. Structural strength ratings in chart are indicated with an asterisk (*).
8. Rated loads are based on freely suspended loads. No attempt shall be made to drag a load horizontally on the ground in any direction.
9. The user shall operate at reduced ratings to allow for adverse job conditions, such as: Soft or uneven ground, out of level conditions, high winds, side loads, pendulum action, jerking or sudden stopping of loads, hazardous conditions, experience of personnel, two machine lifts, traveling with loads, electric wires, etc., (side pull on boom or jib is hazardous). Derating of the cranes lifting capacity is required when wind speed exceeds 20 MPH. The center of the lifted load must never be allowed to move more than 3* feet off the center line of the base boom section due to the effects of wind, inertia, or any combination of the two.
 **"Use 2 feet off the center line of the base boom for a two section boom, 3 feet for a three section boom, or 4 feet for a four section boom."
10. The maximum load which can be telescoped is not definable, because of variations in loadings and crane maintenance, but it is permissible to attempt retraction and extension if load ratings are not exceeded.
11. Load ratings are dependent upon the crane being maintained according to manufacturer's specifications.
12. It is recommended that load handling devices, including hooks, and hook blocks, be kept away from boom head at all times.
13. **FOR TRUCK CRANES ONLY:** 360° capacities apply only to machines equipped with a front outrigger jack and all five (5) outrigger jacks properly set. If the front (5th) outrigger jack is not properly set, the work area is restricted to the over side and over rear areas as shown on the Crane Working Positions diagram. Use the 360° load ratings in the overside work areas.
14. Do not lift with outrigger beams positioned between the fully extended and intermediate (pinned) positions.
15. Truck Cranes not equipped with equalizing (bogie) beams between the rear axles may not be used for lifting "on tires". Truck Cranes equipped with equalizing beams and rear air suspension should "dump" the air before lifting "on tires".

CLAMSHELL, MAGNET, AND CONCRETE BUCKET SERVICE

1. Maximum boom length for clamshell and magnet service is 50 feet.
2. Weight of clamshell or magnet, plus contents are not to exceed 6,000 pounds or 90% of rated lifting capacities, whichever is less. For concrete bucket operation, weight of bucket and load must not exceed 90% of rated lifting capacity.



WE RESERVE THE RIGHT TO AMEND THESE SPECIFICATIONS AT ANY TIME WITHOUT NOTICE. THE ONLY WARRANTY APPLICABLE IS OUR STANDARD WRITTEN WARRANTY APPLICABLE TO THE PARTICULAR PRODUCT AND SALE. WE MAKE NO OTHER WARRANTY, EXPRESSED OR IMPLIED.

Bigge Crane and Rigging Co.

10700 Bigge Avenue
San Leandro, CA 94577
Phone: (888) 337-BIGGE or (510) 638-8100
Fax: (510) 639-4053
Email: info@bigge.com
Web site: www.bigge.com

**TEREX CRANES**

106 12th Street S.E.
Waverly, IA 50677-9466 USA
(319) 352-3920 • FAX: (319) 352-5727
E-mail: inquire@terexwaverly.com



www.terexlift.com

