

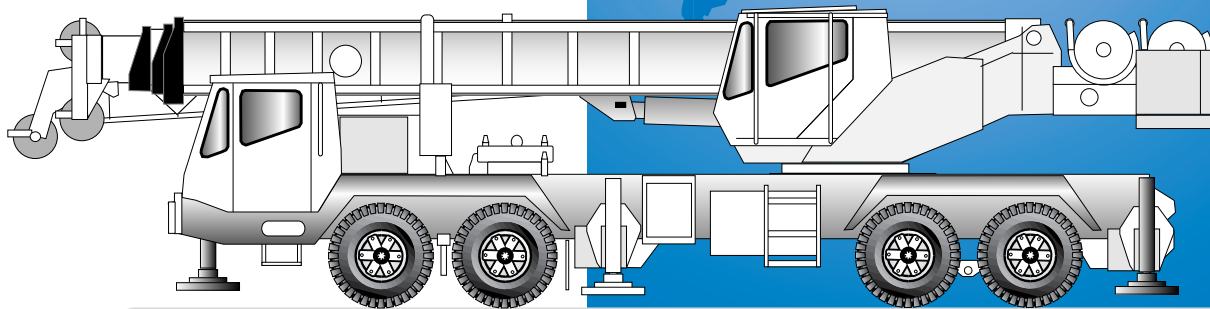

TMS640



Carrier-Mounted Hydraulic Crane



Dimensions

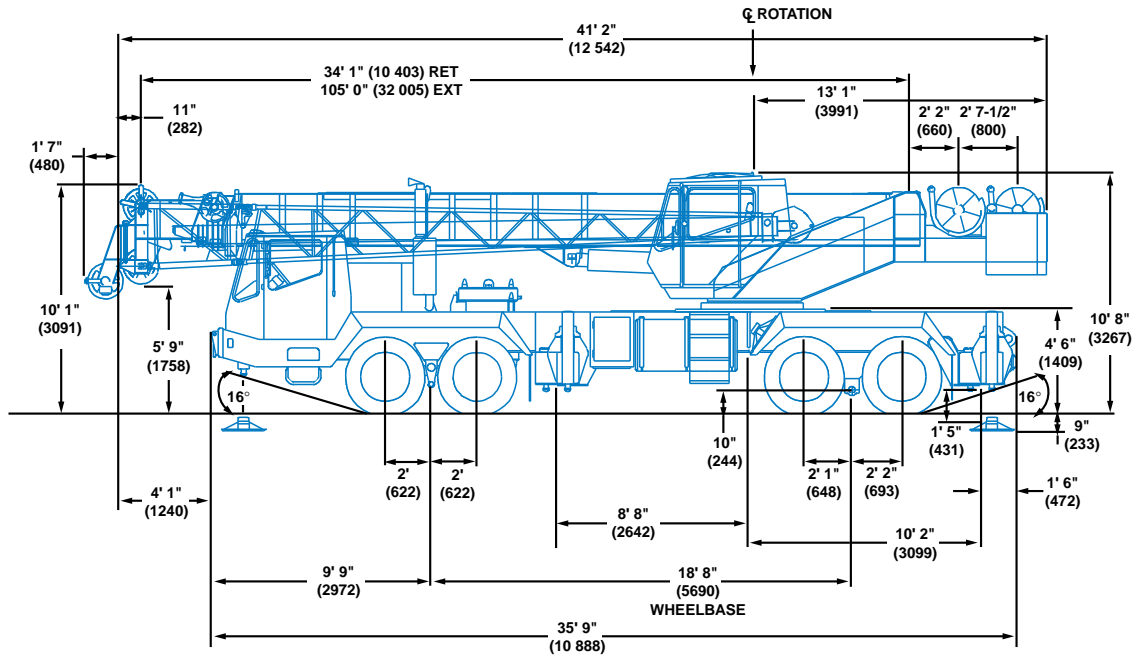
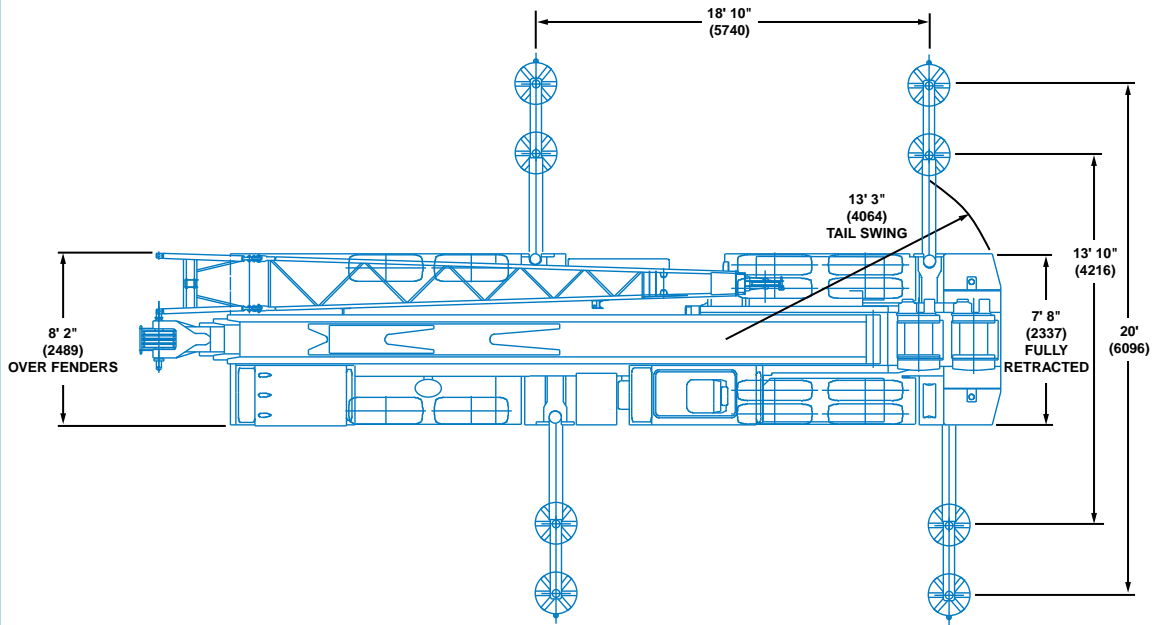

Working Range

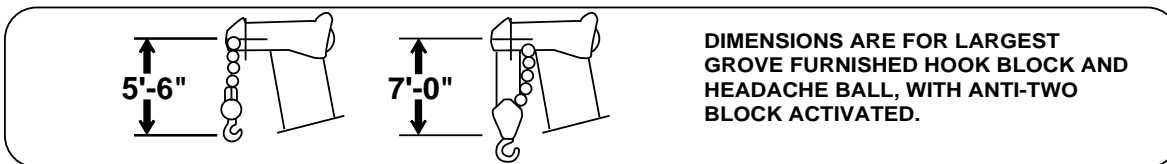
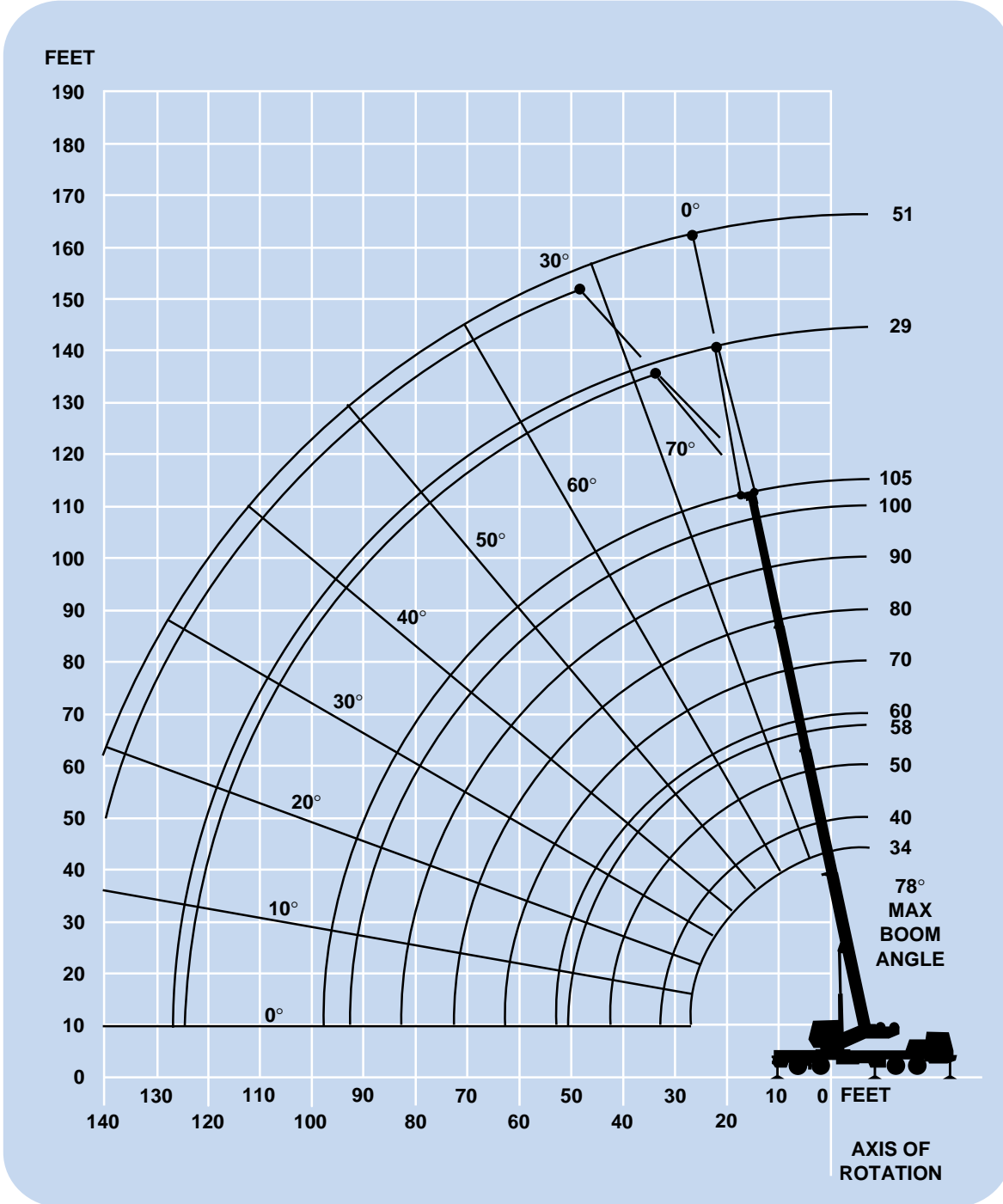

Superstructure specifications

Boom

34 ft. - 105 ft. (10.4 m - 32 m) four-section full power boom.

Maximum tip height: 112 ft. (34.0 m)

Telescopic Swingaway Extension

29 ft. to 51 ft. (8.8 m to 15.5 m) telescopic lattice swingaway extension offsettable at 0° and 30°. Stows alongside base boom section.

Maximum tip height: 163 ft. (49.7 m)

*Optional Fixed Swingaway Extension

29 ft. (8.8 m) lattice swingaway boom extension offsettable at 0° and 30°. Stows alongside base boom section.

Maximum tip height: 141 ft. (42.9 m)

Boom Nose

Three sheaves mounted on heavy duty tapered roller bearings with removable pin-type rope guards. Quick reeve boom nose. *Optional removable auxiliary boom nose with removable pin type rope guard.

Boom Elevation

One double acting hydraulic cylinder with integral holding valve provides elevation from -1° to 78°.

Load Moment & Anti-Two Block System

Standard load moment and anti-two block system with audio-visual warning and control lever lock-out. These systems provide electronic display of boom angle, length, radius, tip height, relative load moment, maximum permissible load and warning of impending two-block conditions.

Cab

Full vision, all steel fabricated with acoustical lining and tinted safety glass throughout. Deluxe seat incorporates armrest mounted hydraulic single axis controls. Dash panel incorporates gauges for all engine functions. Other standard features include: sliding side and rear windows, electric windshield wash-wipe, circulating air fan, opening skylight with electric skylight wiper, swing horn, fire extinguisher and seat belt.

Swing

Planetary swing with foot applied multi-disc wet brake. Spring applied, hydraulically released parking brake and plunger type, mechanical house lock, operated from cab.

Maximum speed: 2.5 RPM.

Counterweight

Integral with superstructure, plus one hydraulically removable section @ 3,900 lbs. (1769 kg) pinned to turntable.

Hydraulic System

6 section with a combined capacity of 201 G.P.M. (762 LPM) driven by carrier engine through P.T.O. Standard pump disconnect for travel.

Three individual valve banks.

Return line type filter with full flow by-pass protection and service indicator. Replaceable cartridge with micron filtration rating of 5/12/16.

195 gallon (738 L) reservoir.

Remote-mounted oil cooler with thermostatically controlled electric motor driven fan.

HOIST SPECIFICATIONS Main and Auxiliary Hoist

Planetary reduction with automatic spring applied multi-disc brake. Power up and down equal speed. Grooved drum. Electronic hoist drum rotation indicator.

	High Range	Low Range
Maximum Single Line Speed: (1st Layer)	347 FPM (105 m/min)	161 FPM (49 m/min)
(2nd Layer)	378 FPM (115 m/min)	175 FPM (53 m/min)
(3rd Layer)	408 FPM (124 m/min)	189 FPM (57 m/min)
(4th Layer)	439 FPM (133 m/min)	203 FPM (61 m/min)
(5th Layer)	469 FPM (142 m/min)	217 FPM (66 m/min)
Maximum Single Line Pull: (1st Layer)	8,254 lbs. (3744 kg)	16,508 lbs. (7488 kg)
(2nd layer)	7,587 lbs. (3441 kg)	15,173 lbs. (6882 kg)
(3rd layer)	7,019 lbs. (3183 kg)	14,038 lbs. (6367 kg)
(4th layer)	6,530 lbs. (2962 kg)	13,061 lbs. (5924 kg)
(5th layer)	6,105 lbs. (2769 kg)	12,211 lbs. (5538 kg)

Maximum Permissible Line Pull w/5:1 Wire Rope Strength Factor: 12,920 lbs. (5860 kg)

Maximum Rope Stowage: 694 ft. (211 m) 3/4 in. (19 mm)

Note: 450 ft. (137 m) length wire rope supplied with basic standard unit.

**Denotes optional equipment*

Carrier specifications

Chassis

Box section frame fabricated from high strength alloy steel. Integral outrigger housings and front/rear lifting, towing and tie down lugs.

Outrigger System

Hydraulic single stage, double box beam outriggers with inverted jack and integral holding valves. Three position setting. All steel fabricated, quick release type outrigger floats, 24 in. (610 mm) in diameter.

Maximum outrigger pad load: 67,592 lbs. (30 659 kg).

Outrigger Controls

Controls and crane level indicator located in superstructure cab.

Engine

Cummins 6CTA8.3, six cylinder, turbocharged and after cooled diesel, 505 cu. in. (8.3 L), 250 bhp (186 kW) (gross) @ 2,400 RPM.

Maximum torque: 660 ft. lbs. (895 Nm) @ 1,300 RPM.

Fuel Tank Capacity

100 gallons (376 L).

Electrical System

Two 12 V - maintenance free batteries. 12 V lighting and 12 V starting.

Drive

8 x 4

Steering

Front axles, mechanical with hydraulic power assist controlled by steering wheel.

Transmission

Roadranger 13 speeds forward and 3 reverse.

Axles

Front: (2) beam type steering axles, 82 in. (2.08 m) track.

Rear: (2) single reduction drive, 72.1 in. (1.83 m) track. Inter-axle differential lock.

Brakes

Dual line air system operating on all wheels. Spring-applied, air released. Parking brake acting on rear axles. Air dryer standard.

Tires

Front: 425/65R22.5 radial highway tread tubeless singles.

Rear: 11:00 x 20-14PR highway tread tube type duals.

Suspension

Front: Spring mounted tandem.

Rear: Solid mount tandem with equalizing beam and solid steel saddles.

Lights

Full lighting package including turn indicators, head and tail lights, brake and hazard warning lights.

Cab

One man design, all steel fabricated with acoustical lining and tinted safety glass throughout. Deluxe fabric covered, fully adjustable seat. Complete driving controls and engine instrumentation, including tilt telescope steering wheel, tachometer, speedometer, voltmeter, water temp., oil pressure, fuel level, dual air pressure gauges with A/V warning, engine high temp./low oil pressure A/V warning. Other standard items include hot water heater/defroster, electric windshield wash/wipe, fire extinguisher, seat belt, door and window locks.

Maximum Speed

50 mph (80 kph)

Gradeability (Theoretical)

40% (Based on 72,000 lbs. [32 659 kg] GVW)

Gross Vehicle Weight

Basic unit 72,225 lbs. (32 761 kg).

Miscellaneous Standard Equipment

Full width aluminum fenders, dual rear view mirrors, electronic back-up alarm, sling/tool box, pump disconnect, tire inflation kit, air cleaner restriction indicator, block and ball stowage, and chrome muffler guard.

*Optional Equipment

- * Auxiliary hoist
- * Amber flashing light
- * Cab spotlight
- * Engine block heater
- * Hookblocks
- * Pintle hook-rear
- * 360° position positive houseslock
- * Exhaust brake
- * Dual axis controls
- * Outrigger controls on chassis
- * Air/electric connections for trailing boom
- * 12.00R20 tube-type and 12R22.5 tubeless rear tires

**Denotes optional equipment*



34 - 105 ft.
(10.4 - 32.0 m)



3,900 lbs.
(1769 kg)



100%



360°



85% Domestic (Pounds)

(Feet)	34	40	50	*58	60	70	80	90	100	105
10	80,000	66,900	58,650	44,600	29,300					
12	66,900	65,150	55,000	44,600	29,300	@29,300				
15	58,000	56,600	48,000	41,500	29,300	29,300	@29,300			
20	45,500	45,300	38,500	35,900	29,300	29,300	29,300	27,000	@18,550	@15,850
25	34,400	34,400	32,400	30,500	29,300	27,950	26,350	23,250	18,550	15,850
30		25,750	25,500	25,300	25,300	24,000	22,950	20,300	16,500	15,850
35			19,650	19,500	19,500	19,500	19,500	17,950	14,800	14,350
40			15,500	15,150	15,250	15,700	16,150	16,000	13,400	12,850
45				11,950	12,050	12,450	12,950	13,400	12,500	11,550
50				9,470	9,590	10,050	10,500	11,000	11,500	10,400
55						8,200	8,650	9,120	9,600	9,450
60						6,640	7,140	7,600	8,080	8,320
65							5,890	6,360	6,830	7,070
70							4,830	5,330	5,800	6,030
75								4,440	4,920	5,150
80								3,660	4,170	4,400
85									3,490	3,750
90									2,900	3,150
95										2,630
Minimum boom angle (deg.) for indicated length (no load)										15
Maximum boom length (ft.) at 0 deg. boom angle (no load)										100
@ This capacity is based upon maximum boom angle.										
*58 ft. boom length is with inner-mid extended and outer-mid & fly retracted.										

A6-829-014681

THIS CHART IS ONLY A GUIDE AND SHOULD NOT BE USED TO OPERATE THE CRANE. The individual crane's load chart, operating instructions and other instructional plates must be read and understood prior to operating the crane.





34 - 105 ft.
(10.4 - 32.0 m)



0 lbs.
(0 kg)



100%



360°



85% Domestic (Pounds)

(Feet)	34	40	50	*58	60	70	80	90	100	105
10	80,000	66,900	58,650	44,600	29,300					
12	66,900	65,150	55,000	44,600	29,300	@29,300				
15	58,000	56,600	48,000	41,500	29,300	29,300	@29,300			
20	43,600	43,350	38,500	35,900	29,300	29,300	29,300	27,000	@18,550	@15,850
25	<u>31,450</u>	31,200	30,900	30,500	29,300	27,950	26,350	23,250	18,550	15,850
30		<u>23,000</u>	22,750	<u>22,550</u>	<u>22,550</u>	<u>22,550</u>	<u>22,550</u>	20,300	16,500	15,850
35			<u>17,350</u>	<u>16,800</u>	<u>16,900</u>	<u>17,350</u>	<u>17,850</u>	<u>17,950</u>	14,800	14,350
40			13,250	12,800	12,900	13,300	13,800	14,300	<u>13,400</u>	12,850
45				9,920	10,000	10,450	10,900	11,400	<u>11,900</u>	<u>11,550</u>
50				7,690	7,820	8,300	8,760	9,230	9,730	<u>9,970</u>
55						6,620	7,070	7,540	8,020	8,270
60						5,220	5,720	6,180	6,660	6,900
65							4,600	5,070	5,540	5,780
70							3,640	4,150	4,610	4,850
75								3,350	3,830	4,060
80								2,650	3,150	3,390
85									2,550	2,800
90									2,010	2,260
95										1,790

Minimum boom angle (deg.) for indicated length (no load) 15

Maximum boom length (ft.) at 0 deg. boom angle (no load) 100

@ This capacity is based upon maximum boom angle.

*58 ft. boom length is with inner-mid extended and outer-mid & fly retracted.

A6-829-014682

THIS CHART IS ONLY A GUIDE AND SHOULD NOT BE USED TO OPERATE THE CRANE. The individual crane's load chart, operating instructions and other instructional plates must be read and understood prior to operating the crane.





34 - 105 ft.
(10.4 - 32.0 m)



3,900 lbs.
(1769 kg)



50%



360°



(Feet)



SAEJ1289 APR81

(Feet)	34	40	50	*58	60	70	80	90	100	105	
10	66,650	66,450	58,650	44,600	29,300						
12	58,000	57,800	55,000	44,600	29,300	@ 29,300					
15	48,600	48,400	47,450	41,500	29,300	29,300	@ 29,300				
20	31,500	30,750	29,650	28,900	29,000	28,750	28,250	27,000	@ 18,550	@ 15,850	
25	20,900	20,350	19,450	18,850	18,950	19,400	19,900	20,350	18,550	15,850	
30		14,400	13,650	13,150	13,250	13,650	14,150	14,600	15,100	15,350	
35			9,970	9,480	9,570	10,000	10,450	10,900	11,350	11,600	
40			7,320	6,910	7,000	7,430	7,870	8,330	8,790	9,030	
45				5,010	5,110	5,530	5,970	6,420	6,880	7,110	
50				3,480	3,600	4,080	4,510	4,960	5,410	5,630	
55						2,920	3,360	3,800	4,240	4,470	
60						1,940	2,420	2,850	3,300	3,520	
65							1,620	2,070	2,520	2,740	
70								1,420	1,860	2,080	
75									1,300	1,520	
80										1,030	
Minimum boom angle (deg.) for indicated length (no load)								26	33	36	37
Maximum boom length (ft.) at 0 deg. boom angle (no load)								70			

@ This capacity is based upon maximum boom angle.

*58 ft. boom length is with inner-mid extended and outer-mid & fly retracted.

A6-829-014683



34 - 105 ft.
(10.4 - 32.0 m)



0 lbs.
(0 kg)



50%



360°



(Feet)



SAEJ1289 APR81

(Feet)	34	40	50	*58	60	70	80	90	100	105	
10	65,100	64,900	58,650	44,600	29,300						
12	56,500	56,300	55,000	44,600	29,300	@ 29,300					
15	47,300	44,650	41,050	38,750	29,300	29,300	@ 29,300				
20	27,100	26,350	25,250	24,550	24,650	24,600	24,250	23,800	@ 18,550	@ 15,850	
25	17,750	17,200	16,300	15,650	15,750	16,200	16,700	17,200	17,200	15,850	
30		11,950	11,200	10,650	10,750	11,200	11,650	12,100	12,600	12,850	
35			7,930	7,430	7,520	7,960	8,410	8,870	9,340	9,580	
40			5,580	5,180	5,270	5,690	6,140	6,590	7,060	7,290	
45				3,500	3,610	4,030	4,460	4,910	5,370	5,600	
50				2,150	2,270	2,750	3,180	3,620	4,070	4,300	
55						1,720	2,160	2,600	3,050	3,270	
60							1,330	1,770	2,220	2,440	
65								1,090	1,530	1,750	
70										1,170	
Minimum boom angle (deg.) for indicated length (no load)							28	34	40	44	46
Maximum boom length (ft.) at 0 deg. boom angle (no load)							60				

@ This capacity is based upon maximum boom angle.

*58 ft. boom length is with inner-mid extended and outer-mid & fly retracted.

A6-829-014684

THIS CHART IS ONLY A GUIDE AND SHOULD NOT BE USED TO OPERATE THE CRANE. The individual crane's load chart, operating instructions and other instructional plates must be read and understood prior to operating the crane.





34 - 105 ft.
(10.4 - 32.0 m)



3,900 lbs.
(1769 kg)



0%



360°



SAEJ1289 APR81

(Feet)	34	40	50	*58	60	70	80	90	100	105
10	44,100	41,450	37,700	35,350	29,300					
12	34,200	32,500	29,750	28,000	27,850					
15	23,700	23,000	21,900	20,750	20,750	20,500				
20	14,350	13,750	12,900	12,250	12,350	12,750	13,150	13,600		
25	9,390	8,910	8,140	7,610	7,700	8,100	8,510	8,940	9,370	9,590
30		5,870	5,210	4,730	4,810	5,210	5,620	6,040	6,470	6,690
35			3,210	2,770	2,850	3,250	3,660	4,080	4,500	4,720
40			1,720	1,350	1,430	1,830	2,240	2,660	3,080	3,300
45							1,160	1,580	2,000	2,220
50									1,160	1,370
Minimum boom angle (deg.) for indicated length (no load)			20	32	41	48	53	56	58	60
Maximum boom length (ft.) at 0 deg. boom angle (no load)						40				

*58 ft. boom length is with inner-mid extended and outer-mid & fly retracted.

A6-829-014685



34 - 105 ft.
(10.4 - 32.0 m)



0 lbs.
(0 kg)



0%



360°



SAEJ1289 APR81

(Feet)	34	40	50	*58	60	70	80	90	100	105
10	37,050	34,700	31,400	29,300	29,050					
12	28,500	27,000	24,550	23,000	22,900					
15	19,400	18,650	17,600	16,750	16,750	16,700				
20	11,400	10,800	9,920	9,310	9,400	9,800	10,200	10,650		
25	7,120	6,640	5,870	5,340	5,430	5,830	6,240	6,670	7,100	7,320
30		4,030	3,370	2,890	2,970	3,370	3,780	4,210	4,640	4,850
35			1,670	1,220	1,310	1,700	2,110	2,540	2,960	3,180
40								1,330	1,750	1,970
45										1,050
Minimum boom angle (deg.) for indicated length (no load)			34	42	48	54	59	62	64	64
Maximum boom length (ft.) at 0 deg. boom angle (no load)						40				

*58 ft. boom length is with inner-mid extended and outer-mid & fly retracted.

A6-829-014686

THIS CHART IS ONLY A GUIDE AND SHOULD NOT BE USED TO OPERATE THE CRANE. The individual crane's load chart, operating instructions and other instructional plates must be read and understood prior to operating the crane.

TMS640

9





34 - 105 ft.
(10.4 - 32.0 m)



29 - 51 ft.
(8.8 - 15.5 m)



3,900 lbs.
(1769 kg)



100%



360°



85% Domestic (Pounds)

(Feet)	RETRACTED 29' LENGTH		EXTENDED 51' LENGTH	
	0° OFFSET	30° OFFSET	0° OFFSET	30° OFFSET
30	9,000			
35	8,600		*5,060	
40	8,250	*5,000	4,900	
45	7,500	4,800	4,700	
50	6,850	4,600	4,400	
55	6,250	4,400	4,000	*2,800
60	5,600	4,350	3,800	2,700
65	5,000	4,300	3,700	2,600
70	4,450	4,250	3,500	2,500
75	4,000	4,200	3,400	2,400
80	3,550	3,800	3,300	2,350
85	3,150	3,300	3,100	2,300
90	2,800	2,900	2,900	2,250
95	2,500	2,500	2,700	2,200
100	2,150	2,190	2,350	2,150
105	1,750	1,770	2,050	2,150
110	1,390	1,390	1,820	1,820
115			1,440	1,440
120			1,090	1,090

*This capacity is based upon maximum boom angle.

A6-829-014687



34 - 105 ft.
(10.4 - 32.0 m)



29 - 51 ft.
(8.8 - 15.5 m)



0 lbs.
(0 kg)



100%



360°



85% Domestic (Pounds)

(Feet)	RETRACTED 29' LENGTH		EXTENDED 51' LENGTH	
	0° OFFSET	30° OFFSET	0° OFFSET	30° OFFSET
30	9,000			
35	8,600		*5,060	
40	8,250	*5,000	4,900	
45	7,500	4,800	4,700	
50	6,850	4,600	4,400	
55	6,250	4,400	4,000	*2,800
60	5,600	4,350	3,800	2,700
65	5,000	4,300	3,700	2,600
70	4,450	4,250	3,500	2,500
75	4,000	4,190	3,400	2,400
80	3,470	3,470	3,300	2,350
85	2,850	2,850	3,100	2,300
90	2,310	2,310	2,900	2,250
95	1,830	1,830	2,410	2,200
100	1,410	1,410	1,930	1,930
105	1,020	1,020	1,500	1,500
110			1,110	1,110

*This capacity is based upon maximum boom angle.

A6-829-014688

THIS CHART IS ONLY A GUIDE AND SHOULD NOT BE USED TO OPERATE THE CRANE. The individual crane's load chart, operating instructions and other instructional plates must be read and understood prior to operating the crane.



34 - 105 ft.
(10.4 - 32.0 m)

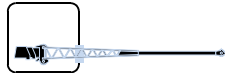

29 - 51 ft.
(8.8 - 15.5 m)



3,900 lbs.
(1769 kg)



50%
(13' 10") Outrigger Spread



360°



SAEJ1289 APR81

(Feet)	RETRACTED 29' LENGTH		EXTENDED 51' LENGTH	
	0° OFFSET	30° OFFSET	0° OFFSET	30° OFFSET
30	9,000			
35	8,600		*5,060	
40	8,250	*5,000	4,900	
45	7,430	4,800	4,700	
50	6,010	4,600	4,400	
55	4,760	4,400	4,000	*2,800
60	3,740	3,740	3,800	2,700
65	2,900	2,900	3,700	2,600
70	2,190	2,190	3,150	2,500
75	1,590	1,590	2,450	2,400
80	1,070	1,070	1,850	1,850
85			1,320	1,320

*This capacity is based upon maximum boom angle.

A6-829-014689



34 - 105 ft.
(10.4 - 32.0 m)



29 - 51 ft.
(8.8 - 15.5 m)



0 lbs.
(0 kg)



50%
(13' 10") Outrigger Spread



360°



SAEJ1289 APR81

(Feet)	RETRACTED 29' LENGTH		EXTENDED 51' LENGTH	
	0° OFFSET	30° OFFSET	0° OFFSET	30° OFFSET
30	9,000			
35	8,600		*5,060	
40	7,390	*5,000	4,900	
45	5,880	4,800	4,700	
50	4,660	4,600	4,400	
55	3,560	3,560	4,000	*2,800
60	2,660	2,660	3,610	2,700
65	1,910	1,910	2,920	2,600
70	1,280	1,280	2,240	2,240
75			1,610	1,610
80			1,060	1,060

*This capacity is based upon maximum boom angle.

A6-829-014690

THIS CHART IS ONLY A GUIDE AND SHOULD NOT BE USED TO OPERATE THE CRANE. The individual crane's load chart, operating instructions and other instructional plates must be read and understood prior to operating the crane.



NOTES:

Rated Lifting Capacities

IMPORTANT NOTES:

WARNING: THIS CHART IS ONLY A GUIDE.
The notes below are for illustration only and should not be relied upon to operate the crane.
The individual crane's load chart, operating instructions and other instruction plates must be read and understood prior to operating the crane.

1. All rated loads have been tested to and meet minimum requirements of SAEJ1063 NOV93 - Cantilevered Boom Crane Structures - Method of Test, and do not exceed 85% of the tipping load on outriggers fully extended and SAEJ1289 APR81 - Mobile Crane Stability Ratings on outriggers 50% and 0% extended (fully retracted) as determined by SAEJ765 OCT90 - Crane Stability Test Code.

2. Capacities given do not include the weight of hook blocks, slings, auxiliary lifting equipment and load handling devices. Their weights MUST be added to the load to be lifted. When more than minimum required reeving is used, the additional rope weight shall be considered part of the load.





































3. Capacities appearing above the bold line are based on structural strength and tipping should not be relied upon as a capacity limitation.

4. All capacities are for crane on firm, level surface. It may be necessary to have structural supports under the outrigger floats to spread the load to a larger bearing surface.

5. When either boom length or radius or both are between values listed, the smallest load shown at either the next larger radius or boom length shall be used.

6. For outrigger operation, ALL outriggers shall be properly extended with tires raised free of ground before raising the boom or lifting loads.

Symbols Glossary

	Frame		Steering
	Outriggers		Transmission
	Outrigger Controls		Axles
	Engine		Brakes
	Fuel Tank Capacity		Tires
	Electrical System		Suspension
	Drive		360° Rotation
	Lights		Boom Elevation
	Cab		Swing
	Boom		Counterweight
	Fixed Swingaway		Oil
	Tele-Swingaway		Hydraulic System
	Jib		Hoist
	Boom Nose		Radius
	Boom Extension		Boom Length
	Speed		Hookblock
	Grade		Gear
	Lattice Extension		Luffing Jib

TMS640



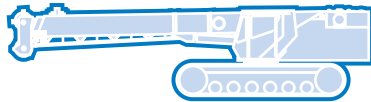
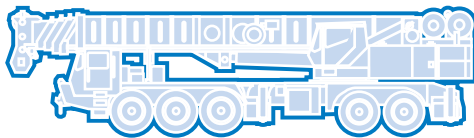
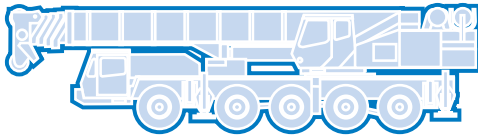
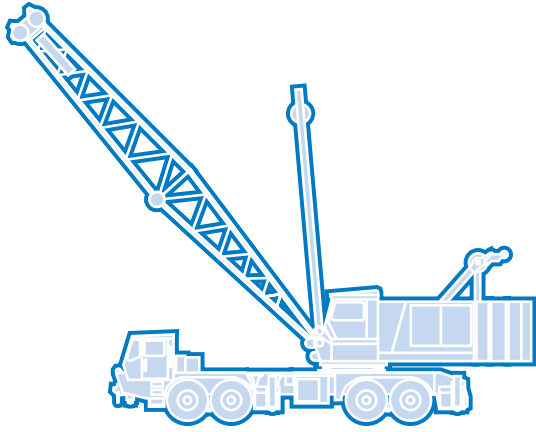

Grove Worldwide – World Headquarters
Grove North America
 1565 Buchanan Trail East
 P.O. Box 21
 Shady Grove, Pennsylvania 17256, U.S.A.
 Tel: [Int + 1] (717) 597-8121
 Fax: [Int + 1] (717) 597-4062
 Western Hemisphere, Asia/Pacific

Grove Europe Limited*
 Sunderland SR4 6TT, England
 Tel: [Int + 44] 191 565-6281
 Fax: [Int + 44] 191 564-0442
 Europe, Africa, Middle East

Grove Europe Limited*
 P.O. Box No. 268
 4A Kimber Road
 Abingdon, Oxfordshire, OX141SG
 Tel: [Int + 44] 1235 55-3184
 Fax: [Int + 44] 1235 55-3218

Deutsche Grove GmbH
Sales and Service
 Helmholtzstrasse 12, Postfach 5026
 D-40750 Langenfeld, Germany
 Tel: [Int + 49] (2173) 8909-0
 Fax: [Int + 49] (2173) 8909-30

Wilhelmshaven Works
 Industriegelände West, Postfach 1853
 D-26358 Wilhelmshaven, Germany
 Tel: [Int + 49] (4421) 294-0
 Fax: [Int + 49] (4421) 294-301

Grove France S.A.
 16, chaussée Jules-César, 95520 OSNY
 B.P. 203, 95523 CERGY PONTOISE CEDEX
 France
 Tel: [Int + 33] (1) 30313150
 Int: [Int + 33] (1) 30386085

*Grove Europe Limited, Registered in England,
 Number 1845128, Registered office, Crown Works,
 Pallion, Sunderland, Tyne & Wear, England SR4 6TT

Grove Asia/Pacific - Regional Office
 171 Chin Swee Road
 #06-01 San Centre
 Singapore 0316
 Tel: [Int + 65] 536-6112
 Fax: [Int + 65] 536-6119
 Asia/Pacific, Near East

Grove China - Representative Office
 Beijing Hotel Room 6074
 No. 33 East Chang An Avenue
 Beijing, 100004, China
 Tel: [Int + 86] (10) 513-7766
 Fax: [Int + 86] (10) 513-7307

Grove Product Support
 Western Hemisphere, Asia/Pacific
 1086 Wayne Avenue
 Chambersburg, Pennsylvania USA
 Tel: [Int + 1] (717) 263-5100
 Fax: [Int + 1] (717) 267-0404

Europe, Africa, Middle East
 Sunderland SR4 6TT, England
 Tel: [Int + 44] 191 565-6281
 Parts Fax: [Int + 44] 191 510-9242
 Service Fax: [Int + 44] 191 510-9560

Constant improvement and engineering progress make it necessary that we reserve the right to make specification, equipment, and price changes without notice. Illustrations shown may include optional equipment and accessories and may not include all standard equipment.

Distributed By:

Form No.: TMS 640 Part No.: 3-1049 1296-5M Printed in U.S.A.

Bigge Crane and Rigging Co.

10700 Bigge Avenue
 San Leandro, CA 94577
 Phone: (888) 337-BIGGE or (510) 638-8100
 Fax: (510) 639-4053
 Email: info@bigge.com
 Web site: www.bigge.com

