

## **TEREX CD SERIES**

rough terrain cranes  
specifications

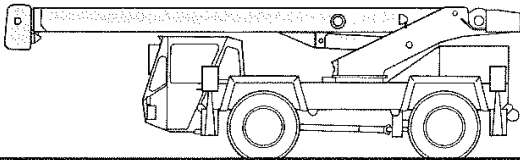

### **STANDARD BOOM EQUIPMENT**

#### **BOOM**

22 to 52 ft. (6.78-15.85 m), three section full power boom. Telescoping is mechanically synchronized with single lever control. The synchronization system consists of a single hydraulic cylinder and leaf chains to extend the outer section. Boom is high strength four plate design, welded inside and out, with anti-friction slide pads. A single boom hoist cylinder provides for boom elevation of 0 to 75 degrees. All cylinders are

equipped with integral hold valves. Maximum tip height is 58 ft. (17.7 m).

#### **BOOM HEAD**

Welded to outer section of boom. Three metallic load sheaves and two idler sheaves mounted on heavy duty, anti-friction bearings. Quick reeving boom head. Provisions made for side-stow jib mounting.

### **OPTIONAL BOOM EQUIPMENT**

#### **MAIN BOOM**

22-36 ft. (6.78-10.97 m), two section full power boom telescopes with single lever control for telescope cylinder. Boom is high strength four plate design, welded inside and out, with anti-friction slide pads. A single boom hoist cylinder provides for boom elevation of 0 to 75 degrees. All cylinders are equipped with integral hold valves. Maximum tip height is 42 ft. (12.8 m).

#### **HOOK BLOCK**

Two or three metallic sheaves on anti-friction bearing with hook and hook latch. Quick reeving design does not require removal of wedge and socket from rope.

#### **HOOK & BALL**

7 ton (6.3 mt) top swivel ball with hook and hook latch.

#### **JIB**

15 ft. (4.57 m) side stow swing-away jib. Single metallic sheave mounted on anti-friction bearing. Jib is offsettable at 0°, 15° or 30°. Maximum tip height is 71 ft. (21.64 m).

# TEREX CD 115

rough terrain crane  
15 ton capacity

## range diagram & lifting capacities

**REDUCTION IN MAIN BOOM CAPACITY**

All Jibs in Stowed Position	0 Lbs.
15' Jib Erected	500 Lbs.

**HOOK BLOCK WEIGHTS**

Hook & Ball	121 Lbs.
Hook Block (2 Sheave)	325 Lbs.
Hook Block (3 Sheave)	350 Lbs.

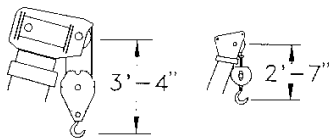

Dimensions are for largest factory furnished hook block and hook and ball with anti-two block activated.

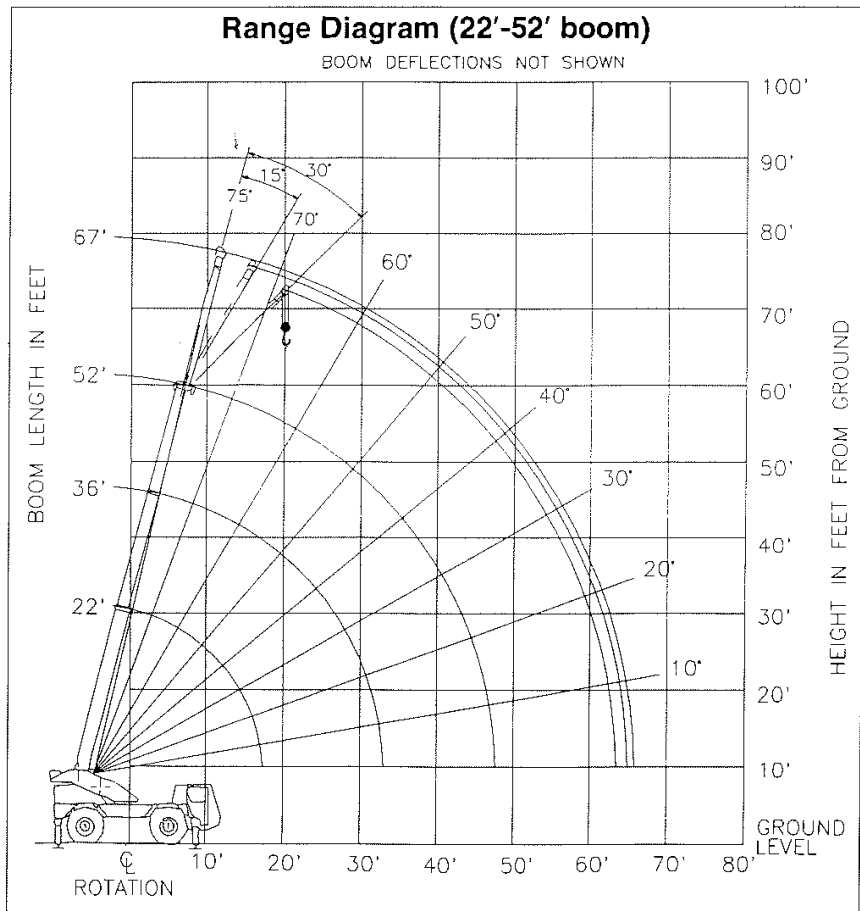

**CD 115 TURNING CIRCLES**

	2-Wheel Steer	4-Wheel Steer
<b>Turning Radius</b>	22' 4"	14' 10.5"
<b>Curb Clearance Circle</b> (Over 15.00 x 22.5 Tires)	45' 11.5"	31' 0.5"
<b>Machine Clearance Circle</b> (Over Boom Head)	49' 0"	34' 2"
(Over Stowed Jib)	50' 7"	35' 9"

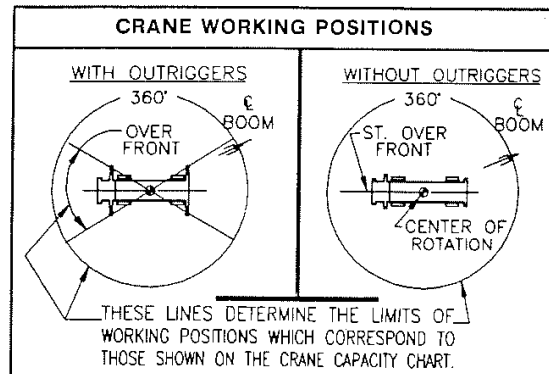

# Lifting Capacities — Pounds (22'-52' boom)

**MODEL CD115**

**CAUTION:** Do not use this specification sheet as a load rating chart. The format of data is not consistent with the machine chart and may be subject to change.

COUNTERWEIGHT	5000 LB.	STABILITY PCT.	
BOOM LENGTH	22-52 FT.	ON OUTRIGGERS	85%
OUTRIGGER SPREAD	12 FT. 4.9 IN.	ON TIRES	75%
		PCSA CLASS	6-33

**ON OUTRIGGERS**

LOAD RADIUS (FT)	BOOM LENGTH 22 FT			BOOM LENGTH 36 FT			BOOM LENGTH 52 FT			LOAD RADIUS (FT)
	LOADED BOOM ANGLE (DEG)	OVER FRONT (LB)	360° (LB)	LOADED BOOM ANGLE (DEG)	OVER FRONT (LB)	360° (LB)	LOADED BOOM ANGLE (DEG)	OVER FRONT (LB)	360° (LB)	
6	64.5	30,000*	30,000*							6
8	58.4	28,400*	28,400*	71.3	26,500*	26,500*				8
10	51.9	23,100*	22,400*	67.9	23,200*	22,900*				10
12	44.6	18,800*	18,300*	64.4	19,200*	18,700*				12
15	31.0	14,500*	14,100*	58.8	14,900*	14,500*	69.0	15,000*	14,700*	15
18	**			52.9	12,000*	11,700*	65.4	12,100*	11,800*	18
20				48.7	10,500*	10,200*	62.9	10,700*	10,400*	20
25				36.4	7,900*	7,400*	56.4	8,000*	7,600*	25
30				17.5	6,100*	5,400*	49.4	6,300*	5,600*	30
35				**			41.4	5,000	4,200	35
40							31.8	3,900	3,300	40
45							17.9	3,100	2,600	45
50							**			50

**\*\* MAXIMUM CAPACITY AT 0 DEGREE BOOM ANGLE**

BOOM LENGTH 30 FT			BOOM LENGTH 39 FT			BOOM LENGTH 50 FT		
LOAD RADIUS (FT)	OVER FRONT (LB)	360° (LB)	LOAD RADIUS (FT)	OVER FRONT (LB)	360° (LB)	LOAD RADIUS (FT)	OVER FRONT (LB)	360° (LB)
17.5	8,500*	8,500*	31.3	4,500*	4,500*	47.1	2500*	2,300

**ON TIRES**

RADIUS (FT)	MAX BOOM LENGTH (FT)	15:00 X 22.5-16PR				RADIUS (FT)
		STATIONARY		PICK & CARRY		
		360°	STRAIGHT OVER FRONT	CREEP	2.5 MPH	
6	22	15,500*				6
8	22	13,300*				8
10	22	10,300*	15,500*	12,300*	10,100*	10
12	36	8,300*	13,300*	10,500*	8,600*	12
15	50	6,300*	9,900	8,500*	6,900*	15
18	52	4,900	7,300	7,000*	5,600*	18
20	52	4,000	6,200	6,200	5,000*	20
25	52	2,700	4,300	4,300	3,800*	25
30	52	2,000	3,100	3,100	2,900*	30
35	52	1,400	2,400	2,400	2,300*	35
40	52	1,000	1,800	1,800	1,800	40
45	52	700	1,400	1,400	1,400	45

Notes For On Tires Capacities:

- A. For Pick and Carry Operations, boom must be centered over the front of the machine.
- B. The load should be restrained from swinging.
- C. Creep Speed is crane movement of less than 200 ft. (61 m) in a 30 minute period and not exceeding 1.0 mph (1.6 km/h).
- D. Refer to General Notes for additional information.
- E. Without outriggers, never maneuver the boom beyond listed load radii for applicable tires used to ensure stability.

**RECOMMENDED TIRE PRESSURE**

TIRE SIZE	STATIONARY	CREEP	2 1/2 MPH	TRAVEL
15:00 X 22.5-16 PR	110 PSI	110 PSI	100 PSI	90 PSI

**SIDE STOW JIB ON OUTRIGGERS**

LOADED BOOM ANGLE (DEG)	15 FT OFFSETABLE JIB						LOADED BOOM ANGLE (DEG)
	0° OFFSET		15° OFFSET		30° OFFSET		
	LOAD RADIUS (REF) (FT)	360° (LB)	LOAD RADIUS (REF) (FT)	360° (LB)	LOAD RADIUS (REF) (FT)	360° (LB)	
75	16'-2"	5,500*	18'-4"	4,100*	21'-1"	3,400*	75
73	18'-9"	5,500*	21'-1"	4,000*	23'-8"	3,400*	73
71	21'-2"	5,400*	23'-9"	3,800*	26'-1"	3,200*	71
68	24'-8"	5,400*	27'-5"	3,600*	29'-7"	3,100*	68
65	27'-11"	5,000*	30'-10"	3,500*	32'-10"	3,000*	65
62	31'-1"	4,700*	34'-0"	3,300*	35'-11"	2,900*	62
59	34'-1"	4,400*	37'-0"	3,200*	38'-9"	2,800*	59
55	37'-10"	4,000	40'-4"	3,100*	41'-10"	2,700*	55
51	41'-5"	3,500	43'-5"	3,100*	44'-10"	2,600*	51
47	44'-6"	3,000	46'-5"	2,900*	47'-10"	2,600*	47
43	47'-5"	2,700	49'-1"	2,600	50'-5"	2,500	43
38	51'-0"	2,300	52'-3"	2,200	53'-5"	2,200	38
32	54'-4"	2,000	56'-0"	1,900	56'-4"	1,900	32
25	57'-8"	1,800	59'-0"	1,700			25
17	61'-1"	1,500	61'-3"	1,500			17
0	63'-3"	1,400					0

Notes For Jib Capacities:

- F. For all boom lengths less than the maximum with a jib erected, the rated loads are determined by boom angle only in the appropriate column.
- G. For boom angles not shown, use the capacity of the next lower boom angle.
- H. Listed radii are for fully extended main boom only.

**MAXIMUM PERMISSIBLE HOIST LINE LOAD**

LINE PARTS	1	2	3	4	5	6
6X19 OR 6X37 ROPE	6,000	12,000	18,000	24,000	30,000	36,000
ROTATION RESISTANT ROPE	5,800	11,600	17,400	23,200	29,000	34,800
BOOM HEAD	1	1-D	1-2	1-2-D	1-2-3	1-2-3-D
HOOK BLOCK	D	1	1-D	1-2	1-2-D	1-2-3
WIRE ROPE: 1/2" ROTATION RESISTANT COMPACTED STRAND, 18X19 OR 19 X 19 MINIMUM BREAKING STRENGTH - 14.6 TONS						
1/2" 6X19 OR 6X37 IWRC IPS PREFORMED RIGHT REGULAR LAY MINIMUM BREAKING STRENGTH - 11.5 TONS						

## GENERAL NOTES

### GENERAL

1. Rated loads as shown on Lift Charts pertain to this machine as originally manufactured and equipped. Modifications to the machine or use of optional equipment other than that specified can result in a reduction of capacity.
2. Construction equipment can be hazardous if improperly operated or maintained. Operation and maintenance of this machine shall be in compliance with the information in the Operator's, Parts and Safety Manuals supplied with this machine. If these manuals are missing, order replacements from the manufacturer through your distributor.
3. These warnings do not constitute all of the operating conditions for the crane. The operator and job site supervision must read the OPERATOR'S MANUAL, CIMA SAFETY MANUAL, APPLICABLE OSHA REGULATIONS, AND SOCIETY OF MECHANICAL ENGINEERS (ASME) SAFETY STANDARDS FOR CRANES.
4. This crane and its load ratings are in accordance with POWER CRANE & SHOVEL ASSOCIATION, STANDARD NO. 4, SAE CRANE LOAD STABILITY TEST CODE J765A, SAE METHOD OF TEST FOR CRANE STRUCTURE J1063, AND APPLICABLE SAFETY CODE FOR CRANES, DERRICKS AND HOISTS, ASME/ANSI B30.5.

### DEFINITIONS

1. **LOAD RADIUS** – The horizontal distance from the axis of rotation before loading to the center of the vertical hoist line or tackle with a load applied.
2. **LOADED BOOM ANGLE** – It is the angle between the boom base section and the horizontal, after lifting the rated load at the rated radius. The boom angle before loading should be greater to account for deflections. The loaded boom angle combined with boom length give only an approximation of the operating radius.
3. **WORKING AREA** – Areas measured in a circular arc about the centerline of rotation as shown in the diagram.
4. **FREELY SUSPENDED LOAD** – Load hanging free with no direct external force applied except by the hoist rope.
5. **SIDE LOAD** – Horizontal force applied to the lifted load either on the ground or in the air.
6. **NO LOAD STABILITY LIMIT** – The stability limit radius shown on the range diagrams is the radius beyond which it is not permitted to position the boom, when the boom angle is less than the minimum shown on the applicable load chart, because the machine can overturn without any load.

### SET-UP

1. Crane load ratings are based on the crane being leveled and standing on a firm, uniform supporting surface.
2. Crane load ratings on outriggers are based on all outrigger beams being fully extended or in the case of partial extension ratings mechanically pinned in the appropriate position, and the tires free of the supporting surface.
3. Crane load ratings on tires depend on appropriate inflation pressure and the tire conditions. Caution must be exercised when increasing air pressures in tires. Consult Operator's Manual for precautions.
4. Use of jibs, lattice-type boom extensions, or fourth section pullouts extended is not permitted for pick and carry operations.
5. Consult appropriate section of the Operator's and Service Manual for more exact description of hoist line reeving.
6. The use of more parts of line than required by the load may result in having insufficient rope to allow the hook block to reach the ground.
7. Properly maintained wire rope is essential for safe crane operation. Consult Operator's Manual for proper maintenance and inspection requirements.

8. When spin-resistant wire rope is used, the allowable rope loading shall be the breaking strength divided by five (5), unless otherwise specified by the wire rope manufacturer.

### OPERATION:

1. **CRANE LOAD RATINGS MUST NOT BE EXCEEDED. DO NOT ATTEMPT TO TIP THE CRANE TO DETERMINE ALLOWABLE LOADS.**
2. When either radius or boom length, or both, are between listed values, the smaller of the two listed load ratings shall be used.
3. Do not operate at longer radii than those listed on the applicable load rating chart (cross hatched areas shown on range diagrams).
4. The boom angles shown on the Capacity Chart give an approximation of the operating radius for a specified boom length. The boom angle, before loading, should be greater to account for boom deflection. It may be necessary to retract the boom if maximum boom angle is insufficient to maintain rated radius.
5. Power telescoping boom sections must be extended equally.
6. Rated loads include the weight of hook block, slings, and auxiliary lifting devices. Their weights shall be subtracted from the listed rated load to obtain the net load that can be lifted.  
When lifting over the jib the weight of any hook block, slings, and auxiliary lifting devices at the boom head must be added to the load.  
When jibs are erected but unused add two (2) times the weight of any hook block, slings, and auxiliary lifting devices at the jib head to the load.
7. Rated loads do not exceed 85% on outriggers or 75% on tires, of the tipping load as determined by SAE Crane Stability Test Code J765a. Rated loads for partially extended outriggers are determined from the formula,  $\text{Rated Load} = (\text{Tipping Load} - 0.1 \times \text{Tip Reaction}) / 1.25$ . Structural strength ratings in chart are indicated with an asterisk (\*).
8. Rated loads are based on freely suspended loads. No attempt shall be made to drag a load horizontally on the ground in any direction.
9. The user shall operate at reduced ratings to allow for adverse job conditions, such as: Soft or uneven ground, out of level conditions, high winds, side loads, pendulum action, jerking or sudden stopping of loads, hazardous conditions, experience of personnel, two machine lifts, traveling with loads, electric wires, etc., (side pull on boom or jib is hazardous). Derating of the cranes lifting capacity is required when wind speed exceeds 20 MPH. the center of the lifted load must never be allowed to move more than 3" feet off the center line of the base boom section due to the effects of wind, inertia, or any combination of the two.  
"Use 2 feet off the center line of the base boom for a two section boom, 3 feet for a three section boom, or 4 feet for a four section boom."
10. The maximum load which can be telescoped is not definable, because of variations in loadings and crane maintenance, but it is permissible to attempt retraction and extension if load ratings are not exceeded.
11. Load ratings are dependent upon the crane being maintained according to manufacturer's specifications.
12. It is recommended that load handling devices, including hooks, and hook blocks, be kept away from boom had at all times.
13. **FOR TRUCK ONLY:** 360° capacities apply only to machines equipped with a front outrigger jack and all five (5) outrigger jacks properly set. If the front (5th) outrigger jack is not properly set, the work area is restricted to the over side and over rear areas as shown on the Crane Working Positions diagram. Use the 360° load ratings in the overside work.



WE RESERVE THE RIGHT TO AMEND THESE SPECIFICATIONS AT ANY TIME WITHOUT NOTICE. THE ONLY WARRANTY APPLICABLE IS OUR STANDARD WRITTEN WARRANTY APPLICABLE TO THE PARTICULAR PRODUCT AND SALE. WE MAKE NO OTHER WARRANTY, EXPRESSED OR IMPLIED.

 **TEREX CRANES**  
Waverly, Iowa

TEREX CRANES, INC.  
106 12th Street S.E. • Waverly, IA 50677-9466 USA  
(319) 352-3920 • FAX: (319) 352-5727



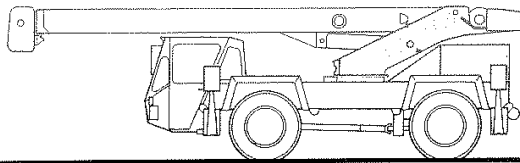

## STANDARD UPPERSTRUCTURE EQUIPMENT

### UPPERSTRUCTURE FRAME

All welded one-piece structure fabricated with high tensile strength alloy steel. Counterweight is bolted to frame.

### TURNTABLE CONNECTION

Swing bearing is a single row, ball type, with external teeth. The swing bearing is bolted to the revolving upperstructure and to the carrier chassis.

### SWING

A geroler type hydraulic motor drives a self locking worm gear reduction for precise and smooth swing function. Maximum swing speed (no load) is 3.0 rpm.

### OPTIONAL EQUIPMENT

Strobe Light • Rotating Beacon • Work Lights

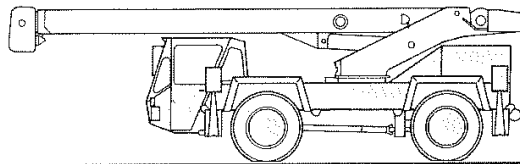

## STANDARD CARRIER EQUIPMENT

### OPERATOR'S CAB

Environmental cab with all steel construction, tinted safety glass throughout, and rubber floor matting. The cab has a hinged door on the left side, framed sliding window on the right side, rear, and in the door, and a tinted skylight to provide optimized visibility of the load. Entry is from ground level. Acoustical foam padding insulates against sound and weather. The deluxe six-way adjustable operator's seat includes head and arm rests.

### RATED CAPACITY INDICATOR

Rated Capacity Indicator with visual and audible warning system and automatic function disconnects. Pictographic display includes: boom radius, boom angle, boom length, allowable load, actual load, and percentage of allowable load registered by bar graph. Operator settable alarms provided for swing angle, boom length, boom angle, tip height, and work area exclusion zone. Anti-two block system includes audio/visual warning and automatic function disconnects.

### CONTROLS

All control levers and pedals are positioned for efficient operation. Hand operated control levers include swing, boom telescope, boom hoist, winch, outrigger directional control, shift, vernier adjustable hand throttle, steering mode, and parking brake. Switches include ignition, engine start, and outrigger controls. Foot control pedals include service brakes and accelerator.

### INSTRUMENTATION AND ACCESSORIES

In-cab gauges include bubble level, engine oil pressure, fuel, engine coolant temperature, voltmeter, transmission temperature, transmission charge pump pressure. Indicators include hoist drum rotation indicator, and Rated Capacity Indicator. Accessories include fire extinguisher; light package including headlights, tail light, brake lights, directional signals, four-way hazard flashers, dome & dash lights, and back-up lights with audible back-up alarm; windshield washer/wiper; skylight wiper; R.H. and L.H. rear view mirrors; and seat belt.

### HYDRAULIC CONTROL VALVES

Valves are mounted in the carrier and are easily accessible. Valves are mechanically operated and include one four spool valve for swing, boom elevation, telescope, and outriggers and one single spool valve for winch. Quick disconnects are provided for quick connection of pressure check gauges.

### CARRIER CHASSIS

High strength chassis with four-wheel drive and four-wheel steer is built specifically for rough terrain service. Has a precision machined turntable mounting plate and integrally welded outrigger boxes. Decking has skid-resistant surfaces. Lockable tool box and battery box. Steps and handles for access are located at the front corners.

### AXLES AND SUSPENSION

Rear axle is a planetary drive/steer type with automatic oscillation lockouts that engage when the superstructure is swung 10° in either direction. Front axle is a planetary drive/steer type, rigid mounted to the frame for increased stability.

### WHEELS & TIRES

Disc type wheels with 15° drop center rim. 108 in (2.74 m) wheelbase.

### TIRES

Standard: 15.00 x 22.5-16PR

### SERVICE BRAKES

Hydraulically-assisted hydraulic split braking system has wet disc brakes to provide effortless slowdown and stop.

### PARKING BRAKE

Parking brake control mechanically actuates front axle service brakes.



## STANDARD CARRIER EQUIPMENT (continued)

### STEERING

Hydraulic four-wheel power steering for two-wheel, four-wheel, or crab steer is easily controlled by steering wheel. Turning radius to center of outside tire.

	(15 x 22.5 Tires)
Two-wheel:	22'4" (6.81 m)
Four-wheel:	14' 10.5" (4.53 m)

### TRANSMISSION

Full powershift transmission with torque converter has 4 speeds forward, 3 reverse. Automatic pulsating back-up alarm.

### FOLD-DOWN OUTRIGGERS

Fold-down outriggers have self-storing floats, each with an area of 220 in<sup>2</sup> (1417 cm<sup>2</sup>). Controls and sight leveling bubble are located in operator's cab.

### OPTIONAL EQUIPMENT

Carry decks with 66.5 sq. ft. (6.18 m<sup>2</sup>) surface area and a 20,000 lb. (9070 kg) capacity • Cold Weather Starting Aid • Pintle Hook • Immersion Heater • Front Mounted Winch - 10,000 lbs. (4535 kg) • Independent Rear Wheel Steer • Speedometer • Air Conditioner

## HYDRAULIC SYSTEM

### HYDRAULIC PUMPS

Two gear type pumps in tandem driven off the transmission. Combined system capacity is 37 gpm (140 lpm). Includes manual pump disconnect.

### Power Steering, Swing, Boom Hoist, Telescope, Outrigger and Winch Boost Pump

20 gpm (76 lpm) @ 2,750 psi (210 kg/cm<sup>2</sup>)

### Winch Pump

17 gpm (64 lpm) @ 2,650 psi (185 kg/cm<sup>2</sup>)

### FILTRATION

Full flow oil filtration system with bypass protection includes a removable 140 micron suction screen-type filter and 10 micron spin on return line filter.

### HYDRAULIC RESERVOIR

All steel, welded construction with internal baffle. Provides easy access to filters and is equipped with an external sight level gauge. The hydraulic tank is pressurized to aid in keeping out contaminants and in reducing potential pump cavitation. Capacity is 24 gallons (91 liters). System capacity is 43 gallons (163 liters).

### WINCH SPECIFICATIONS

Hydraulic winch with gear type motor and planetary reduction gearing. Equal speeds up and down. Winch is equipped with an integral automatic brake.

### PERFORMANCE

Max. line speed (no load)	
First Layer	177 fpm (54 m/min)
Fourth Layer	236 fpm (72 m/min)
Full Drum	275 fpm (84 m/min)

Max. line pull-first layer	7,460 lbs. (3384 kg)
Max. line pull-fourth layer	5,600 lbs. (2540 kg)
Max. line pull-full drum	4,800 lbs. (2177 kg)
Permissible line pull	6,350 lbs. (2880 kg)

### DRUM DIMENSIONS

8.5 in. (216 mm) drum diameter  
12.2 in. (311 mm) length  
14.6 in. (370 mm) flange dia.  
Cable: 0.50 in. x 275 ft.  
(12.7 mm x 84 m)

### DRUM CAPACITY

Max. Storage 439 ft. (134 m)  
Max. Usable 350 ft. (107 m)\*

\*Based on minimum flange height above top layer to comply with ANSI B30.5

### ENGINE PERFORMANCE

Gear	Drive	Maximum Speed		Maximum Tractive Effort		Gradeability @ Stall	
		Std.	Opt.	Std.	Opt.	Std.	Opt.
1	2 or 4 (4.8 km/h)	3.6 mph (4.2 km/h)	3.1 mph (7871 kg)	17,355 lbs. (8935 kg)	19,702 lbs.	73.1%	91.0%
2	2 or 4 (10.3 km/h)	7.7 mph (9.0 km/h)	6.7 mph (3601 kg)	7,941 lbs. (4069 kg)	9,016 lbs.	26.6%	31.1%
3	2 or 4 (24.7 km/h)	18.4 mph (22.0 km/h)	16.4 mph (1450 kg)	3,198 lbs. (1647 kg)	3,631 lbs.	9.3%	10.8%
4	2 or 4 (30.6 km/h)	23.0 mph (32.5 km/h)	24.2 mph (959 kg)	2,115 lbs. (1089 kg)	2,401 lbs.	5.4%	6.5%

All performance data is based on a gross vehicle weight of 27,255 lbs. (12,363 kg). Performance may vary due to engine performance. Gradeability data is theoretical and is limited by tire slip, stability, or engine pan design.

### ENGINE SPECIFICATIONS

Make and Model	Standard Cummins 4B3.9	Optional Caterpillar 3054 DIT
Type	4 cylinder	4 cylinder
Bore and Stroke	4.02 x 4.72 in. (101 x 120 mm)	3.94 x 5.0 in. (100 x 127 mm)
Displacement	239 cu. in. (3.9 l)	243 cu. in. (4.0 l)
Max. Gross Horsepower	80 hp (59.6 kw) @ 2800 rpm	109 hp (81.3kw) @ 2400 rpm
Max. Gross Torque	184 lbs.-ft. ( 249 N•m) @ 1200 rpm	280 lbs.-ft. (380 N•m) @ 1500 rpm
Aspiration	natural	turbocharged
Air Filter	dry type	dry type
Electrical System	24 volt	24 volt
Alternator	40 amp	55 amp
Battery	(2) 12V-800 CCA	(2) 12V-800 CCA
Fuel Capacity	44 gal. (163 l)	44 gal. (163 l)



### GENERAL DIMENSIONS

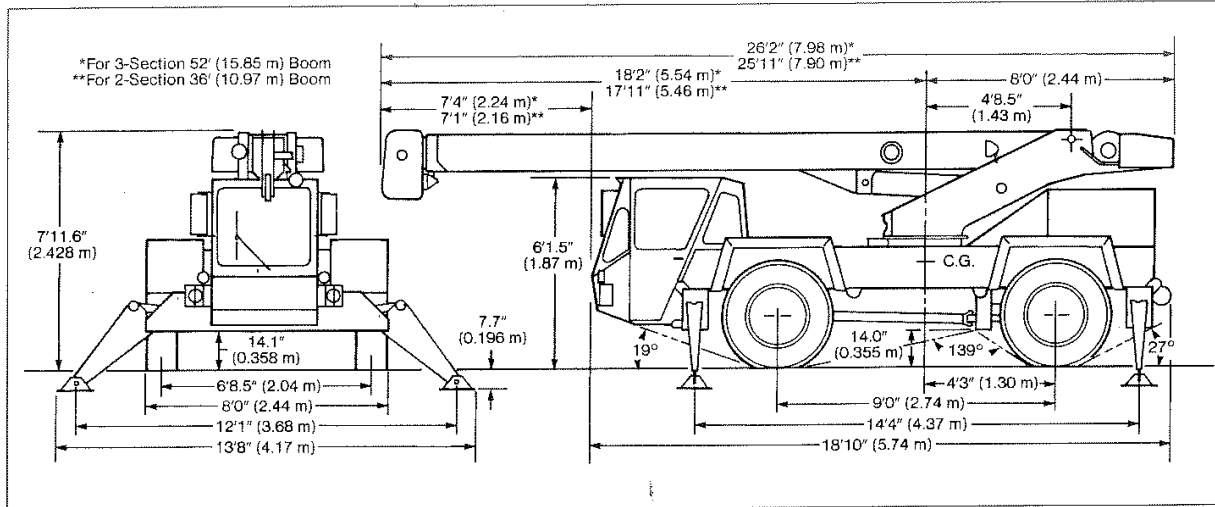

WEIGHTS & AXLE LOADS	Gross Weight lbs	UPPER FACING FRONT		Gross Weight Kg	UPPER FACING FRONT	
		Front	Rear		Front	Rear
Basic Crane with 52' (15.85 m ) Boom and 5,000 lbs. (2268 kg) Counterweight	27,320	11,968	15,352	12 392	5429	6963
15' (4.57m) Swing-on Jib (stowed)	+521	+948	-427	+236	+430	-194
Carry Decks	+1,184	+626	+558	+537	+284	+253
Pintle Hook (Rear)	+35	-12	+47	+16	-5	+21
25T (22.6 mt) 3-Sheave Hook Block	+350	+645	-295	+159	+293	-134
15T (13.6 mt) 2-Sheave Hook Block	+325	+599	-274	+147	+272	-125
7T (6.3 mt) Hook and Ball (In Tool Box)	+121	+71	+50	+55	+32	+23

Note: Weights are for factory supplied equipment and subject to 2% variation due to manufacturing tolerances.

WE RESERVE THE RIGHT TO AMEND THESE SPECIFICATIONS AT ANYTIME WITHOUT NOTICE. THE ONLY WARRANTY APPLICABLE IS OUR STANDARD WRITTEN WARRANTY APPLICABLE TO THE PARTICULAR PRODUCT AND SALE. WE MAKE NO OTHER WARRANTY, EXPRESSED OR IMPLIED.

**TEREX CRANES**  
Waverly, Iowa

106 12th Street S.E. • Waverly, IA 50677-9466 USA  
(319) 352-3920 • FAX: (319) 352-5727



# TEREX CD 115

rough terrain crane  
15 ton capacity

## range diagram & lifting capacities

**REDUCTION IN MAIN BOOM CAPACITY**

All Jibs in Stowed Position	0 Lbs.
15' Jib Erected	500 Lbs.

**HOOK BLOCK WEIGHTS**

Hook & Ball	121 Lbs.
Hook Block (2 Sheave)	325 Lbs.
Hook Block (3 Sheave)	350 Lbs.

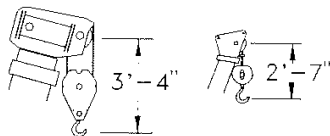

Dimensions are for largest factory furnished hook block and hook and ball with anti-two block activated.

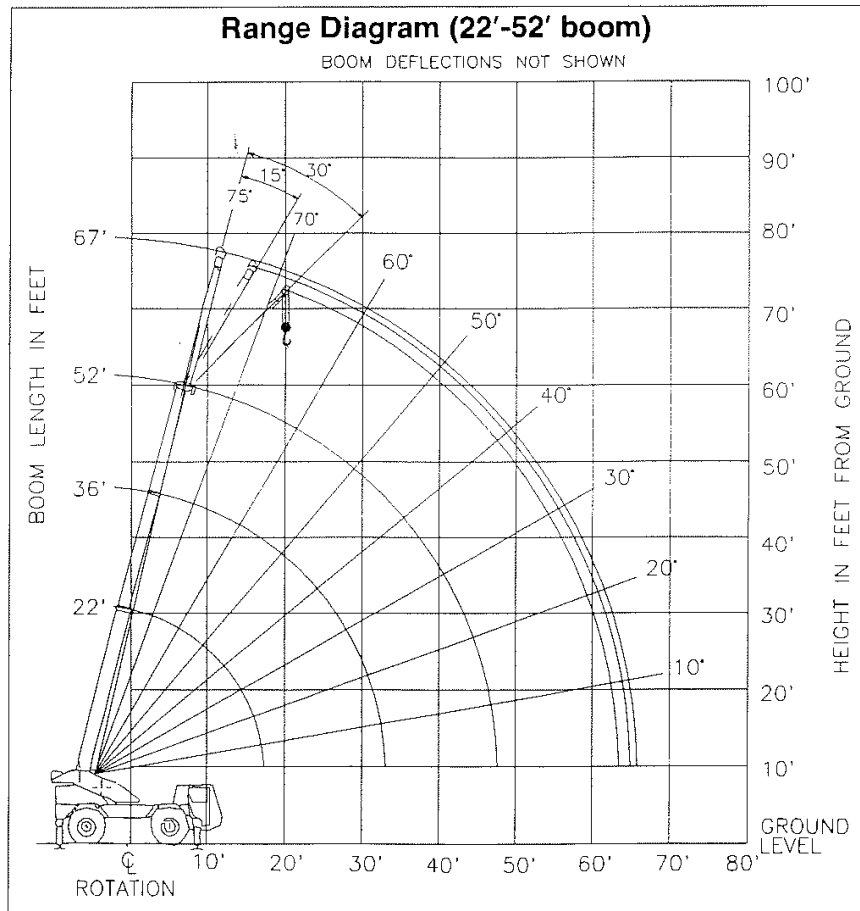

**CD 115 TURNING CIRCLES**

	2-Wheel Steer	4-Wheel Steer
<b>Turning Radius</b>	22' 4"	14' 10.5"
<b>Curb Clearance Circle</b> (Over 15.00 x 22.5 Tires)	45' 11.5"	31' 0.5"
<b>Machine Clearance Circle</b> (Over Boom Head)	49' 0"	34' 2"
(Over Stowed Jib)	50' 7"	35' 9"

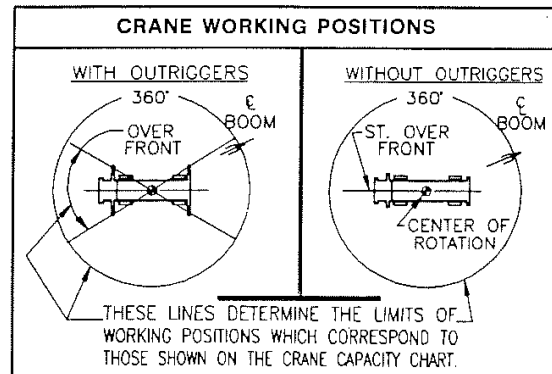

# Lifting Capacities — Pounds (22'-52' boom)

**MODEL CD115**

**CAUTION:** Do not use this specification sheet as a load rating chart. The format of data is not consistent with the machine chart and may be subject to change.

COUNTERWEIGHT	5000 LB.	STABILITY PCT.	
BOOM LENGTH	22-52 FT.	ON OUTRIGGERS	85%
OUTRIGGER SPREAD	12 FT. 4.9 IN.	ON TIRES	75%
		PCSA CLASS	6-33

**ON OUTRIGGERS**

LOAD RADIUS (FT)	BOOM LENGTH 22 FT			BOOM LENGTH 36 FT			BOOM LENGTH 52 FT			LOAD RADIUS (FT)
	LOADED BOOM ANGLE (DEG)	OVER FRONT (LB)	360° (LB)	LOADED BOOM ANGLE (DEG)	OVER FRONT (LB)	360° (LB)	LOADED BOOM ANGLE (DEG)	OVER FRONT (LB)	360° (LB)	
6	64.5	30,000*	30,000*							6
8	58.4	28,400*	28,400*	71.3	26,500*	26,500*				8
10	51.9	23,100*	22,400*	67.9	23,200*	22,900*				10
12	44.6	18,800*	18,300*	64.4	19,200*	18,700*				12
15	31.0	14,500*	14,100*	58.8	14,900*	14,500*	69.0	15,000*	14,700*	15
18	**			52.9	12,000*	11,700*	65.4	12,100*	11,800*	18
20				48.7	10,500*	10,200*	62.9	10,700*	10,400*	20
25				36.4	7,900*	7,400*	56.4	8,000*	7,600*	25
30				17.5	6,100*	5,400*	49.4	6,300*	5,600*	30
35				**			41.4	5,000*	4,200*	35
40							31.8	3,900*	3,300*	40
45							17.9	3,100*	2,600*	45
50							**			50

**\*\* MAXIMUM CAPACITY AT 0 DEGREE BOOM ANGLE**

BOOM LENGTH 30 FT			BOOM LENGTH 39 FT			BOOM LENGTH 50 FT		
LOAD RADIUS (FT)	OVER FRONT (LB)	360° (LB)	LOAD RADIUS (FT)	OVER FRONT (LB)	360° (LB)	LOAD RADIUS (FT)	OVER FRONT (LB)	360° (LB)
17.5	8,500*	8,500*	31.3	4,500*	4,500*	47.1	2,500*	2,300*

**ON TIRES**

RADIUS (FT)	MAX BOOM LENGTH (FT)	15:00 X 22.5-16PR				RADIUS (FT)
		STATIONARY		PICK & CARRY		
		360°	STRAIGHT OVER FRONT	CREEP	2.5 MPH	
6	22	15,500*				6
8	22	13,300*				8
10	22	10,300*	15,500*	12,300*	10,100*	10
12	36	8,300*	13,300*	10,500*	8,600*	12
15	50	6,300*	9,900*	8,500*	6,900*	15
18	52	4,900*	7,300*	7,000*	5,600*	18
20	52	4,000*	6,200*	6,200*	5,000*	20
25	52	2,700*	4,300*	4,300*	3,800*	25
30	52	2,000*	3,100*	3,100*	2,900*	30
35	52	1,400*	2,400*	2,400*	2,300*	35
40	52	1,000*	1,800*	1,800*	1,800*	40
45	52	700*	1,400*	1,400*	1,400*	45

Notes For On Tires Capacities:

- A. For Pick and Carry Operations, boom must be centered over the front of the machine.
- B. The load should be restrained from swinging.
- C. Creep Speed is crane movement of less than 200 ft. (61 m) in a 30 minute period and not exceeding 1.0 mph (1.6 km/h).
- D. Refer to General Notes for additional information.
- E. Without outriggers, never maneuver the boom beyond listed load radii for applicable tires used to ensure stability.

**RECOMMENDED TIRE PRESSURE**

TIRE SIZE	STATIONARY	CREEP	2 1/2 MPH	TRAVEL
15.00 X 22.5-16 PR	110 PSI	110 PSI	100 PSI	90 PSI

**SIDE STOW JIB ON OUTRIGGERS**

LOADED BOOM ANGLE (DEG)	15 FT OFFSETABLE JIB						LOADED BOOM ANGLE (DEG)
	0° OFFSET		15° OFFSET		30° OFFSET		
	LOAD RADIUS (REF) (FT)	360° (LB)	LOAD RADIUS (REF) (FT)	360° (LB)	LOAD RADIUS (REF) (FT)	360° (LB)	
75	16'-2"	5,500*	18'-4"	4,100*	21'-1"	3,400*	75
73	18'-9"	5,500*	21'-1"	4,000*	23'-8"	3,400*	73
71	21'-2"	5,400*	23'-9"	3,800*	25'-1"	3,200*	71
68	24'-8"	5,400*	27'-5"	3,600*	29'-7"	3,100*	68
65	27'-11"	5,000*	30'-10"	3,500*	32'-10"	3,000*	65
62	31'-1"	4,700*	34'-0"	3,300*	35'-11"	2,900*	62
59	34'-1"	4,400*	37'-0"	3,200*	38'-9"	2,800*	59
55	37'-10"	4,000*	40'-4"	3,100*	41'-10"	2,700*	55
51	41'-5"	3,500*	43'-5"	3,100*	44'-10"	2,600*	51
47	44'-6"	3,000*	46'-5"	2,900*	47'-10"	2,600*	47
43	47'-5"	2,700*	49'-1"	2,600*	50'-5"	2,500*	43
38	51'-0"	2,300*	52'-3"	2,200*	53'-5"	2,200*	38
32	54'-4"	2,000*	55'-0"	1,900*	56'-4"	1,900*	32
25	57'-8"	1,800*	59'-0"	1,700*			25
17	61'-1"	1,500*	61'-3"	1,500*			17
0	63'-3"	1,400*					0

Notes For Jib Capacities:

- F. For all boom lengths less than the maximum with a jib erected, the rated loads are determined by boom angle only in the appropriate column.
- G. For boom angles not shown, use the capacity of the next lower boom angle.
- H. Listed radii are for fully extended main boom only.

**MAXIMUM PERMISSIBLE HOIST LINE LOAD**

LINE PARTS	1	2	3	4	5	6
6X19 OR 6X37 ROPE	6,000	12,000	18,000	24,000	30,000	36,000
ROTATION RESISTANT ROPE	5,800	11,600	17,400	23,200	29,000	34,800
BOOM HEAD	1	1-D	1-2	1-2-D	1-2-3	1-2-3-D
HOOK BLOCK	D	1	1-D	1-2	1-2-D	1-2-3
WIRE ROPE: 1/2" ROTATION RESISTANT COMPACTED STRAND, 18X19 OR 19 X 19 MINIMUM BREAKING STRENGTH – 14.6 TONS 1/2" 6X19 OR 6X37 IWRC IPS PREFORMED RIGHT REGULAR LAY MINIMUM BREAKING STRENGTH – 11.5 TONS						

## GENERAL NOTES

### GENERAL

1. Rated loads as shown on Lift Charts pertain to this machine as originally manufactured and equipped. Modifications to the machine or use of optional equipment other than that specified can result in a reduction of capacity.
2. Construction equipment can be hazardous if improperly operated or maintained. Operation and maintenance of this machine shall be in compliance with the information in the Operator's, Parts and Safety Manuals supplied with this machine. If these manuals are missing, order replacements from the manufacturer through your distributor.
3. These warnings do not constitute all of the operating conditions for the crane. The operator and job site supervision must read the OPERATORS MANUAL, CIMA SAFETY MANUAL, APPLICABLE OSHA REGULATIONS, AND SOCIETY OF MECHANICAL ENGINEERS (ASME) SAFETY STANDARDS FOR CRANES.
4. This crane and its load ratings are in accordance with POWER CRANE & SHOVEL ASSOCIATION, STANDARD NO. 4, SAE CRANE LOAD STABILITY TEST CODE J765A, SAE METHOD OF TEST FOR CRANE STRUCTURE J1063, AND APPLICABLE SAFETY CODE FOR CRANES, DERRICKS AND HOISTS, ASME/ANSI B30.5.

### DEFINITIONS

1. **LOAD RADIUS** – The horizontal distance from the axis of rotation before loading to the center of the vertical hoist line or tackle with a load applied.
2. **LOADED BOOM ANGLE** – It is the angle between the boom base section and the horizontal, after lifting the rated load at the rated radius. The boom angle before loading should be greater to account for deflections. The loaded boom angle combined with boom length give only an approximation of the operating radius.
3. **WORKING AREA** – Areas measured in a circular arc about the centerline of rotation as shown in the diagram.
4. **FREELY SUSPENDED LOAD** – Load hanging free with no direct external force applied except by the hoist rope.
5. **SIDE LOAD** – Horizontal force applied to the lifted load either on the ground or in the air.
6. **NO LOAD STABILITY LIMIT** – The stability limit radius shown on the range diagrams is the radius beyond which it is not permitted to position the boom, when the boom angle is less than the minimum shown on the applicable load chart, because the machine can overturn without any load.

### SET-UP

1. Crane load ratings are based on the crane being leveled and standing on a firm, uniform supporting surface.
2. Crane load ratings on outriggers are based on all outrigger beams being fully extended or in the case of partial extension ratings mechanically pinned in the appropriate position, and the tires free of the supporting surface.
3. Crane load ratings on tires depend on appropriate inflation pressure and the tire conditions. Caution must be exercised when increasing air pressures in tires. Consult Operator's Manual for precautions.
4. Use of jibs, lattice-type boom extensions, or fourth section pullouts extended is not permitted for pick and carry operations.
5. Consult appropriate section of the Operator's and Service Manual for more exact description of hoist line reeving.
6. The use of more parts of line than required by the load may result in having insufficient rope to allow the hook block to reach the ground.
7. Properly maintained wire rope is essential for safe crane operation. Consult Operator's Manual for proper maintenance and inspection requirements.

8. When spin-resistant wire rope is used, the allowable rope loading shall be the breaking strength divided by five (5), unless otherwise specified by the wire rope manufacturer.

### OPERATION:

1. **CRANE LOAD RATINGS MUST NOT BE EXCEEDED. DO NOT ATTEMPT TO TIP THE CRANE TO DETERMINE ALLOWABLE LOADS.**
2. When either radius or boom length, or both, are between listed values, the smaller of the two listed load ratings shall be used.
3. Do not operate at longer radii than those listed on the applicable load rating chart (cross hatched areas shown on range diagrams).
4. The boom angles shown on the Capacity Chart give an approximation of the operating radius for a specified boom length. The boom angle, before loading, should be greater to account for boom deflection. It may be necessary to retract the boom if maximum boom angle is insufficient to maintain rated radius.
5. Power telescoping boom sections must be extended equally.
6. Rated loads include the weight of hook block, slings, and auxiliary lifting devices. Their weights shall be subtracted from the listed rated load to obtain the net load that can be lifted.

When lifting over the jib the weight of any hook block, slings, and auxiliary lifting devices at the boom head must be added to the load.

When jibs are erected but unused add two (2) times the weight of any hook block, slings, and auxiliary lifting devices at the jib head to the load.

7. Rated loads do not exceed 85% on outriggers or 75% on tires, of the tipping load as determined by SAE Crane Stability Test Code J765A. Rated loads for partially extended outriggers are determined from the formula,  $\text{Rated Load} = (\text{Tipping Load} - 0.1 \times \text{Tip Reaction}) / 1.25$ . Structural strength ratings in chart are indicated with an asterisk (\*).
8. Rated loads are based on freely suspended loads. No attempt shall be made to drag a load horizontally on the ground in any direction.
9. The user shall operate at reduced ratings to allow for adverse job conditions, such as: Soft or uneven ground, out of level conditions, high winds, side loads, pendulum action, jerking or sudden stopping of loads, hazardous conditions, experience of personnel, two machine lifts, traveling with loads, electric wires, etc., (side pull on boom or jib is hazardous). Derating of the cranes lifting capacity is required when wind speed exceeds 20 MPH. The center of the lifted load must never be allowed to move more than 3' feet off the center line of the base boom section due to the effects of wind, inertia, or any combination of the two.  
 "Use 2 feet off the center line of the base boom for a two section boom, 3 feet for a three section boom, or 4 feet for a four section boom."
10. The maximum load which can be telescoped is not definable, because of variations in loadings and crane maintenance, but it is permissible to attempt retraction and extension if load ratings are not exceeded.
11. Load ratings are dependent upon the crane being maintained according to manufacturer's specifications.
12. It is recommended that load handling devices, including hooks, and hook blocks, be kept away from boom head at all times.
13. **FOR TRUCK ONLY:** 360° capacities apply only to machines equipped with a front outrigger jack and all five (5) outrigger jacks properly set. If the front (5th) outrigger jack is not properly set, the work area is restricted to the over side and over rear areas as shown on the Crane Working Positions diagram. Use the 360° load ratings in the overside work.



WE RESERVE THE RIGHT TO AMEND THESE SPECIFICATIONS AT ANY TIME WITHOUT NOTICE. THE ONLY WARRANTY APPLICABLE IS OUR STANDARD WRITTEN WARRANTY APPLICABLE TO THE PARTICULAR PRODUCT AND SALE. WE MAKE NO OTHER WARRANTY, EXPRESSED OR IMPLIED.

**Bigge Crane and Rigging Co.**

10700 Bigge Avenue  
San Leandro, CA 94577  
Phone: (888) 337-BIGGE or (510) 638-8100  
Fax: (510) 639-4053  
Email: info@bigge.com  
Web site: www.bigge.com

 **TEREX CRANES**  
Waverly, Iowa

TEREX CRANES, INC.  
106 12th Street S.E. • Waverly, IA 50677-9466 USA  
(319) 352-3920 • FAX: (319) 352-5727

