

KOBELCO

HYDRAULIC CRAWLER CRANE

CK2500-II

LUFFING JIB LIFTING
CAPACITIES

Max. Lifting Capacity with Luffing Jib: 118,000 lbs

Max. Boom Length + Luffing Jib Length: 200 ft + 170 ft

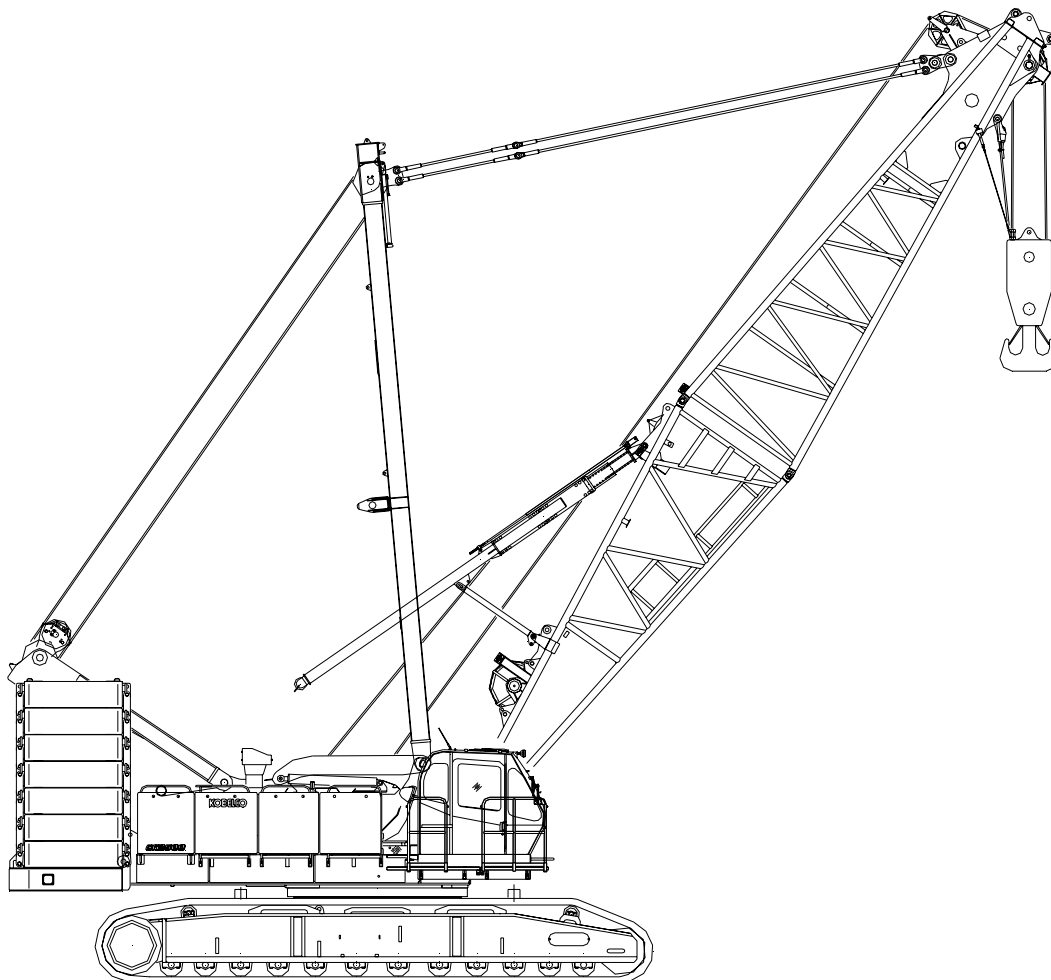

SPECIFICATIONS FOR CK2500-II CRAWLER CRANE

LUFFING JIB

The Kobelco CK2500-II Crawler Crane is designed from the ground up for reliable operation, convenient maintenance and easy transport. Please consult your Kobelco distributor for additional information regarding specifications, operating parameters and maintenance requirements.

1. GENERAL DESCRIPTION

Type	Crawler mounted, fully revolving
Maximum lifting capacity with luffing jib	118,000 lbs x 45' (53.5 ton x 13.7m)
Maximum boom length	200' (61.0 m)
Maximum luffing jib length	170' (51.8 m)
Working weight	Approx. 502,600 lbs (228 ton) (Including upper and lower machine, counterweights, 70' boom + 70' jib, hook block)
Ground bearing pressure (with 70' boom + 70' jib)	Approx. 15.4 psi (106 kPa)

2. WORKING SPEED

Hoist line speed (front and rear drum)	360 ~ 10 ft/min (110 ~ 3 m/min)
Lowering line speed (front and rear drum)	360 ~ 10 ft/min (110 ~ 3 m/min)
Boom hoist line speed	144 ~ 6.6 ft/min (44 ~ 2 m/min)
Boom lowering line speed	144 ~ 6.6 ft/min (44 ~ 2 m/min)
Jib hoist line speed	130~6.6 ft/min (40~2 m/min)
Jib Lowering line speed	130~6.6 ft/min (40~2 m/min)
Swing speed	2.2 rpm (2.2 min ⁻¹)
Travel speed (High / Low)	0.69 / 0.44 mph (1.1 / 0.7 km/hour)

Line speed based on single line, no load and first layer of rope on the drum. Line speed is controllable by Dial-type Speed Control System.

3. LUFFING JIB ATTACHMENTS

3.1 Boom

The welded lattice construction uses tubular, high-tension steel chords with pin connections between sections, extendible up to 200' (61.0 m).

Basic boom length	70' (21.3 m)
Boom tip section (with pin connected boom point sheave)	3.3' (1.00 m)
Taper Boom Insert	11.7' (3.60 m)
Boom insert section	10' (3.05m) + 20' (6.10 m)
Boom base section	25' (7.62 m)
Maximum boom length	200' (61.0 m)

3.2 Boom insert

Boom insert is available to provide extension capabilities. They feature welded lattice construction with tubular, high-tension strength steel chords and pin connections.

Boom insert 10' (3.05 m), 20' (6.10 m), 40' (12.2 m)

3.3 Jib

The jib employs welded lattice construction with tubular, high-tension steel chords with pin connections between sections, extendible up to 170' (51.8m).

Basic jib length	70' (21.3 m)
Jib insert	10' (3.05 m) + 20' (6.10m)
Jib tip section	21' (6.40 m)
Jib base section	19' (5.79 m)
No. of point sheaves	2
Maximum lift capacity	118,000 lbs (53.5 ton)
Maximum jib length	170' (51.8 m)
Insert jib length	10'(3.05 m), 20' (6.10 m), 40' (12.2 m)

Jib boom inserts are available to provide extension capabilities. They feature welded lattice construction with tubular, high-tension strength steel chords and pin connections.

3.4 Auxiliary sheave

One (1) sheave with rollers, required during erection of jib.

3.5 Diameter of wire ropes

Hoist rope	1" (25.4 m)
Jib hoist rope (10 parts)	7/8" (22.0 m)
Boom hoist rope (16 parts)	1-1/32" (26.0 m)
Boom suspension rope	1-5/16" (34.0 m)
Jib suspension rope	1-5/16" (34.0 m)
Strut suspension rope	1-5/16" (34.0 m)

3.6 Boom hoist reeving

Sixteen (16) parts of 1-5/32" (26.0 mm) dia. high strength wire rope.

3.7 Jib hoist reeving

Ten (10) parts of 7/8" (22.0 mm) dia. high strength wire rope.

3.8 Backstops

Required for all boom and jib length.



4. JIB HOIST DRUM

Jib hoist drum (3rd drum on straight crane)

Powered by hydraulic motor through planetary reducer.

Drum Single drum

Grooved for 7/8" (22.0 m) dia. wire rope

Brake A spring-set, hydraulically released

multiple-disc brake is internally configured in the

hoist motor and is operated through a

counter-balance valve.

External ratchet for locking drum.

5. SAFETY DEVICES

Function lock lever

Hook over hoist shut off (Anti-two-block)

Boom and jib over hoist limit switch

Boom angle indicator

Signal horn

Boom and jib hoist drum lock

Front and rear hoist drum lock

Swing lock

Swing alarm (Buzzer and lamps)

Boom backstops

Jib backstops

Strut backstops

Over load preventive device (Load Moment Indicator)

All specifications are subject to change without notice.

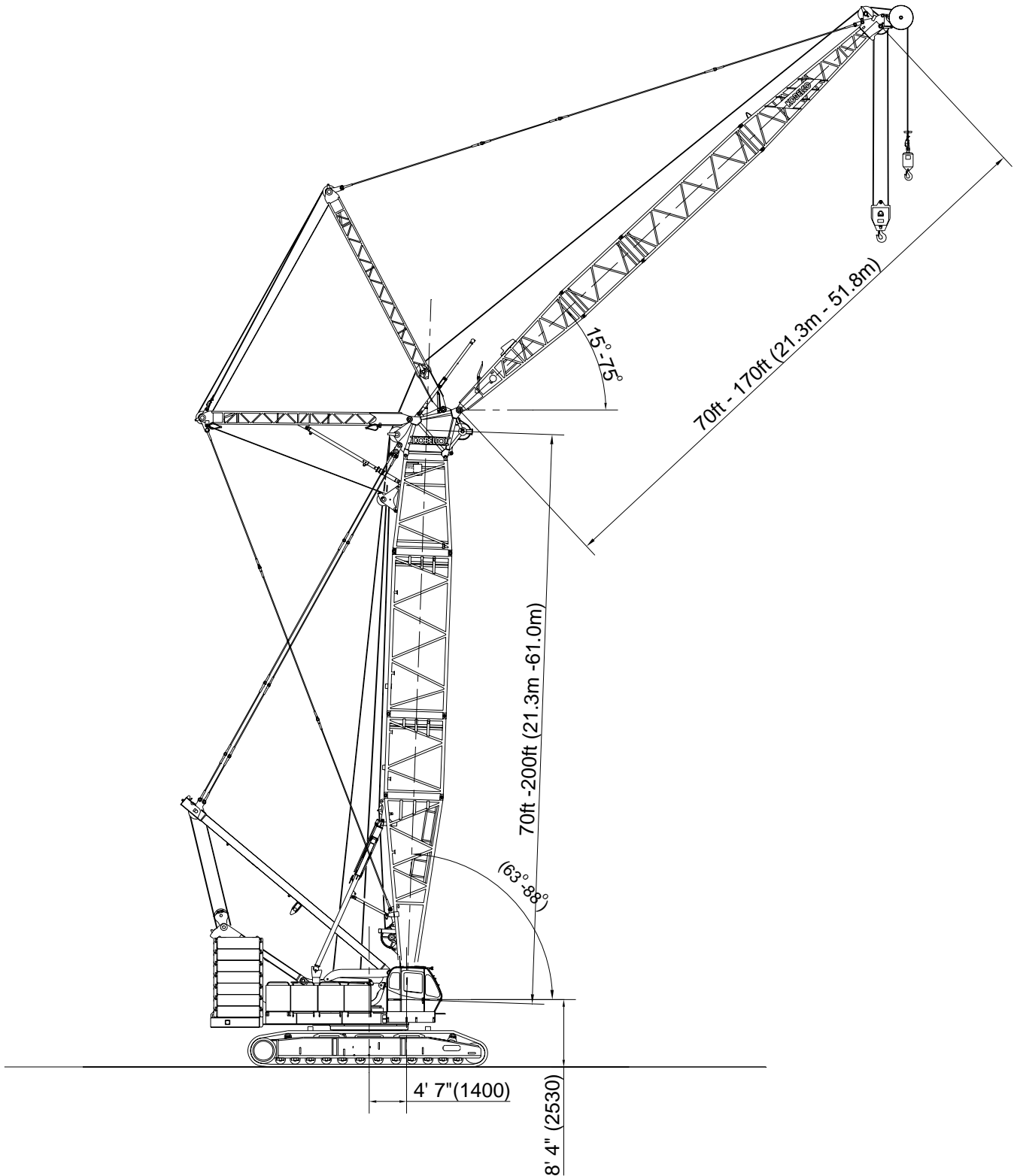

Luffing Jib Dimensions

KOBELCO

Luffing Jib Working Ranges



BOOM ANGLE 88°

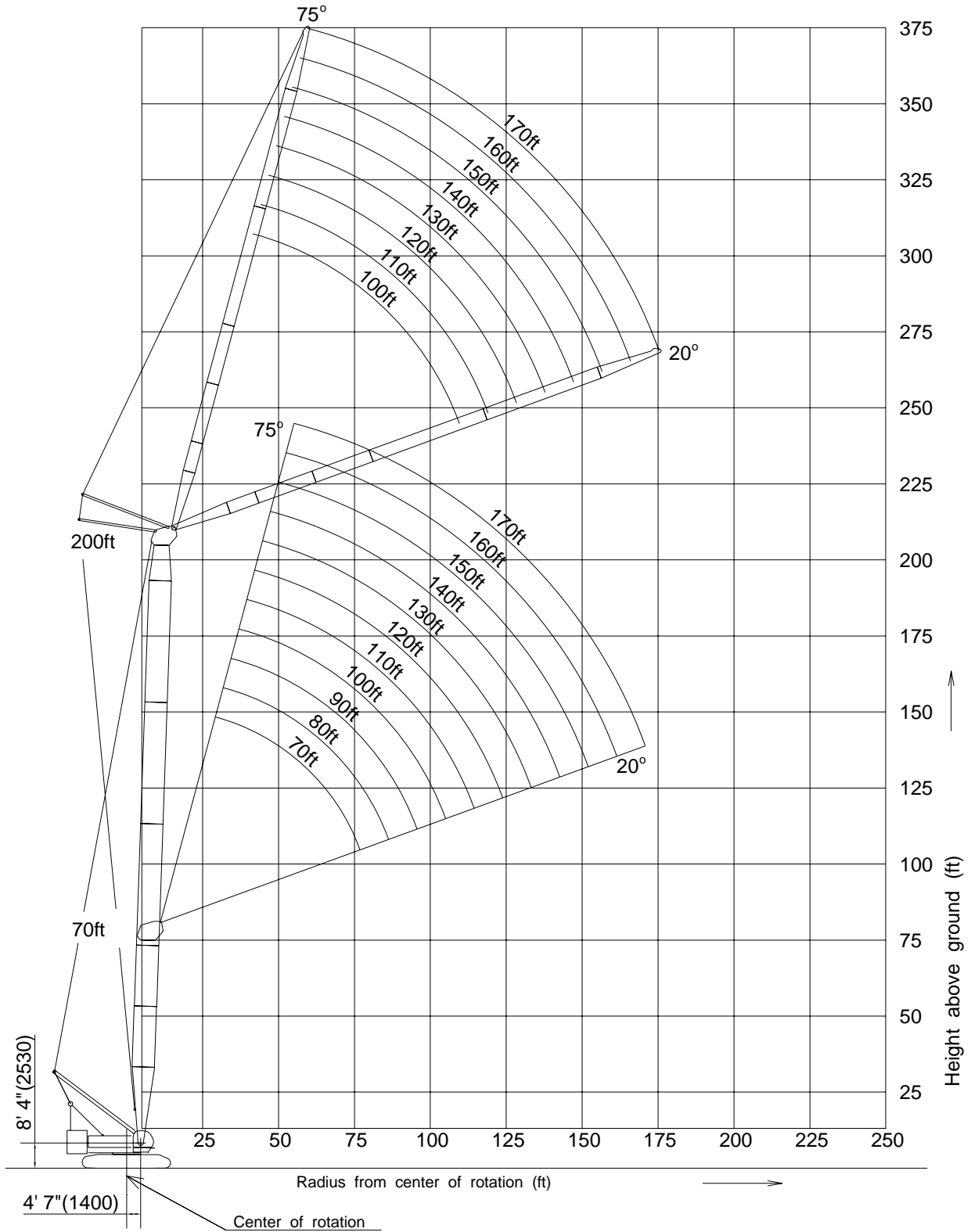

Luffing Jib Working Ranges



BOOM ANGLE 78°

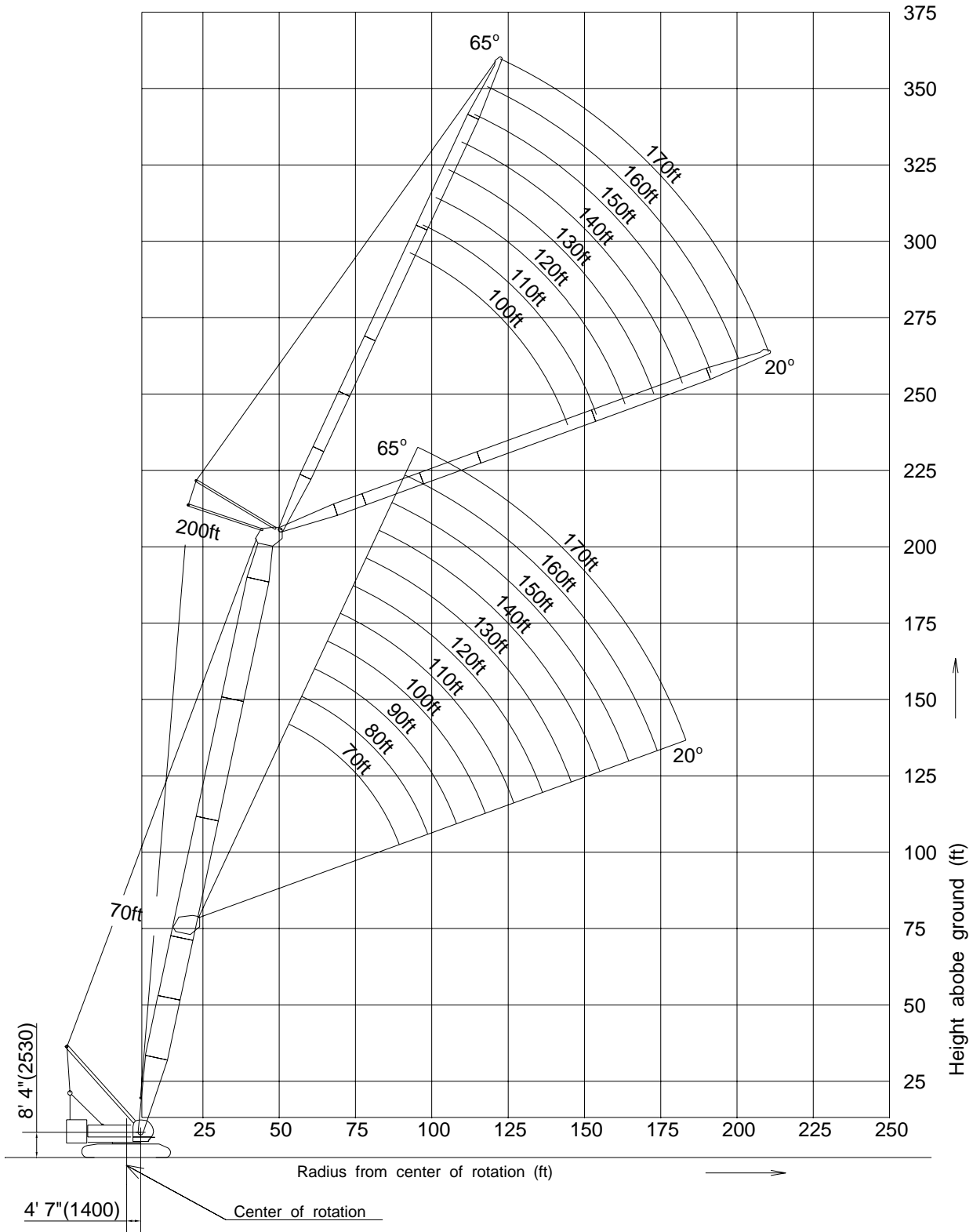

Luffing Jib Working Ranges



BOOM ANGLE 68°

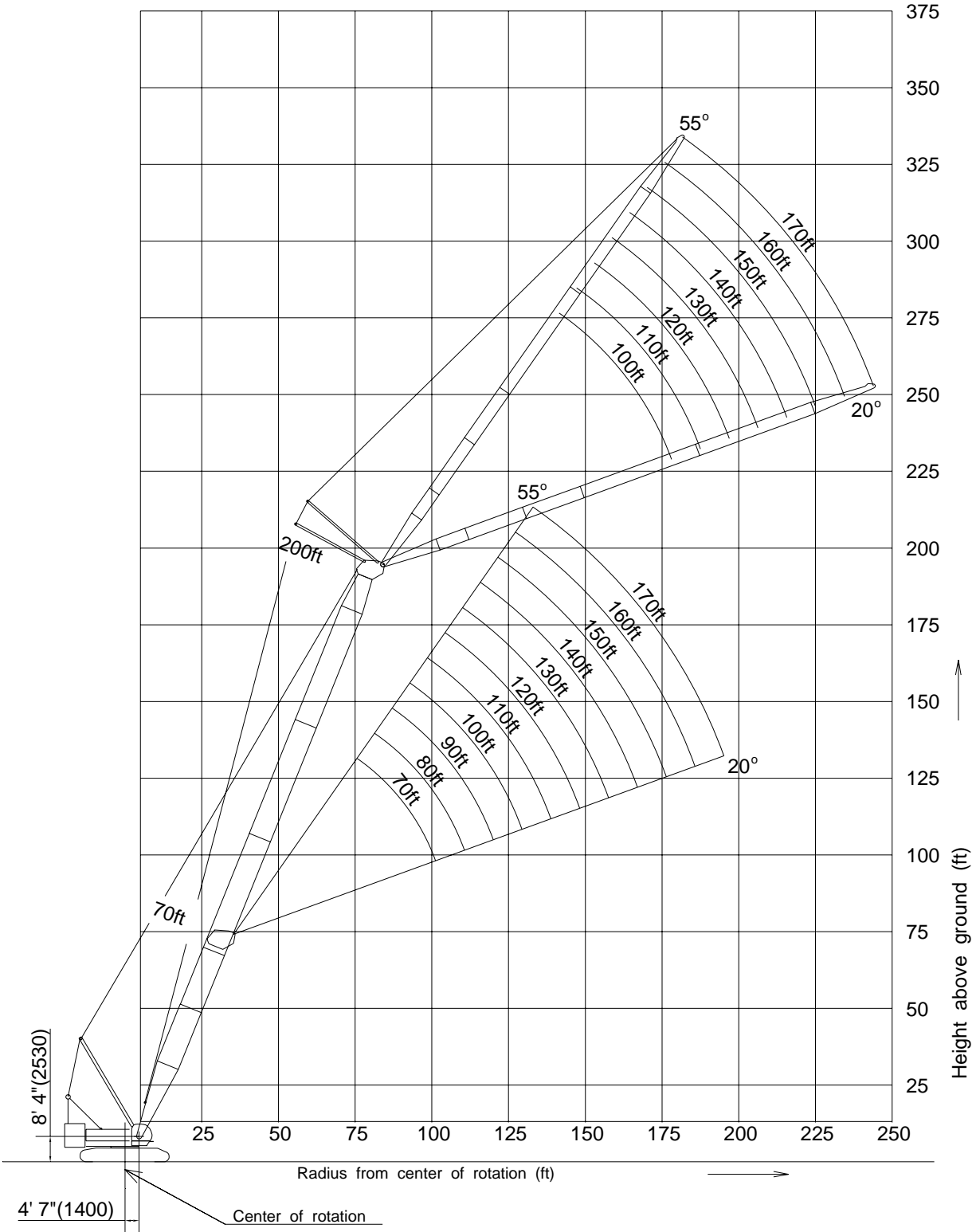

Boom and Guy Line Arrangement (Luffing Jib) 1/2



SYMBOL	DIA in (mm)	LENGTH ft(m)
B	1-5/16" (34)	10 (3.05)
C	1-5/16" (34)	20 (6.10)
D	1-5/16" (34)	40 (12.2)
F	1-5/16" (34)	18 (5.50)
N	1-5/16" (34)	6.4 (1.96)
Q	1-5/16" (34)	12.1 (3.69)
W	1-5/16" (34)	24.3 (7.42)

For most efficient use of this machine, boom and guy line arrangement must be correctly observed as shown.

70ft (21.3m)

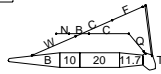

80ft (24.4m)

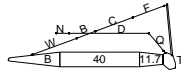

90ft (27.4m)

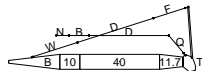

100ft (30.5m)

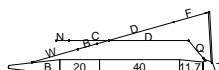

110ft (33.5m)

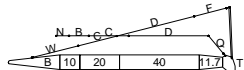

120ft (36.6m)

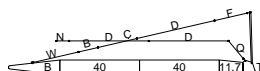

130ft (39.6m)

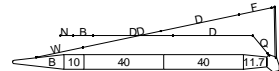

140ft (42.7m)

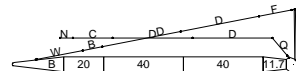

150ft (45.7m)

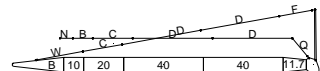

160ft (48.8m)

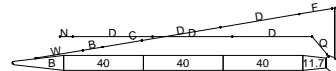

170ft (51.8m)

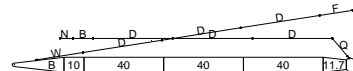

180ft (54.9m)

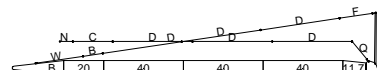

190ft (57.9m)

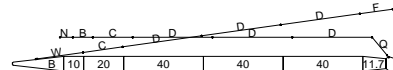

200ft (61.0m)



Boom and Guy Line Arrangement (Luffing Jib) 2/2

SYMBOL	DIA in (mm)	LENGTH ft(m)
B	1-5/16" (34)	10 (3.05)
C	1-5/16" (34)	20 (6.10)
D	1-5/16" (34)	40 (12.2)
F	1-5/16" (34)	18 (5.50)
G	1-5/16" (34)	18 (5.50)

For most efficient use of this machine, jib and guy line arrangement must be correctly observed as shown.

70ft (21.3m)

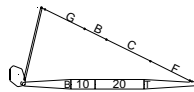

80ft (24.4m)

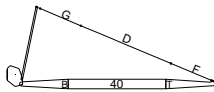

90ft (27.4m)

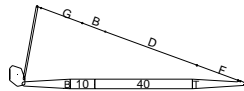

100ft (30.5m)

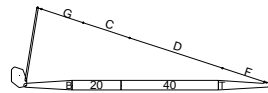

110ft (33.5m)

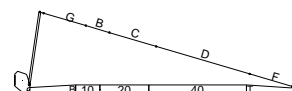

120ft (36.6m)

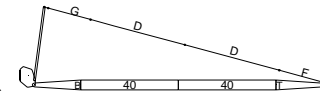

130ft (39.6m)

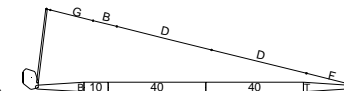

140ft (42.7m)

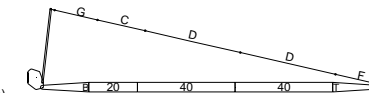

150ft (45.7m)

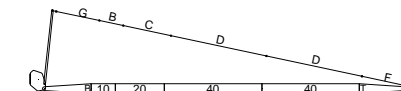

160ft (48.8m)

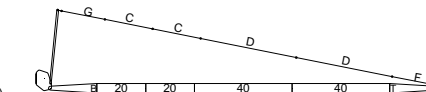

170ft (51.8m)

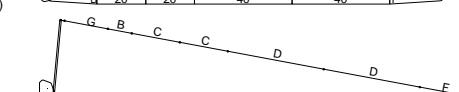

Rating Chart Supplemental Data



1. Rated loads included in the charts are the maximum allowable freely suspended loads at a given boom length, boom angle and load radius, and have been determined for the machine standing level on firm supporting surface under ideal operating conditions. The user must limit or de-rate rated loads to allow for adverse conditions (such as soft or uneven ground, out-of-level conditions, wind, side loads, pendulum action, jerking or sudden stopping of loads, inexperience of personnel, multiple machine lifts, and traveling with a load).
2. Capacities do not exceed 75% of minimum tipping loads. Capacities based on factors other than machine stability such as structural competence are shown by asterisk* in the charts.
3. The machine must be reeved and set-up as stated in the operation manual and all the instruction manuals if these manuals are missing, obtain replacements.
 - Boom backstops are required for all boom lengths.
 - Gantry must be fully raised position for all operations.
 - The crane must be leveled to within 1% on a firm supporting surface.
4. Do not attempt to lift where no radius on load is listed as crane may tip or collapse.
5. Attempting to lift more than rated loads may cause machine to tip or collapse. Do not tip machine to determine capacity.
6. Weight of hooks, hook blocks, slings and other lifting devices are a part of the total load. Their total weight must be subtracted from the rated load to obtain the weight that can be lifted.
7. The total load that can be lifted over a jib is limited by rated jib loads.
8. The total load that can be lifted over an auxiliary sheave should not exceed 29,500 lbs.
9. The boom should be erected over the front of the crawlers, not laterally. When erecting and lowering the boom length of 190 ft (57.9 m) or over, the blocks for erection must be placed at the end of the crawlers.
10. Least stable position is over the side.

11. Luffing boom and jib combinations.

		Jib Length (ft)										
		70	80	90	100	110	120	130	140	150	160	170
Boom Length (ft)	70	0	0	0	0	0	0	0	0	0	0	0
	80	0	0	0	0	0	0	0	0	0	0	0
	90	0	0	0	0	0	0	0	0	0	0	0
	100	0	0	0	0	0	0	0	0	0	0	0
	110	0	0	0	0	0	0	0	0	0	0	0
	120	0	0	0	0	0	0	0	0	0	0	0
	130	0	0	0	0	0	0	0	0	0	0	0
	140	0	0	0	0	0	0	0	0	0	0	0
	150	0	0	0	0	0	0	0	0	0	0	0
	160	0	0	0	0	0	0	0	0	0	0	0
	170	0	0	0	0	0	0	0	0	0	0	0
	180	0	0	0	0	0	0	0	0	0	0	0
	190	0	0	0	0	0	0	0	0	0	0	0
200	X	X	X	0	0	0	0	0	0	0	0	

0: Combination which is allowed.

X: Combination which is not allowed.

12. Maximum number of reeving parts of lines for hoist rope

(1) Luffing jib

		Jib Length (ft)										
		70	80	90	100	110	120	130	140	150	160	170
Boom Length (ft)	70	4	4	4	4	4	4*	4*	4*	2	2	2
	80	4	4	4	4	4	4*	4*	4*	2	2	2
	90	4	4	4	4	4	4*	4*	4*	2	2	2
	100	4	4	4	4	4	4*	4*	4*	2	2	2
	110	4	4	4	4	4	4*	4*	4*	2	2	2
	120	4	4	4	4	4	4*	4*	4*	2	2	2
	130	4	4	4	4	4	4*	4*	4*	2	2	2
	140	4	4	4	4	4*	4*	4*	4*	2	2	2
	150	4	4	4*	4*	4*	4*	4*	4*	2	2	2
	160	4	4*	4*	4*	4*	4*	4*	4*	2	2	2
	170	4*	4*	4*	4*	4*	4*	4*	4*	2	2	2
	180	4*	4*	4*	4*	4*	4*	4*	4*	2	2	2
	190	4*	4*	4*	4*	4*	4*	4*	4*	2	2	2
200	X	X	X	4*	2	2	2	2	2	2	2	

X: Combination which is not allowed.

*: In case of using rear drum, number of reeving parts line of hoist rope should be 3 parts line.

(2) Crane boom with luffing jib attached

		Jib Length (ft)										
		70	80	90	100	110	120	130	140	150	160	170
Boom Length (ft)	70	8	8	8	8	8	8	8	8	8	8	8
	80	8	8	8	8	8	8	8	8	8	8	8
	90	8	8	8	8	8	8	8	8	8	8	8
	100	8	8	8	8	8	8	8	8	8	8	8
	110	8	8	8	8	8	8	8	8	8	8	8
	120	8	8	8	8	8	8	8	8	8	8	6
	130	8	8	8	8	8	8	6	6	6	6	6
	140	8	8	8	8	8	8	6	6	6	6	6
	150	8	8	6	6	6	6	6	6	6	6	6
	160	6	6	6	6	6	6	6	6	6	6	6
	170	6	6	6	6	6	6	6	6	6	6	6
	180	6	6	6	6	6	6	6	6	6	4	4
	190	6	6	6	6	6	6	6	6	6	4	4
200	X	X	X	6	6	4	4	4	4	4	4	

X: Combination which is not allowed.

Rating Chart Supplemental Data



13. Maximum hoist load for number of reeving parts of line for hoist rope.

Main boom hoist loads

Parts of lines	1	2	(3)	4
Maximum loads (lbs)	29,500	59,000	85,500	118,000

Parts of lines	(5)	6	7	8
Maximum loads (lbs)	147,500	177,000	206,500	200,000

Jib hoist loads

Parts of lines	1	2	(3)	4
Maximum loads (lbs)	29,500	59,000	88,500	118,000

Auxiliary sheave hoist loads

Parts of lines	1
Maximum loads (lbs)	29,500

Parts of lines with parenthesis () is not recommended for lifting.

14. Lifting capacities shown apply only to the machine as originally manufactured and designed by KOBELCO CRANES CO., LTD. Modifications to this machine or use of equipment other than that specified can reduce operating capacity.

15. Designed and rated to comply with ANSI Code B30.5.

Operation of this equipment in excess of rated loads or disregard of instruction voids the warranty.



CK2500-II Luffing Jib Rating Loads in Pounds

15 Counterweights + 2 Low Weights

Refer to notes page 8

70' Boom							70' Boom						
Load Radius (ft.)	70 ft Jib						Load Radius (ft.)	80 ft Jib					
	Boom Angle (deg.)							Boom Angle (deg.)					
	88	83	78	73	68	63		88	83	78	73	68	63
32	118,000 *						32						
35	118,000 *						35	118,000 *					
40	118,000 *						40	118,000 *					
45	118,000 *	118,000 *					45	118,000 *					
50	111,500 *	117,500 *					50	112,400 *	117,500 *				
55	97,000 *	114,000 *	114,000				55	97,900 *	114,000 *				
60	85,500 *	100,700 *	102,000				60	86,200 *	101,600 *	102,000			
65	76,000 *	88,600 *	93,000				65	76,900 *	89,300 *	92,600			
70	68,300 *	78,700 *	84,600	82,600			70	69,200 *	79,600 *	84,200			
75	58,400 *	70,500 *	77,600	75,600			75	62,600 *	71,400 *	77,300	75,400		
80		63,700 *	71,600	69,800	68,100		80	57,100 *	64,600 *	71,200	69,400		
85		52,400 *	65,700 *	64,800	63,200		85	49,100 *	58,800 *	66,100	64,300	62,800	
90			58,200 *	60,400	58,800	57,300	90		53,800 *	60,400 *	59,900	58,400	
95				56,400	55,100	53,500	95			55,100 *	56,000	54,600	53,300
100					51,500	50,200	100			49,300 *	52,600	51,300	50,000
110							110					45,600	44,300

70' Boom							70' Boom						
Load Radius (ft.)	90 ft Jib						Load Radius (ft.)	100 ft Jib					
	Boom Angle (deg.)							Boom Angle (deg.)					
	88	83	78	73	68	63		88	83	78	73	68	63
40	118,000 *						40	118,000 *					
45	118,000 *						45	118,000 *					
50	113,100 *	117,500					50	113,100 *					
55	98,300 *	114,000					55	98,500 *	114,000				
60	86,800 *	102,000 *					60	86,800 *	102,000 *				
65	77,300 *	89,900 *	92,300				65	77,600 *	91,000 *				
70	69,600 *	80,000 *	84,000				70	69,600 *	80,900 *	83,700			
75	63,200 *	71,800 *	77,100				75	63,200 *	72,700 *	76,700			
80	57,700 *	65,000 *	71,000	69,200			80	57,700 *	65,900 *	70,700			
85	52,900 *	59,300 *	65,900	64,100			85	52,900 *	59,900 *	65,400	63,900		
90	48,700 *	54,400 *	60,800 *	59,700	58,200		90	48,900 *	55,100 *	61,000	59,500		
95	41,800 *	50,000 *	55,700 *	55,700	54,400		95	45,200 *	50,700 *	55,700 *	55,700	54,000	
100		45,800 *	51,300 *	52,400	50,900		100	41,600 *	46,700 *	51,300 *	52,200	50,400	
110			42,500 *	46,500	45,200	44,000	110		39,900 *	44,000 *	46,300	44,900	43,800
120					40,500	39,400	120			37,000 *	41,600	40,300	39,200
130							130					36,300	35,500

CK2500-II Luffing Jib Rating Loads in Pounds

15 Counterweights + 2 Low Weights

Refer to notes page 8

70' Boom							70' Boom						
Load Radius (ft.)	110 ft Jib						Load Radius (ft.)	120 ft Jib					
	Boom Angle (deg.)							Boom Angle (deg.)					
	88	83	78	73	68	63		88	83	78	73	68	63
45	113,500 *						45	88,500 *					
50	111,700 *						50	88,500 *					
55	100,100 *						55	87,900 *					
60	88,100 *	102,000 *					60	82,900 *					
65	78,700 *	91,200 *					65	78,200 *	82,400 *				
70	70,700 *	81,300 *					70	70,700 *	78,000 *				
75	64,300 *	72,900 *	76,700				75	64,100 *	74,000 *				
80	58,600 *	66,100 *	70,700				80	58,600 *	67,000 *	70,500			
85	53,800 *	60,400 *	65,700				85	53,800 *	61,000 *	65,200			
90	49,600 *	55,300 *	61,000	59,500			90	49,600 *	56,000 *	60,800			
95	46,000 *	50,900 *	56,600 *	55,500			95	45,800 *	51,500 *	56,400 *	55,500		
100	42,700 *	47,100 *	52,200 *	52,000	50,700		100	42,500 *	47,800 *	52,000 *	52,000		
110	36,600 *	40,700 *	44,700 *	46,300	44,900		110	37,000 *	41,200 *	44,700 *	46,000	44,500	
120		35,000 *	39,000 *	41,400	40,300	39,200	120	31,900 *	36,100 *	38,800 *	41,400	39,900	39,000
130				37,200 *	36,600	35,500	130		31,000 *	34,100 *	37,400	36,100	35,200
140					33,200	32,400	140				33,000 *	32,800	32,100
150							150					30,200	29,300

70' Boom							70' Boom						
Load Radius (ft.)	130 ft Jib						Load Radius (ft.)	140 ft Jib					
	Boom Angle (deg.)							Boom Angle (deg.)					
	88	83	78	73	68	63		88	83	78	73	68	63
50	77,300 *						50	65,900 *					
55	72,900 *						55	64,100 *					
60	68,700 *						60	60,100 *					
65	64,800 *	69,800 *					65	56,800 *					
70	61,500 *	65,900 *					70	53,800 *	55,500 *				
75	58,400 *	62,400 *					75	50,900 *	52,600 *				
80	55,500 *	59,300 *					80	48,500 *	50,000 *				
85	53,100 *	56,400 *	60,100 *				85	46,000 *	47,600 *	52,400 *			
90	50,200 *	53,800 *	57,300 *				90	44,000 *	45,400 *	49,800 *			
95	46,500 *	51,500 *	54,600 *				95	42,100 *	43,400 *	47,400 *			
100	43,200 *	47,600 *	52,200 *	51,800			100	40,300 *	41,400 *	45,200 *			
110	37,700 *	41,200 *	45,200 *	45,800			110	37,200 *	38,300 *	41,400 *	42,500 *		
120	33,000 *	36,100 *	39,200 *	41,000	39,900		120	32,800 *	35,500 *	38,100 *	39,200 *	39,400	
130	28,400 *	31,700 *	34,600 *	37,200	36,100	35,000	130	29,100 *	32,100 *	34,300 *	36,300 *	35,700	
140		27,500 *	30,600 *	33,000 *	32,800	31,700	140	25,100 *	28,600 *	30,400 *	33,500 *	32,400	31,700
150				29,300 *	29,900	29,100	150		24,900 *	27,100 *	29,700 *	29,500	28,800
160					27,500	26,600	160				26,400 *	27,300	26,600
170							170					25,100	24,400



CK2500-II Luffing Jib Rating Loads in Pounds

15 Counterweights + 2 Low Weights

Refer to notes page 8

70' Boom							70' Boom						
Load Radius (ft.)	150 ft Jib						Load Radius (ft.)	160 ft Jib					
	Boom Angle (deg.)							Boom Angle (deg.)					
	88	83	78	73	68	63		88	83	78	73	68	63
55	53,100 *						55	46,000 *					
60	50,000 *						60	43,200 *					
65	47,100 *						65	40,700 *					
70	44,500 *						70	38,300 *					
75	42,300 *	45,400 *					75	36,300 *	39,000 *				
80	40,100 *	42,900 *					80	34,300 *	37,000 *				
85	38,300 *	40,700 *					85	32,800 *	35,000 *				
90	36,600 *	38,800 *	41,400 *				90	31,000 *	33,200 *				
95	34,800 *	37,000 *	39,400 *				95	29,700 *	31,700 *	33,700 *			
100	33,500 *	35,500 *	37,700 *				100	28,400 *	30,200 *	32,100 *			
110	30,800 *	32,400 *	34,300 *	36,300 *			110	26,000 *	27,500 *	29,100 *			
120	28,400 *	29,900 *	31,500 *	33,200 *			120	23,800 *	25,300 *	26,600 *	28,200 *		
130	26,400 *	27,700 *	29,300 *	30,600 *	32,100 *		130	22,000 *	23,300 *	24,600 *	26,000 *	27,300 *	
140	24,600 *	26,000 *	27,100 *	28,400 *	29,900 *	31,300	140	20,500 *	21,600 *	22,700 *	23,800 *	25,100 *	
150	22,900 *	24,200 *	25,300 *	26,600 *	27,700 *	28,800	150	19,100 *	20,000 *	21,100 *	22,000 *	23,100 *	24,200 *
160		22,200 *	23,800 *	24,900 *	26,000 *	26,400	160	17,800 *	18,700 *	19,600 *	20,700 *	21,600 *	22,400 *
170				23,500 *	24,400 *	24,400	170		17,600 *	18,500 *	19,100 *	20,000 *	20,900 *
180					22,900	22,700	180				18,000 *	18,900 *	19,600 *
190							190					17,800 *	18,500 *

70' Boom							70' Boom						
Load Radius (ft.)	170 ft Jib						Load Radius (ft.)	170 ft Jib					
	Boom Angle (deg.)							Boom Angle (deg.)					
	88	83	78	73	68	63		88	83	78	73	68	63
60	38,500 *												
65	36,300 *												
70	34,100 *												
75	32,100 *												
80	30,600 *	32,800 *											
85	28,800 *	31,000 *											
90	27,500 *	29,500 *											
95	26,200 *	28,000 *											
100	24,900 *	26,600 *	28,400 *										
110	22,700 *	24,200 *	25,700 *										
120	20,700 *	22,000 *	23,300 *	24,900 *									
130	19,100 *	20,200 *	21,300 *	22,700 *									
140	17,600 *	18,700 *	19,600 *	20,700 *	21,800 *								
150	16,300 *	17,100 *	18,000 *	19,100 *	20,000 *								
160	15,200 *	16,000 *	16,700 *	17,600 *	18,500 *	19,600 *							
170	14,100 *	14,900 *	15,600 *	16,500 *	17,100 *	18,000 *							
180		13,800 *	14,500 *	15,400 *	16,000 *	16,700 *							
190				14,300 *	14,900 *	15,600 *							
200						14,700 *							



CK2500-II Luffing Jib Rating Loads in Pounds

15 Counterweights + 2 Low Weights

Refer to notes page 8

80' Boom							80' Boom						
Load Radius (ft.)	70 ft Jib						Load Radius (ft.)	80 ft Jib					
	Boom Angle (deg.)							Boom Angle (deg.)					
	88	83	78	73	68	63		88	83	78	73	68	63
32	118,000 *						32						
35	118,000 *						35	118,000 *					
40	118,000 *						40	118,000 *					
45	118,000 *	118,000					45	118,000 *					
50	112,600 *	117,000					50	113,500 *	117,000				
55	97,600 *	112,500					55	98,500 *	112,500				
60	85,900 *	100,800 *	100,800				60	86,800 *	100,800				
65	76,500 *	90,700 *	92,100				65	77,300 *	90,900 *	91,700			
70	68,700 *	80,900 *	84,000	81,500			70	69,400 *	81,500 *	83,500			
75	59,700 *	72,300 *	76,900	74,700			75	63,000 *	73,200 *	76,500	74,300		
80		65,000 *	71,000	68,700			80	57,300 *	66,100 *	70,500	68,500		
85		56,000 *	65,700	63,900	61,900		85	50,000 *	59,900 *	65,400	63,500		
90			61,200	59,500	57,700		90		54,600 *	60,800	59,000	57,300	
95				55,500	54,000	52,400	95		47,400 *	56,800	55,300	53,500	
100				52,000	50,700	49,100	100			52,200 *	51,800	50,200	48,700
110						43,600	110					44,500	43,200
120							120						38,800

80' Boom							80' Boom						
Load Radius (ft.)	90 ft Jib						Load Radius (ft.)	100 ft Jib					
	Boom Angle (deg.)							Boom Angle (deg.)					
	88	83	78	73	68	63		88	83	78	73	68	63
40	118,000 *						40	118,000 *					
45	118,000 *						45	118,000 *					
50	114,200 *						50	114,200 *					
55	99,200 *	112,500					55	99,200 *	112,500				
60	87,300 *	100,800					60	87,500 *	100,800				
65	77,800 *	92,000 *					65	78,000 *	92,000 *				
70	70,100 *	83,100 *	83,300				70	70,100 *	83,100 *	82,900			
75	63,500 *	74,500 *	76,200				75	63,500 *	74,500 *	75,800			
80	57,900 *	67,200 *	70,300	68,500			80	57,900 *	67,400 *	69,800			
85	53,100 *	61,200 *	65,200	63,500			85	53,100 *	61,200 *	64,800	63,000		
90	48,700 *	56,000 *	60,600	59,000			90	48,900 *	56,200 *	60,400	58,600		
95	42,700 *	51,300 *	56,800	55,300	53,300		95	45,200 *	51,500 *	56,400	54,900		
100		47,400 *	52,900 *	51,800	50,000		100	42,100 *	47,600 *	52,900	51,300	49,600	
110			44,900 *	46,000	44,300	43,200	110		41,000 *	45,400 *	45,600	43,800	
120					39,600	38,800	120			39,000 *	41,000	39,400	38,300
130						35,000	130					35,500	34,600
140							140						31,500

CK2500-II Luffing Jib Rating Loads in Pounds

15 Counterweights + 2 Low Weights

Refer to notes page 8

80' Boom							80' Boom						
Load Radius (ft.)	110 ft Jib						Load Radius (ft.)	120 ft Jib					
	Boom Angle (deg.)							Boom Angle (deg.)					
	88	83	78	73	68	63		88	83	78	73	68	63
45	113,700 *						45	88,500 *					
50	112,000 *						50	88,500 *					
55	100,700 *						55	88,200 *					
60	88,800 *	100,800					60	83,100 *					
65	79,100 *	92,000 *					65	78,400 *	83,500 *				
70	71,200 *	83,300 *					70	71,200 *	78,900 *				
75	64,600 *	74,700 *	76,000				75	64,300 *	74,900 *				
80	59,000 *	67,600 *	70,100				80	58,800 *	68,500 *	69,600			
85	54,000 *	61,500 *	65,000				85	54,000 *	62,400 *	64,600			
90	49,800 *	56,400 *	60,600	58,600			90	49,800 *	57,100 *	60,100			
95	46,000 *	52,000 *	56,600	54,600			95	46,000 *	52,400 *	56,200	54,600		
100	42,700 *	48,000 *	53,100	51,300			100	42,700 *	48,500 *	52,600	51,100		
110	37,200 *	41,400 *	46,000 *	45,600	44,000		110	37,200 *	41,800 *	46,000 *	45,400	43,600	
120		36,100 *	39,900 *	40,700	39,400	38,100	120	32,400 *	36,600 *	39,900 *	40,700	39,000	
130			34,800 *	37,000	35,700	34,300	130		32,100 *	34,800 *	36,800	35,200	34,300
140					32,400	31,300	140			30,800 *	33,500	32,100	31,000
150						28,600	150					29,300	28,400
160							160						26,200

80' Boom							80' Boom						
Load Radius (ft.)	130 ft Jib						Load Radius (ft.)	140 ft Jib					
	Boom Angle (deg.)							Boom Angle (deg.)					
	88	83	78	73	68	63		88	83	78	73	68	63
50	77,300 *						50	65,900 *					
55	73,200 *						55	64,300 *					
60	69,000 *						60	60,400 *					
65	65,000 *	70,700 *					65	57,100 *					
70	61,700 *	66,800 *					70	53,800 *	56,200 *				
75	58,600 *	63,200 *					75	51,100 *	53,300 *				
80	55,700 *	59,900 *					80	48,500 *	50,400 *				
85	53,100 *	57,100 *	61,500 *				85	46,300 *	48,000 *				
90	50,400 *	54,400 *	58,400 *				90	44,000 *	45,800 *	50,900 *			
95	46,700 *	52,000 *	55,500 *				95	42,100 *	43,800 *	48,500 *			
100	43,400 *	48,500 *	52,600 *	50,900			100	40,300 *	41,800 *	46,000 *			
110	37,700 *	41,800 *	46,500 *	45,200			110	37,200 *	38,500 *	42,100 *	43,600 *		
120	33,000 *	36,600 *	40,300 *	40,300	39,000		120	32,800 *	35,700 *	38,800 *	40,100 *		
130	29,100 *	32,100 *	35,500 *	36,600	35,200		130	29,100 *	32,600 *	35,000 *	36,300	34,800	
140		28,400 *	31,300 *	33,200	31,900	30,800	140	25,500 *	28,800 *	31,000 *	33,000	31,700	30,800
150			27,700 *	30,400	29,300	28,200	150		25,700 *	27,500 *	30,200	28,800	28,000
160					26,900	26,000	160			24,600 *	27,300 *	26,400	25,700
170						24,000	170					24,400	23,800
180							180						22,000

CK2500-II Luffing Jib Rating Loads in Pounds

15 Counterweights + 2 Low Weights

Refer to notes page 8

80' Boom							80' Boom						
Load Radius (ft.)	150 ft Jib						Load Radius (ft.)	160 ft Jib					
	Boom Angle (deg.)							Boom Angle (deg.)					
	88	83	78	73	68	63		88	83	78	73	68	63
55	53,300 *						55	46,000 *					
60	50,000 *						60	43,400 *					
65	47,400 *						65	40,700 *					
70	44,700 *						70	38,500 *					
75	42,300 *	45,800 *					75	36,300 *					
80	40,300 *	43,400 *					80	34,600 *	37,400 *				
85	38,300 *	41,200 *					85	32,800 *	35,500 *				
90	36,600 *	39,200 *					90	31,300 *	33,700 *				
95	35,000 *	37,400 *	40,100 *				95	29,700 *	31,900 *				
100	33,500 *	35,700 *	38,300 *				100	28,400 *	30,400 *	32,600 *			
110	30,800 *	32,800 *	35,000 *	37,200 *			110	26,000 *	27,700 *	29,700 *			
120	28,400 *	30,200 *	32,100 *	34,100 *			120	24,000 *	25,500 *	27,100 *	28,800 *		
130	26,400 *	28,000 *	29,700 *	31,500 *	33,200 *		130	22,000 *	23,500 *	24,900 *	26,400 *		
140	24,600 *	26,000 *	27,500 *	29,100 *	30,600 *		140	20,500 *	21,800 *	23,100 *	24,400 *	25,700 *	
150	23,100 *	24,400 *	25,700 *	27,100 *	28,400 *	28,000	150	19,100 *	20,200 *	21,300 *	22,700 *	23,800 *	
160		23,100 *	24,000 *	25,300 *	26,600 *	25,500	160	17,800 *	18,900 *	19,800 *	20,900 *	22,000 *	23,300 *
170			22,700 *	23,800 *	24,600 *	23,500	170		17,600 *	18,700 *	19,600 *	20,700 *	21,600 *
180					22,700 *	21,800	180			17,600 *	18,500 *	19,400 *	20,200 *
190						20,200	190					18,000 *	18,900 *
200							200						18,000 *

80' Boom													
Load Radius (ft.)	170 ft Jib												
	Boom Angle (deg.)												
	88	83	78	73	68	63							
60	38,800 *												
65	36,300 *												
70	34,300 *												
75	32,400 *												
80	30,600 *	33,200 *											
85	29,100 *	31,500 *											
90	27,500 *	29,700 *											
95	26,200 *	28,200 *											
100	24,900 *	26,900 *	28,800 *										
110	22,700 *	24,400 *	26,200 *										
120	20,700 *	22,200 *	23,800 *	25,500 *									
130	19,100 *	20,500 *	21,800 *	23,100 *									
140	17,600 *	18,700 *	20,000 *	21,100 *	22,700 *								
150	16,300 *	17,400 *	18,500 *	19,600 *	20,700 *								
160	15,200 *	16,000 *	16,900 *	18,000 *	19,100 *	20,200 *							
170	14,100 *	14,900 *	15,800 *	16,700 *	17,600 *	18,700 *							
180		14,100 *	14,700 *	15,600 *	16,500 *	17,400 *							
190			13,800 *	14,500 *	15,400 *	16,000 *							
200					14,300 *	15,200 *							
210						14,300 *							

CK2500-II Luffing Jib Rating Loads in Pounds

15 Counterweights + 2 Low Weights

Refer to notes page 8

90' Boom							90' Boom						
Load Radius (ft.)	70 ft Jib						Load Radius (ft.)	80 ft Jib					
	Boom Angle (deg.)							Boom Angle (deg.)					
	88	83	78	73	68	63		88	83	78	73	68	63
32	118,000 *						32						
35	118,000 *						35	118,000 *					
40	118,000 *						40	118,000 *					
45	118,000 *						45	118,000 *					
50	113,700 *	116,900					50	114,600 *	116,900				
55	98,500 *	111,900					55	99,400 *	111,900				
60	86,600 *	100,900	100,900				60	87,500 *	100,900				
65	76,900 *	91,600 *	91,200				65	77,800 *	91,900	90,800			
70	69,000 *	82,700 *	83,100				70	69,800 *	83,200 *	82,600			
75	60,800 *	74,000 *	76,000	73,600			75	63,200 *	74,900 *	75,800			
80		66,500 *	70,300	67,900			80	57,500 *	67,400 *	69,800	67,400		
85		59,300 *	65,000	62,800	60,800		85	51,100 *	61,200 *	64,800	62,600		
90			60,600	58,600	56,600		90		55,700 *	60,400	58,200		
95			56,600	54,600	52,900		95		50,000 *	56,400	54,400	52,400	
100				51,300	49,600	47,800	100			52,900	50,900	49,100	
110					44,000	42,500	110				45,200	43,600	42,100
120							120				39,200	37,700	

90' Boom							90' Boom						
Load Radius (ft.)	90 ft Jib						Load Radius (ft.)	100 ft Jib					
	Boom Angle (deg.)							Boom Angle (deg.)					
	88	83	78	73	68	63		88	83	78	73	68	63
40	118,000 *						40	118,000 *					
45	118,000 *						45	118,000 *					
50	115,300 *						50	115,300 *					
55	99,800 *	111,900					55	100,100 *					
60	87,900 *	100,900					60	88,100 *	100,900				
65	78,400 *	92,200					65	78,400 *	92,200				
70	70,500 *	84,100 *	82,400				70	70,500 *	84,100				
75	63,700 *	76,200 *	75,600				75	63,900 *	76,200 *	75,100			
80	58,200 *	68,700 *	69,600				80	58,200 *	69,000 *	69,200			
85	53,300 *	62,400 *	64,600	62,600			85	53,300 *	62,600 *	64,100			
90	48,900 *	57,100 *	60,100	58,200			90	49,100 *	57,300 *	59,700	57,700		
95	43,600 *	52,400 *	56,200	54,400			95	45,400 *	52,400 *	55,700	54,000		
100		48,200 *	52,600	50,900	48,900		100	42,100 *	48,500 *	52,200	50,700		
110			46,500 *	45,200	43,400	42,100	110		41,600 *	46,500	44,900	42,900	
120				40,500	38,800	37,700	120			40,100 *	40,300	38,300	37,200
130					35,200	33,900	130				36,300	34,800	33,500
140							140						30,600



CK2500-II Luffing Jib Rating Loads in Pounds

15 Counterweights + 2 Low Weights

Refer to notes page 8

90' Boom							90' Boom						
Load Radius (ft.)	110 ft Jib						Load Radius (ft.)	120 ft Jib					
	Boom Angle (deg.)							Boom Angle (deg.)					
	88	83	78	73	68	63		88	83	78	73	68	63
45	113,700 *						45	88,500 *					
50	112,200 *						50	88,500 *					
55	101,600 *						55	88,500 *					
60	89,500 *	100,900					60	83,300 *					
65	79,800 *	92,200					65	78,700 *	84,600 *				
70	71,600 *	84,300					70	71,400 *	80,000 *				
75	65,000 *	76,700 *					75	64,800 *	75,800 *				
80	59,300 *	69,200 *	69,400				80	59,000 *	70,100 *				
85	54,400 *	62,800 *	64,300				85	54,200 *	63,700 *	63,900			
90	50,000 *	57,500 *	59,900				90	50,000 *	58,200 *	59,500			
95	46,300 *	52,900 *	56,000	53,800			95	46,300 *	53,500 *	55,500			
100	42,900 *	48,700 *	52,400	50,400			100	42,900 *	49,300 *	52,000	50,400		
110	37,200 *	42,100 *	46,500	44,700	42,900		110	37,200 *	42,500 *	46,300	44,700		
120		36,600 *	41,000 *	40,100	38,500		120	32,600 *	37,000 *	41,000 *	40,100	38,100	
130			35,900 *	36,300	34,800	33,500	130		32,600 *	35,700 *	36,100	34,300	33,200
140				33,000	31,700	30,400	140			31,500 *	32,800	31,300	30,200
150						27,700	150				30,200	28,600	27,700
160							160						25,300

90' Boom							90' Boom						
Load Radius (ft.)	130 ft Jib						Load Radius (ft.)	140 ft Jib					
	Boom Angle (deg.)							Boom Angle (deg.)					
	88	83	78	73	68	63		88	83	78	73	68	63
50	77,600 *						55	64,600 *					
55	73,400 *						60	60,600 *					
60	69,200 *						65	57,100 *					
65	65,200 *						70	54,000 *	57,100 *				
70	61,700 *	67,600 *					75	51,100 *	54,000 *				
75	58,600 *	63,900 *					80	48,700 *	51,100 *				
80	55,700 *	60,600 *					85	46,300 *	48,700 *				
85	53,300 *	57,700 *	62,600 *				90	44,000 *	46,300 *	52,000 *			
90	50,700 *	54,900 *	59,500				95	42,300 *	44,300 *	49,300 *			
95	46,900 *	52,400 *	55,500				100	40,300 *	42,300 *	46,900 *			
100	43,400 *	49,300 *	52,000				110	37,200 *	39,000 *	42,700 *	44,300		
110	37,900 *	42,500 *	46,300	44,300			120	33,000 *	35,900 *	39,400 *	39,600		
120	33,200 *	37,000 *	41,400	39,600	38,100		130	29,100 *	33,000 *	35,900 *	35,700	33,900	
130	29,300 *	32,600 *	36,300 *	35,900	34,300		140	25,700 *	29,300 *	31,700 *	32,600	30,800	
140		28,800 *	31,900 *	32,600	31,300	29,900	150		26,000 *	28,200 *	29,700	28,200	27,300
150			28,400 *	29,700	28,600	27,300	160			25,100 *	27,300	25,700	24,900
160				27,500	26,200	25,100	170				25,100	23,800	22,900
170						23,100	180						21,300
180							190						



CK2500-II Luffing Jib Rating Loads in Pounds

15 Counterweights + 2 Low Weights

Refer to notes page 8

90° Boom							90° Boom						
Load Radius (ft.)	150 ft Jib						Load Radius (ft.)	160 ft Jib					
	Boom Angle (deg.)							Boom Angle (deg.)					
	88	83	78	73	68	63		88	83	78	73	68	63
55	53,500 *						55						
60	50,200 *						60	43,400 *					
65	47,400 *						65	41,000 *					
70	44,900 *						70	38,500 *					
75	42,500 *	46,500 *					75	36,600 *					
80	40,300 *	44,000 *					80	34,600 *	37,900 *				
85	38,500 *	41,800 *					85	32,800 *	35,900 *				
90	36,600 *	39,600 *					90	31,300 *	33,900 *				
95	35,000 *	37,900 *	41,000 *				95	29,700 *	32,400 *				
100	33,500 *	36,100 *	39,000 *				100	28,400 *	30,800 *	33,200 *			
110	30,800 *	33,000 *	35,500 *				110	26,000 *	28,000 *	30,200 *			
120	28,400 *	30,400 *	32,600 *	35,000 *			120	24,000 *	25,700 *	27,500 *	29,700 *		
130	26,400 *	28,200 *	30,200 *	32,100 *			130	22,000 *	23,500 *	25,300 *	27,100 *		
140	24,600 *	26,200 *	28,000 *	29,700 *	31,000		140	20,500 *	21,800 *	23,300 *	24,900 *	26,600 *	
150	23,100 *	24,400 *	26,000 *	27,500 *	28,400	27,100	150	19,100 *	20,200 *	21,600 *	23,100 *	24,400 *	
160		23,100 *	24,400 *	25,700 *	26,000	24,900	160	17,800 *	18,900 *	20,000 *	21,300 *	22,700 *	24,000
170			23,100 *	24,200 *	24,000	22,900	170		17,800 *	18,700 *	20,000 *	21,100 *	22,200
180				22,700 *	22,200	21,100	180			17,800 *	18,700 *	19,800 *	20,700
190						19,600	190				17,600 *	18,500 *	19,100
200							200						17,800

90° Boom							90° Boom						
Load Radius (ft.)	170 ft Jib						Load Radius (ft.)	170 ft Jib					
	Boom Angle (deg.)							Boom Angle (deg.)					
	88	83	78	73	68	63		88	83	78	73	68	63
60	38,800 *												
65	36,600 *												
70	34,300 *												
75	32,400 *												
80	30,600 *												
85	29,100 *	31,700 *											
90	27,500 *	30,200 *											
95	26,200 *	28,600 *											
100	25,100 *	27,100 *											
110	22,700 *	24,600 *	26,600 *										
120	20,900 *	22,400 *	24,200 *										
130	19,100 *	20,500 *	22,000 *	23,800 *									
140	17,600 *	18,900 *	20,200 *	21,800 *									
150	16,300 *	17,400 *	18,700 *	20,000 *	21,300 *								
160	15,200 *	16,000 *	17,100 *	18,500 *	19,600 *								
170	14,100 *	14,900 *	16,000 *	17,100 *	18,000 *	19,400 *							
180		14,100 *	14,900 *	15,800 *	16,900 *	17,800 *							
190			14,100 *	14,700 *	15,600 *	16,500 *							
200					14,700 *	15,400 *							
210						14,500 *							



CK2500-II Luffing Jib Rating Loads in Pounds

15 Counterweights + 2 Low Weights

Refer to notes page 8

100' Boom							100' Boom						
Load Radius (ft.)	70 ft Jib						Load Radius (ft.)	80 ft Jib					
	Boom Angle (deg.)							Boom Angle (deg.)					
	88	83	78	73	68	63		88	83	78	73	68	63
35	118,000 *						35	118,000 *					
40	118,000 *						40	118,000 *					
45	118,000 *						45	118,000 *					
50	114,800 *	116,100					50	115,700 *	116,100				
55	99,400 *	112,100					55	100,300 *	112,100				
60	87,300 *	101,500					60	88,100 *	101,600				
65	77,600 *	92,700	90,400				65	78,200 *	92,900	89,900			
70	69,400 *	84,300 *	82,200				70	70,300 *	84,500	81,800			
75	61,900 *	76,000 *	75,400	72,500			75	63,500 *	76,600 *	74,900			
80		68,300 *	69,400	66,800			80	57,700 *	69,200 *	69,200	66,300		
85		61,700 *	64,300	61,900			85	51,800 *	62,600 *	64,100	61,500		
90			59,900	57,500	55,300		90		57,100 *	59,700	57,100		
95			56,000	53,800	51,500		95		52,000 *	55,700	53,300	51,100	
100				50,400	48,500		100			52,200	50,000	48,000	
110					42,900	41,200	110				44,500	42,500	40,700
120						37,000	120					38,100	36,600
130							130						33,000

100' Boom							100' Boom						
Load Radius (ft.)	90 ft Jib						Load Radius (ft.)	100 ft Jib					
	Boom Angle (deg.)							Boom Angle (deg.)					
	88	83	78	73	68	63		88	83	78	73	68	63
40	118,000 *						40	118,000 *					
45	118,000 *						45	118,000 *					
50	116,400 *						50	116,400 *					
55	100,700 *	112,100					55	100,900 *					
60	88,600 *	101,600					60	88,800 *	101,600				
65	78,900 *	92,900					65	78,900 *	92,900				
70	70,700 *	84,600	81,500				70	71,000 *	84,600				
75	64,100 *	77,400	74,700				75	64,100 *	77,400	74,300			
80	58,400 *	70,300 *	68,700				80	58,400 *	70,400 *	68,300			
85	53,500 *	63,900 *	63,700	61,500			85	53,500 *	63,900 *	63,500			
90	49,100 *	58,200 *	59,300	57,100			90	49,300 *	58,400 *	59,000	56,600		
95	44,300 *	53,300 *	55,500	53,300			95	45,600 *	53,500 *	55,100	52,900		
100		49,100 *	52,000	50,000	47,600		100	42,300 *	49,300 *	51,500	49,600		
110			46,300	44,500	42,300		110		42,300 *	45,800	44,000	41,800	
120				39,900	37,900	36,300	120			41,000	39,400	37,400	
130					34,100	32,800	130				35,700	33,700	32,400
140						29,900	140					30,800	29,500
150							150						27,100

CK2500-II Luffing Jib Rating Loads in Pounds

15 Counterweights + 2 Low Weights

Refer to notes page 8

100' Boom							100' Boom						
Load Radius (ft.)	110 ft Jib						Load Radius (ft.)	120 ft Jib					
	Boom Angle (deg.)							Boom Angle (deg.)					
	88	83	78	73	68	63		88	83	78	73	68	63
45	113,700 *						45	88,500 *					
50	112,200 *						50	88,500 *					
55	102,500 *						55	88,500 *					
60	90,100 *						60	83,500 *					
65	80,200 *	92,800					65	78,900 *	85,900 *				
70	72,100 *	84,800					70	71,800 *	81,100 *				
75	65,200 *	77,600					75	65,200 *	76,700 *				
80	59,500 *	70,700 *	68,500				80	59,300 *	71,600 *				
85	54,600 *	64,100 *	63,500				85	54,400 *	65,000 *	63,200			
90	50,200 *	58,600 *	59,000				90	50,000 *	59,500 *	58,800			
95	46,500 *	53,800 *	55,300	52,900			95	46,300 *	54,600 *	54,900			
100	43,200 *	49,600 *	51,800	49,600			100	42,900 *	50,200 *	51,300	49,300		
110	37,400 *	42,700 *	46,000	43,800			110	37,400 *	43,200 *	45,600	43,800		
120		37,000 *	41,200	39,400	37,700		120	32,800 *	37,700 *	40,700	39,200	37,000	
130			36,800 *	35,500	33,900	32,400	130		33,000 *	36,600 *	35,500	33,500	
140				32,400	30,800	29,300	140			32,100 *	32,100	30,400	29,300
150					28,200	26,900	150				29,500	27,700	26,600
160						24,600	160					25,500	24,400
170							170						22,700

100' Boom							100' Boom						
Load Radius (ft.)	130 ft Jib						Load Radius (ft.)	140 ft Jib					
	Boom Angle (deg.)							Boom Angle (deg.)					
	88	83	78	73	68	63		88	83	78	73	68	63
50	77,600 *						50						
55	73,800 *						55	64,600 *					
60	69,400 *						60	60,800 *					
65	65,400 *						65	57,300 *					
70	61,900 *	68,500 *					70	54,200 *					
75	58,800 *	64,800 *					75	51,300 *	54,600 *				
80	56,000 *	61,500 *					80	48,700 *	51,800 *				
85	53,300 *	58,400 *					85	46,500 *	49,100 *				
90	50,900 *	55,500 *	58,800				90	44,300 *	46,900 *				
95	46,900 *	53,100 *	54,900				95	42,300 *	44,700 *	50,200 *			
100	43,600 *	50,200 *	51,500				100	40,500 *	42,700 *	47,800 *			
110	37,900 *	43,200 *	45,600	43,600			110	37,200 *	39,200 *	43,600 *			
120	33,200 *	37,700 *	40,700	39,000			120	33,000 *	36,300 *	39,900 *	39,000		
130	29,300 *	33,000 *	37,000	35,200	33,500		130	29,300 *	33,700 *	36,600 *	35,000	33,000	
140		29,300 *	32,800 *	31,900	30,400	28,800	140	26,000 *	29,700 *	32,600 *	31,900	29,900	
150			29,100 *	29,300	27,700	26,400	150		26,400 *	28,800 *	29,100	27,300	26,200
160				26,900	25,500	24,200	160			25,700 *	26,600	25,100	24,000
170					23,500	22,200	170				24,600	23,100	22,200
180						20,700	180					21,300	20,500
190							190						18,900

CK2500-II Luffing Jib Rating Loads in Pounds

15 Counterweights + 2 Low Weights

Refer to notes page 8

100' Boom							100' Boom						
Load Radius (ft.)	150 ft Jib						Load Radius (ft.)	160 ft Jib					
	Boom Angle (deg.)							Boom Angle (deg.)					
	88	83	78	73	68	63		88	83	78	73	68	63
55	53,500 *						55						
60	50,400 *						60	43,600 *					
65	47,600 *						65	41,000 *					
70	44,900 *						70	38,800 *					
75	42,700 *	47,100 *					75	36,600 *					
80	40,500 *	44,500 *					80	34,800 *	38,300 *				
85	38,500 *	42,300 *					85	33,000 *	36,300 *				
90	36,800 *	40,100 *					90	31,300 *	34,300 *				
95	35,000 *	38,300 *					95	29,900 *	32,600 *				
100	33,500 *	36,600 *	39,600 *				100	28,400 *	31,000 *	33,900 *			
110	30,800 *	33,500 *	36,100 *				110	26,000 *	28,400 *	30,800 *			
120	28,600 *	30,600 *	33,000 *	35,900 *			120	24,000 *	26,000 *	28,200 *			
130	26,400 *	28,400 *	30,600 *	32,800 *			130	22,000 *	23,800 *	25,700 *	27,700 *		
140	24,600 *	26,400 *	28,200 *	30,400 *	30,200		140	20,500 *	22,000 *	23,800 *	25,500 *		
150	23,300 *	24,600 *	26,400 *	28,200 *	27,500		150	19,100 *	20,500 *	22,000 *	23,500 *	25,300 *	
160		23,300 *	24,600 *	26,200 *	25,300	24,000	160	17,800 *	19,100 *	20,500 *	21,800 *	23,300 *	23,500
170			23,300 *	24,600	23,300	22,000	170		17,800 *	18,900 *	20,200 *	21,600 *	21,600
180				22,700	21,600	20,200	180			17,800 *	18,900 *	20,200 *	20,000
190					20,000	18,900	190				17,800 *	18,900 *	18,500
200							200					17,800 *	17,100

100' Boom													
Load Radius (ft.)	170 ft Jib												
	Boom Angle (deg.)												
	88	83	78	73	68	63							
60	39,000 *												
65	36,600 *												
70	34,300 *												
75	32,600 *												
80	30,800 *												
85	29,100 *	32,100 *											
90	27,700 *	30,400 *											
95	26,200 *	28,800 *											
100	25,100 *	27,500 *											
110	22,900 *	24,900 *	27,100 *										
120	20,900 *	22,700 *	24,600 *										
130	19,100 *	20,700 *	22,400 *	24,400 *									
140	17,600 *	19,100 *	20,700 *	22,200 *									
150	16,300 *	17,600 *	18,900 *	20,500 *	22,000 *								
160	15,200 *	16,300 *	17,600 *	18,900 *	20,200 *								
170	14,100 *	15,200 *	16,300 *	17,400 *	18,700 *	20,000 *							
180		14,100 *	15,200 *	16,000 *	17,400 *	18,500 *							
190			14,100 *	15,200 *	16,000 *	17,100 *							
200				14,100 *	14,900 *	15,800 *							
210					14,100 *	14,900 *							

CK2500-II Luffing Jib Rating Loads in Pounds

15 Counterweights + 2 Low Weights

Refer to notes page 8

110' Boom							110' Boom						
Load Radius (ft.)	70 ft Jib						Load Radius (ft.)	80 ft Jib					
	Boom Angle (deg.)							Boom Angle (deg.)					
	88	83	78	73	68	63		88	83	78	73	68	63
35	118,000 *						35	118,000 *					
40	118,000 *						40	118,000 *					
45	118,000 *						45	118,000 *					
50	115,900 *	116,000					50	116,800 *					
55	100,300 *	111,700					55	100,900 *	111,700				
60	87,900 *	100,900					60	88,800 *	101,100				
65	78,000 *	92,100	89,500				65	78,900 *	92,300				
70	69,800 *	84,200	81,300				70	70,700 *	84,600	80,900			
75	62,800 *	76,800	74,500				75	63,900 *	77,400	74,300			
80	51,300 *	69,800 *	68,700	65,700			80	57,900 *	70,800 *	68,300			
85		63,000 *	63,700	60,800			85	52,400 *	64,600 *	63,200	60,800		
90		53,300 *	59,300	56,600			90		58,800 *	59,000	56,600		
95			55,300	52,900	50,700		95		53,800 *	55,100	52,900		
100				49,600	47,400		100			51,500	49,600	46,900	
110					42,100	40,100	110				44,000	41,600	
120						35,900	120					37,200	35,700
130							130						32,100

110' Boom							110' Boom						
Load Radius (ft.)	90 ft Jib						Load Radius (ft.)	100 ft Jib					
	Boom Angle (deg.)							Boom Angle (deg.)					
	88	83	78	73	68	63		88	83	78	73	68	63
40	118,000 *						40	118,000 *					
45	118,000 *						45	118,000 *					
50	117,500 *						50	117,500 *					
55	101,600 *	111,700					55	101,800 *					
60	89,300 *	101,100					60	89,300 *	100,900				
65	79,300 *	92,300					65	79,300 *	92,100				
70	71,200 *	84,600					70	71,400 *	84,400				
75	64,300 *	77,600	73,800				75	64,600 *	77,300				
80	58,600 *	71,200	68,100				80	58,800 *	71,200	67,600			
85	53,800 *	65,200 *	63,000				85	53,800 *	65,200 *	62,600			
90	49,300 *	59,500 *	58,600	56,200			90	49,600 *	59,500 *	58,200			
95	44,700 *	54,400 *	54,900	52,600			95	45,600 *	54,600 *	54,400	52,200		
100		50,000 *	51,300	49,300			100	42,300 *	50,200 *	51,100	48,900		
110			45,600	43,600	41,400		110		42,900 *	45,200	43,400	40,700	
120				39,200	37,000	35,500	120			40,500	38,800	36,600	
130					33,500	31,900	130				35,000	33,000	31,500
140						29,100	140					29,900	28,600
150							150						26,200

CK2500-II Luffing Jib Rating Loads in Pounds

15 Counterweights + 2 Low Weights

Refer to notes page 8

110' Boom							110' Boom						
Load Radius (ft.)	110 ft Jib						Load Radius (ft.)	120 ft Jib					
	Boom Angle (deg.)							Boom Angle (deg.)					
	88	83	78	73	68	63		88	83	78	73	68	63
45	112,000 *						45						
50	111,100 *						50	88,500 *					
55	103,400 *						55	88,500 *					
60	90,800 *						60	83,700 *					
65	80,700 *	92,300					65	79,100 *					
70	72,500 *	84,200					70	72,300 *	83,700				
75	65,700 *	77,100					75	65,400 *	76,700				
80	59,700 *	71,200	67,900				80	59,700 *	70,500 *				
85	54,900 *	65,700 *	62,800				85	54,600 *	65,400 *	62,400			
90	50,400 *	59,700 *	58,400				90	50,200 *	59,700 *	57,900			
95	46,700 *	54,900 *	54,600				95	46,500 *	54,600 *	54,200			
100	43,200 *	50,400 *	51,100	48,700			100	43,200 *	50,400 *	50,900			
110	37,400 *	43,400 *	45,400	43,200			110	37,400 *	43,200 *	44,900	42,700		
120		37,700 *	40,700	38,800	36,800		120	32,800 *	37,700 *	40,300	38,300		
130			36,800	35,000	33,000		130		32,800 *	36,300	34,600	32,600	
140				31,700	30,200	28,400	140			33,000	31,300	29,700	28,000
150					27,500	26,000	150				28,600	27,100	25,500
160						24,000	160					24,900	23,500
170							170						21,600

110' Boom							110' Boom						
Load Radius (ft.)	130 ft Jib						Load Radius (ft.)	140 ft Jib					
	Boom Angle (deg.)							Boom Angle (deg.)					
	88	83	78	73	68	63		88	83	78	73	68	63
50	77,600 *						50						
55	74,000 *						55	64,600 *					
60	69,600 *						60	61,000 *					
65	65,700 *						65	57,500 *					
70	62,100 *	69,400 *					70	54,200 *					
75	59,000 *	65,700 *					75	51,300 *	55,300 *				
80	56,200 *	62,100 *					80	48,900 *	52,400 *				
85	53,500 *	59,000 *					85	46,500 *	49,800 *				
90	51,100 *	56,200 *	58,200				90	44,300 *	47,400 *				
95	47,100 *	53,500 *	54,200				95	42,300 *	45,200 *	51,300 *			
100	43,800 *	51,100 *	50,900				100	40,500 *	43,200 *	48,700 *			
110	38,100 *	43,800 *	45,200	42,700			110	37,200 *	39,600 *	44,300 *			
120	33,200 *	38,100 *	40,300	38,300			120	33,000 *	36,600 *	39,900	38,100		
130	29,500 *	33,500 *	36,300	34,600	32,600		130	29,300 *	33,900 *	36,100	34,300		
140		29,500 *	33,000	31,300	29,700		140	26,000 *	30,200 *	32,800	31,300	29,300	
150			29,700 *	28,600	27,100	25,500	150		26,600 *	29,500 *	28,600	26,600	
160				26,400	24,900	23,300	160			26,200 *	26,200	24,400	23,300
170					22,900	21,600	170				24,200	22,400	21,300
180						20,000	180					20,900	19,800
190							190						18,300

CK2500-II Luffing Jib Rating Loads in Pounds

15 Counterweights + 2 Low Weights

Refer to notes page 8

110° Boom							110° Boom						
Load Radius (ft.)	150 ft Jib						Load Radius (ft.)	160 ft Jib					
	Boom Angle (deg.)							Boom Angle (deg.)					
	88	83	78	73	68	63		88	83	78	73	68	63
55	53,800 *						55						
60	50,700 *						60	43,800 *					
65	47,800 *						65	41,200 *					
70	45,200 *						70	38,800 *					
75	42,700 *						75	36,800 *					
80	40,500 *	45,200 *					80	34,800 *	38,800 *				
85	38,500 *	42,700 *					85	33,000 *	36,800 *				
90	36,800 *	40,500 *					90	31,500 *	34,800 *				
95	35,200 *	38,500 *					95	29,900 *	33,000 *				
100	33,700 *	36,800 *	40,500 *				100	28,600 *	31,500 *				
110	30,800 *	33,700 *	36,800 *				110	26,200 *	28,600 *	31,500 *			
120	28,600 *	31,000 *	33,700 *	36,800 *			120	24,000 *	26,200 *	28,600 *			
130	26,400 *	28,600 *	31,000 *	33,700 *			130	22,200 *	24,000 *	26,200 *	28,400 *		
140	24,600 *	26,600 *	28,600 *	31,000 *	29,500		140	20,500 *	22,200 *	24,000 *	26,200 *		
150	23,300 *	24,900 *	26,600 *	28,400	26,900		150	19,100 *	20,700 *	22,200 *	24,000 *	26,000 *	
160		23,300 *	24,900 *	26,200	24,600	23,100	160	17,800 *	19,100 *	20,700 *	22,200 *	24,000 *	
170			23,500 *	24,000	22,700	21,300	170		18,000 *	19,400 *	20,700 *	22,200	20,900
180				22,200	20,900	19,600	180			18,000 *	19,400 *	20,500	19,100
190					19,400	18,300	190				18,000 *	19,100	17,800
200						16,900	200					17,600	16,500
210							210						15,400

110° Boom						
Load Radius (ft.)	170 ft Jib					
	Boom Angle (deg.)					
	88	83	78	73	68	63
60	39,000 *					
65	36,800 *					
70	34,600 *					
75	32,600 *					
80	30,800 *					
85	29,300 *	32,600 *				
90	27,700 *	30,800 *				
95	26,400 *	29,300 *				
100	25,100 *	27,700 *				
110	22,900 *	25,100 *	27,700 *			
120	20,900 *	22,900 *	25,100 *			
130	19,100 *	20,900 *	22,900 *	25,100 *		
140	17,600 *	19,100 *	20,900 *	22,900 *		
150	16,300 *	17,600 *	19,100 *	20,900 *	22,700 *	
160	15,200 *	16,300 *	17,800 *	19,100 *	20,900 *	
170	14,100 *	15,200 *	16,500 *	17,800 *	19,100 *	
180		14,300 *	15,400 *	16,500 *	17,800 *	18,900
190			14,300 *	15,400 *	16,500 *	17,600
200				14,300 *	15,400 *	16,300
210					14,300 *	14,900
220						13,800



CK2500-II Luffing Jib Rating Loads in Pounds

15 Counterweights + 2 Low Weights

Refer to notes page 8

120' Boom							120' Boom						
Load Radius (ft.)	70 ft Jib						Load Radius (ft.)	80 ft Jib					
	Boom Angle (deg.)							Boom Angle (deg.)					
	88	83	78	73	68	63		88	83	78	73	68	63
35	118,000 *						35						
40	118,000 *						40	118,000 *					
45	118,000 *						45	118,000 *					
50	117,000 *	115,400					50	118,000 *					
55	100,900 *	111,200					55	101,800 *	111,200				
60	88,600 *	100,500					60	89,500 *	100,600				
65	78,400 *	92,000	88,400				65	79,300 *	92,100				
70	70,300 *	84,300	80,400				70	71,200 *	84,400				
75	63,200 *	77,300	73,600				75	64,100 *	77,300				
80	52,200 *	71,400	67,900				80	58,400 *	71,400				
85		64,600 *	62,800	59,700			85	53,100 *	66,100	62,600			
90		56,600 *	58,600	55,500			90	44,300 *	60,100 *	58,200	55,500		
95			54,600	52,000			95		54,900 *	54,400	51,800		
100			51,300	48,700	46,300		100		48,500 *	50,900	48,500		
110				43,200	41,000	38,800	110			45,200	43,200	40,500	
120					36,600	34,600	120				38,500	36,100	34,300
130						31,300	130					32,800	31,000
140							140						28,200

120' Boom							120' Boom						
Load Radius (ft.)	90 ft Jib						Load Radius (ft.)	100 ft Jib					
	Boom Angle (deg.)							Boom Angle (deg.)					
	88	83	78	73	68	63		88	83	78	73	68	63
40	118,000 *						40						
45	118,000 *						45	118,000 *					
50	118,000 *						50	118,000 *					
55	102,500 *						55	102,500 *					
60	89,900 *	100,000					60	89,900 *	100,000				
65	79,800 *	92,100					65	80,000 *	91,800				
70	71,600 *	84,200					70	71,600 *	83,700				
75	64,800 *	77,100	72,900				75	64,800 *	76,700				
80	58,800 *	71,200	67,200				80	59,000 *	70,700	66,800			
85	53,800 *	65,900	62,100				85	54,000 *	65,700	61,700			
90	49,600 *	60,600 *	57,900				90	49,600 *	60,800 *	57,500			
95	45,400 *	55,500 *	54,200	51,500			95	45,800 *	55,500 *	53,800			
100		50,900 *	50,700	48,200			100	42,500 *	51,100 *	50,200	47,800		
110		41,800 *	44,900	42,700	40,100		110		43,600 *	44,500	42,300		
120			40,300	38,300	35,900		120		36,300 *	39,900	37,900	35,500	
130				34,600	32,400	30,800	130			36,100	34,300	31,900	30,400
140					29,500	28,000	140				31,000	29,100	27,500
150						25,500	150					26,600	25,100
160							160						23,100

CK2500-II Luffing Jib Rating Loads in Pounds

15 Counterweights + 2 Low Weights

Refer to notes page 8

120' Boom							120' Boom						
Load Radius (ft.)	110 ft Jib						Load Radius (ft.)	120 ft Jib					
	Boom Angle (deg.)							Boom Angle (deg.)					
	88	83	78	73	68	63		88	83	78	73	68	63
45	108,500 *						45						
50	107,600 *						50	88,500 *					
55	104,200 *						55	88,500 *					
60	91,500 *						60	84,200 *					
65	81,300 *	91,700					65	79,300 *					
70	72,900 *	83,700					70	72,700 *	83,100 *				
75	65,900 *	76,700					75	65,900 *	76,700				
80	60,100 *	70,700					80	59,900 *	70,700				
85	55,100 *	65,400	61,900				85	54,900 *	65,400				
90	50,700 *	61,000	57,700				90	50,400 *	60,800	57,300			
95	46,700 *	56,000 *	54,000				95	46,700 *	56,600 *	53,500			
100	43,400 *	51,300 *	50,400				100	43,200 *	52,200 *	50,000			
110	37,700 *	44,000 *	44,700	42,300			110	37,400 *	44,700 *	44,300	42,100		
120		38,100 *	40,100	37,900	35,700		120	32,800 *	38,800 *	39,600	37,700		
130			36,300	34,100	32,100		130		33,900 *	35,900	34,100	31,700	
140			33,000	31,000	29,100	27,300	140			32,600	30,800	28,600	
150				28,400	26,600	24,900	150			29,700 *	28,200	26,200	24,900
160					24,400	22,900	160				26,000	24,000	22,700
170						21,100	170					22,200	20,900

120' Boom							120' Boom						
Load Radius (ft.)	130 ft Jib						Load Radius (ft.)	140 ft Jib					
	Boom Angle (deg.)							Boom Angle (deg.)					
	88	83	78	73	68	63		88	83	78	73	68	63
50	77,600 *						50						
55	74,300 *						55	64,800 *					
60	69,800 *						60	61,200 *					
65	65,900 *						65	57,700 *					
70	62,400 *	70,500 *					70	54,400 *					
75	59,000 *	66,500 *					75	51,500 *	56,000 *				
80	56,200 *	62,800 *					80	48,900 *	53,100 *				
85	53,500 *	59,700 *					85	46,500 *	50,200 *				
90	51,100 *	56,800 *					90	44,500 *	47,800 *				
95	47,400 *	54,200 *	53,500				95	42,500 *	45,600 *	52,400 *			
100	43,800 *	51,800 *	50,200				100	40,500 *	43,600 *	49,800			
110	38,100 *	44,500 *	44,500				110	37,400 *	39,900 *	44,000			
120	33,500 *	38,800 *	39,900	37,400			120	33,200 *	36,800 *	39,400	37,400		
130	29,500 *	33,900 *	35,900	33,700			130	29,300 *	34,100 *	35,500	33,700		
140		29,900 *	32,600	30,600	28,600		140	26,000 *	30,600 *	32,100	30,600	28,200	
150			29,900	28,000	26,200	24,400	150		27,100 *	29,500	28,000	25,700	
160				25,700	24,000	22,400	160			26,900 *	25,500	23,500	22,200
170					22,200	20,700	170				23,500	21,800	20,500
180						19,100	180					20,000	18,900
190							190						17,600

CK2500-II Luffing Jib Rating Loads in Pounds

15 Counterweights + 2 Low Weights

Refer to notes page 8

120° Boom							120° Boom						
Load Radius (ft.)	150 ft Jib						Load Radius (ft.)	160 ft Jib					
	Boom Angle (deg.)							Boom Angle (deg.)					
	88	83	78	73	68	63		88	83	78	73	68	63
55	54,000 *						55						
60	50,700 *						60	43,800 *					
65	47,800 *						65	41,200 *					
70	45,200 *						70	39,000 *					
75	42,900 *						75	36,800 *					
80	40,700 *	45,600 *					80	34,800 *					
85	38,800 *	43,200 *					85	33,000 *	37,200 *				
90	37,000 *	41,000 *					90	31,500 *	35,200 *				
95	35,200 *	39,000 *					95	29,900 *	33,500 *				
100	33,700 *	37,200 *	41,400 *				100	28,600 *	31,700 *				
110	31,000 *	33,900 *	37,400 *				110	26,200 *	28,800 *	31,900 *			
120	28,600 *	31,300 *	34,300 *				120	24,000 *	26,400 *	29,100 *			
130	26,600 *	28,800 *	31,500 *	33,500			130	22,200 *	24,200 *	26,600 *	29,300 *		
140	24,600 *	26,900 *	29,100 *	30,400			140	20,500 *	22,400 *	24,400 *	26,600 *		
150	23,300 *	25,100 *	27,100 *	27,700	26,000		150	19,100 *	20,700 *	22,700 *	24,600 *	25,500	
160		23,500 *	25,300 *	25,500	23,800		160	17,800 *	19,400 *	20,900 *	22,700 *	23,300	
170			23,800 *	23,500	21,800	20,500	170		18,000 *	19,600 *	21,100 *	21,600	20,000
180				21,800	20,200	18,700	180			18,300 *	19,600 *	19,800	18,300
190					18,700	17,400	190				18,500 *	18,300	16,900
200						16,000	200					16,900	15,600
210							210						14,300

120° Boom							120° Boom						
Load Radius (ft.)	170 ft Jib						Load Radius (ft.)	170 ft Jib					
	Boom Angle (deg.)							Boom Angle (deg.)					
	88	83	78	73	68	63		88	83	78	73	68	63
60	39,200 *												
65	36,800 *												
70	34,600 *												
75	32,600 *												
80	30,800 *												
85	29,300 *	33,000 *											
90	27,700 *	31,300 *											
95	26,400 *	29,500 *											
100	25,100 *	28,000 *											
110	22,900 *	25,300 *	28,200 *										
120	20,900 *	23,100 *	25,500 *										
130	19,100 *	21,100 *	23,300 *										
140	17,600 *	19,400 *	21,300 *	23,300 *									
150	16,300 *	17,800 *	19,600 *	21,300 *									
160	15,200 *	16,500 *	18,000 *	19,600 *	21,600 *								
170	14,100 *	15,400 *	16,700 *	18,000 *	19,800 *								
180		14,300 *	15,400 *	16,700 *	18,300 *	18,000							
190			14,500 *	15,600 *	16,900 *	16,500							
200				14,500 *	15,600 *	15,200							
210					14,700 *	13,800							
220						13,000							



CK2500-II Luffing Jib Rating Loads in Pounds

15 Counterweights + 2 Low Weights

Refer to notes page 8

130' Boom							130' Boom						
Load Radius (ft.)	70 ft Jib						Load Radius (ft.)	80 ft Jib					
	Boom Angle (deg.)							Boom Angle (deg.)					
	88	83	78	73	68	63		88	83	78	73	68	63
40	118,000 *						40	118,000 *					
45	118,000 *						45	118,000 *					
50	118,000 *						50	118,000 *					
55	101,800 *	110,800					55	102,700 *	110,800				
60	89,300 *	100,300					60	90,100 *	100,300				
65	79,100 *	91,900					65	79,800 *	91,900				
70	70,700 *	83,700	79,300				70	71,600 *	83,700				
75	63,700 *	76,900	72,700				75	64,600 *	76,900	72,300			
80	53,300 *	70,700	67,000				80	58,600 *	70,700	66,500			
85		65,700	62,100	58,600			85	53,300 *	65,700	61,700			
90		59,500 *	57,700	54,400			90	45,200 *	61,000	57,300	54,400		
95			54,000	50,900			95		56,000 *	53,500	50,700		
100			50,700	47,800	44,900		100		50,900 *	50,200	47,600		
110				42,300	39,900		110			44,500	42,300	39,200	
120					35,700	33,500	120				37,900	35,200	
130						30,200	130					31,700	29,900
140							140						27,100

130' Boom							130' Boom						
Load Radius (ft.)	90 ft Jib						Load Radius (ft.)	100 ft Jib					
	Boom Angle (deg.)							Boom Angle (deg.)					
	88	83	78	73	68	63		88	83	78	73	68	63
40	118,000 *						40	118,000 *					
45	118,000 *						45	118,000 *					
50	118,000 *						50	118,000 *					
55	103,400 *						55	103,400 *					
60	90,600 *	100,100					60	90,800 *					
65	80,400 *	91,700					65	80,400 *	91,200				
70	72,100 *	83,500					70	72,100 *	83,300				
75	65,000 *	76,700					75	65,200 *	76,200				
80	59,300 *	70,500	66,300				80	59,300 *	70,300	65,900			
85	54,000 *	65,400	61,500				85	54,200 *	65,000	61,000			
90	49,600 *	60,800	57,100				90	49,800 *	60,600	56,600			
95	45,800 *	56,600 *	53,300	50,400			95	46,000 *	56,600	52,900			
100	38,800 *	51,800 *	50,000	47,400			100	42,500 *	52,000 *	49,600	46,900		
110		43,600 *	44,300	41,800			110		44,300 *	43,800	41,400		
120			39,600	37,400	34,800		120		37,900 *	39,400	37,000	34,300	
130				33,900	31,500	29,500	130			35,500	33,500	30,800	
140					28,600	26,900	140				30,400	28,000	26,400
150						24,400	150					25,500	24,000
160							160						22,000



CK2500-II Luffing Jib Rating Loads in Pounds

15 Counterweights + 2 Low Weights

Refer to notes page 8

130' Boom							130' Boom						
Load Radius (ft.)	110 ft Jib						Load Radius (ft.)	120 ft Jib					
	Boom Angle (deg.)							Boom Angle (deg.)					
	88	83	78	73	68	63		88	83	78	73	68	63
45	104,500 *						45						
50	103,800 *						50	88,500 *					
55	102,700 *						55	88,500 *					
60	92,300 *						60	84,400 *					
65	81,800 *	91,000					65	79,600 *					
70	73,400 *	83,100					70	73,200 *	82,600				
75	66,300 *	76,000					75	66,100 *	76,000				
80	60,400 *	70,100					80	60,100 *	70,100				
85	55,300 *	65,000	61,200				85	55,100 *	65,000				
90	50,900 *	60,400	56,800				90	50,700 *	60,400	56,400			
95	46,900 *	56,400	53,100				95	46,700 *	56,400	52,600			
100	43,400 *	52,400 *	49,800				100	43,400 *	52,900	49,300			
110	37,700 *	44,700 *	44,000	41,400			110	37,700 *	45,400 *	43,600	41,200		
120		38,800 *	39,400	37,000			120	32,800 *	39,400 *	39,200	36,800		
130		33,200 *	35,700	33,200	31,000		130		34,300 *	35,200	33,200	30,600	
140			32,600	30,400	28,200		140		29,700 *	32,100	30,200	27,700	
150				27,700	25,700	24,000	150			29,300	27,500	25,300	23,800
160					23,800	22,000	160				25,300	23,100	21,800
170						20,200	170					21,300	20,000
180							180						18,500

130' Boom							130' Boom						
Load Radius (ft.)	130 ft Jib						Load Radius (ft.)	140 ft Jib					
	Boom Angle (deg.)							Boom Angle (deg.)					
	88	83	78	73	68	63		88	83	78	73	68	63
50	77,600 *						50						
55	74,500 *						55	64,800 *					
60	70,100 *						60	61,500 *					
65	66,100 *						65	57,900 *					
70	62,600 *						70	54,600 *					
75	59,300 *	67,400 *					75	51,800 *	56,600 *				
80	56,400 *	63,700 *					80	49,100 *	53,800 *				
85	53,800 *	60,400 *					85	46,700 *	50,900 *				
90	51,300 *	57,300 *					90	44,500 *	48,500 *				
95	47,600 *	54,600 *	52,900				95	42,500 *	46,000 *				
100	44,000 *	52,200 *	49,300				100	40,700 *	44,000 *	49,100			
110	38,300 *	45,400 *	43,800				110	37,400 *	40,300 *	43,400			
120	33,500 *	39,200 *	39,200	36,600			120	33,200 *	37,200 *	38,800	36,600		
130	29,500 *	34,300 *	35,500	33,000			130	29,300 *	34,600 *	35,000	32,800		
140		30,400 *	32,100	29,900	27,700		140	26,000 *	30,800 *	31,700	29,900	27,300	
150		26,400 *	29,300	27,300	25,300		150		27,500 *	29,100	27,300	24,900	
160			27,100	25,100	23,100	21,300	160			26,600	25,100	22,700	21,300
170				23,100	21,300	19,600	170			24,400 *	23,100	20,900	19,600
180					19,800	18,300	180				21,300	19,400	18,000
190						16,700	190					17,800	16,500
200							200						15,200



CK2500-II Luffing Jib Rating Loads in Pounds

15 Counterweights + 2 Low Weights

Refer to notes page 8

130' Boom							130' Boom						
Load Radius (ft.)	150 ft Jib						Load Radius (ft.)	160 ft Jib					
	Boom Angle (deg.)							Boom Angle (deg.)					
	88	83	78	73	68	63		88	83	78	73	68	63
55	54,200 *						55						
60	50,900 *						60	44,000 *					
65	48,000 *						65	41,400 *					
70	45,400 *						70	39,000 *					
75	42,900 *						75	37,000 *					
80	40,700 *	46,300 *					80	35,000 *					
85	38,800 *	43,800 *					85	33,200 *	37,700 *				
90	37,000 *	41,600 *					90	31,500 *	35,700 *				
95	35,200 *	39,400 *					95	29,900 *	33,700 *				
100	33,700 *	37,700 *					100	28,600 *	32,100 *				
110	31,000 *	34,300 *	38,100 *				110	26,200 *	29,100 *	32,600 *			
120	28,600 *	31,500 *	34,800 *				120	24,000 *	26,600 *	29,500 *			
130	26,600 *	29,100 *	31,900 *	32,800			130	22,200 *	24,400 *	27,100 *	29,900 *		
140	24,900 *	27,100 *	29,500 *	29,700			140	20,500 *	22,400 *	24,900 *	27,300 *		
150	23,300 *	25,100 *	27,300 *	27,100	25,100		150	19,100 *	20,900 *	22,900 *	25,100 *		
160		23,500 *	25,500 *	24,900	22,900		160	17,800 *	19,400 *	21,100 *	23,100 *	22,400	
170			24,000 *	22,900	21,100	19,400	170		18,300 *	19,800 *	21,600 *	20,700	
180			22,400 *	21,100	19,600	17,800	180			18,500 *	20,000 *	19,100	17,400
190				19,600	18,000	16,500	190			17,400 *	18,700 *	17,600	15,800
200					16,700	15,200	200				17,600 *	16,300	14,500
210						13,800	210					15,200	13,400
220							220						12,300

130' Boom													
Load Radius (ft.)	170 ft Jib												
	Boom Angle (deg.)												
	88	83	78	73	68	63							
60	39,400 *												
65	37,000 *												
70	34,800 *												
75	32,800 *												
80	31,000 *												
85	29,300 *	33,500 *											
90	27,700 *	31,500 *											
95	26,400 *	29,900 *											
100	25,100 *	28,400 *											
110	22,900 *	25,500 *	28,800 *										
120	20,900 *	23,300 *	26,000 *										
130	19,100 *	21,300 *	23,800 *										
140	17,600 *	19,600 *	21,600 *	24,000 *									
150	16,300 *	18,000 *	19,800 *	22,000 *									
160	15,200 *	16,700 *	18,300 *	20,000 *	22,200 *								
170	14,100 *	15,400 *	16,900 *	18,500 *	20,200 *								
180		14,300 *	15,600 *	17,100 *	18,700	16,900							
190			14,500 *	15,800 *	17,400	15,400							
200			13,600 *	14,700 *	16,000	14,100							
210				13,800 *	14,700	13,000							
220					13,600	11,900							
230						11,000							

CK2500-II Luffing Jib Rating Loads in Pounds

15 Counterweights + 2 Low Weights

Refer to notes page 8

140' Boom							140' Boom						
Load Radius (ft.)	70 ft Jib						Load Radius (ft.)	80 ft Jib					
	Boom Angle (deg.)							Boom Angle (deg.)					
	88	83	78	73	68	63		88	83	78	73	68	63
40	118,000 *						40	118,000 *					
45	118,000 *						45	118,000 *					
50	118,000 *						50	118,000 *					
55	102,700 *	110,200					55	103,600 *	110,200				
60	89,900 *	100,100					60	90,800 *	100,000				
65	79,600 *	91,700					65	80,400 *	91,500				
70	71,200 *	83,500	78,200				70	72,100 *	83,300				
75	63,900 *	76,700	71,600				75	64,800 *	76,200	71,200			
80	54,200 *	70,700	66,100				80	58,800 *	70,300	65,700			
85		65,400	61,200				85	53,500 *	65,200	60,800			
90		60,800	56,800	53,500			90	45,800 *	60,600	56,600			
95			53,100	50,000			95		56,600	52,900	49,600		
100			49,800	46,900			100		52,200 *	49,600	46,500		
110				41,600	38,500		110			43,800	41,200	38,100	
120					34,300	32,400	120				37,000	33,900	
130						29,100	130					30,600	28,600
140						26,400	140						26,000
150							150						23,800

140' Boom							140' Boom						
Load Radius (ft.)	90 ft Jib						Load Radius (ft.)	100 ft Jib					
	Boom Angle (deg.)							Boom Angle (deg.)					
	88	83	78	73	68	63		88	83	78	73	68	63
40	118,000 *						40	114,700 *					
45	118,000 *						45	114,700 *					
50	118,000 *						50	114,000 *					
55	104,200 *						55	104,500 *					
60	91,200 *	100,900					60	91,500 *					
65	80,900 *	91,200					65	81,100 *	90,600				
70	72,500 *	83,100					70	72,500 *	82,600				
75	65,400 *	76,000					75	65,400 *	75,600				
80	59,500 *	70,100	65,200				80	59,500 *	69,600				
85	54,200 *	65,000	60,600				85	54,400 *	64,600	59,900			
90	49,800 *	60,400	56,200				90	50,000 *	60,100	55,700			
95	45,800 *	56,400	52,400				95	46,000 *	56,200	52,000			
100	39,400 *	52,900 *	49,100	46,300			100	42,700 *	52,600	48,700			
110		44,700 *	43,600	41,000			110	34,100 *	45,200 *	43,200	40,500		
120			39,000	36,600	33,700		120		38,800 *	38,800	36,100		
130				33,000	30,400		130			35,000	32,600	29,700	
140					27,500	25,500	140				29,700	27,100	25,100
150						23,300	150					24,600	22,900
160							160						20,900



CK2500-II Luffing Jib Rating Loads in Pounds

15 Counterweights + 2 Low Weights

Refer to notes page 8

140' Boom							140' Boom						
Load Radius (ft.)	110 ft Jib						Load Radius (ft.)	120 ft Jib					
	Boom Angle (deg.)							Boom Angle (deg.)					
	88	83	78	73	68	63		88	83	78	73	68	63
45	88,500 *						45						
50	88,500 *						50	88,500 *					
55	88,500 *						55	87,500 *					
60	88,500 *						60	84,600 *					
65	82,400 *						65	79,800 *					
70	73,800 *	82,200					70	73,600 *	82,200				
75	66,800 *	76,000					75	66,500 *	75,600				
80	60,600 *	70,100					80	60,600 *	69,600				
85	55,500 *	64,800					85	55,300 *	64,600				
90	51,100 *	60,400	56,000				90	50,900 *	59,900				
95	47,100 *	56,400	52,200				95	46,900 *	56,200	51,800			
100	43,600 *	52,900	49,100				100	43,600 *	52,600	48,700			
110	37,700 *	46,300 *	43,400	40,700			110	37,700 *	46,300 *	42,900			
120		40,100 *	39,000	36,300			120	33,000 *	39,900 *	38,500	35,900		
130		34,800 *	35,000	32,800	29,900		130		34,800 *	34,800	32,400		
140			31,900	29,900	27,300		140		30,600 *	31,500	29,500	26,600	
150				27,300	24,900	23,100	150			28,800	26,900	24,400	
160					22,700	21,100	160				24,600	22,200	20,700
170						19,400	170					20,500	18,900
180							180						17,400

140' Boom							140' Boom						
Load Radius (ft.)	130 ft Jib						Load Radius (ft.)	140 ft Jib					
	Boom Angle (deg.)							Boom Angle (deg.)					
	88	83	78	73	68	63		88	83	78	73	68	63
50	76,500 *						50						
55	74,700 *						55	64,800 *					
60	70,300 *						60	61,700 *					
65	66,300 *						65	57,900 *					
70	62,600 *						70	54,900 *					
75	59,500 *	68,300 *					75	51,800 *					
80	56,400 *	64,600 *					80	49,100 *	54,400 *				
85	53,800 *	61,000 *					85	46,700 *	51,500 *				
90	51,300 *	57,900 *					90	44,500 *	48,900 *				
95	47,800 *	55,300 *	52,000				95	42,500 *	46,700 *				
100	44,300 *	52,200 *	48,700				100	40,700 *	44,500 *	48,200			
110	38,300 *	46,000 *	43,200				110	37,400 *	40,700 *	42,700			
120	33,700 *	39,900 *	38,500	35,700			120	33,500 *	37,400 *	38,100			
130	29,700 *	34,800 *	34,800	32,100			130	29,500 *	34,800 *	34,300	32,100		
140		30,800 *	31,500	29,100	26,900		140	26,200 *	31,300 *	31,300	29,100		
150		27,100 *	28,800	26,600	24,400		150		27,700 *	28,400	26,400	24,000	
160			26,400	24,400	22,200	20,200	160		24,600 *	26,200	24,200	21,800	
170				22,400	20,500	18,500	170			24,000	22,400	20,000	18,300
180					18,900	16,900	180				20,700	18,500	16,700
190						15,600	190					17,100	15,400
200							200						14,100

CK2500-II Luffing Jib Rating Loads in Pounds

15 Counterweights + 2 Low Weights

Refer to notes page 8

140' Boom							140' Boom						
Load Radius (ft.)	150 ft Jib						Load Radius (ft.)	160 ft Jib					
	Boom Angle (deg.)							Boom Angle (deg.)					
	88	83	78	73	68	63		88	83	78	73	68	63
55	54,400 *						55						
60	51,100 *						60	44,300 *					
65	48,200 *						65	41,600 *					
70	45,600 *						70	39,200 *					
75	43,200 *						75	37,000 *					
80	41,000 *	46,900 *					80	35,000 *					
85	39,000 *	44,300 *					85	33,200 *	38,100 *				
90	37,000 *	42,100 *					90	31,700 *	36,100 *				
95	35,500 *	39,900 *					95	30,200 *	34,100 *				
100	33,900 *	38,100 *					100	28,600 *	32,400 *				
110	31,000 *	34,600 *	39,000 *				110	26,200 *	29,500 *	33,200 *			
120	28,600 *	31,700 *	35,500 *				120	24,000 *	26,900 *	30,200 *			
130	26,600 *	29,300 *	32,600 *	31,900			130	22,200 *	24,600 *	27,500 *			
140	24,900 *	27,300 *	29,900 *	28,800			140	20,500 *	22,700 *	25,300 *	28,200 *		
150	23,300 *	25,300 *	27,700 *	26,400	24,200		150	19,100 *	21,100 *	23,300 *	25,700 *		
160		23,800 *	26,000 *	24,200	22,000		160	17,800 *	19,600 *	21,600 *	23,800	21,600	
170		22,200 *	24,200	22,200	20,200		170		18,300 *	20,000 *	21,800	19,800	
180			22,400	20,500	18,700	16,500	180		17,100 *	18,700 *	20,200	18,300	16,000
190				19,100	17,400	15,200	190			17,600 *	18,700	16,900	14,500
200					16,000	13,800	200				17,400	15,400	13,200
210						12,700	210					14,300	12,100
220							220						11,200

140' Boom							140' Boom						
Load Radius (ft.)	170 ft Jib						Load Radius (ft.)	170 ft Jib					
	Boom Angle (deg.)							Boom Angle (deg.)					
	88	83	78	73	68	63		88	83	78	73	68	63
60	39,400 *												
65	37,000 *												
70	34,800 *												
75	32,800 *												
80	31,000 *												
85	29,500 *												
90	28,000 *	31,900 *											
95	26,400 *	30,200 *											
100	25,300 *	28,600 *											
110	22,900 *	26,000 *											
120	20,900 *	23,500 *	26,600 *										
130	19,100 *	21,600 *	24,000 *										
140	17,600 *	19,600 *	22,000 *	24,600 *									
150	16,300 *	18,000 *	20,200 *	22,400 *									
160	15,200 *	16,700 *	18,500 *	20,500 *									
170	14,100 *	15,600 *	17,100 *	18,900 *	19,600								
180		14,500 *	15,800 *	17,400 *	18,000								
190		13,600 *	14,700 *	16,300 *	16,500	14,100							
200			13,800 *	15,200 *	15,200	13,000							
210				14,100 *	13,800	11,600							
220					12,700	10,800							
230						9,900							

CK2500-II Luffing Jib Rating Loads in Pounds

15 Counterweights + 2 Low Weights

Refer to notes page 8

150' Boom							150' Boom						
Load Radius (ft.)	70 ft Jib						Load Radius (ft.)	80 ft Jib					
	Boom Angle (deg.)							Boom Angle (deg.)					
	88	83	78	73	68	63		88	83	78	73	68	63
40	118,000 *						40	118,000 *					
45	118,000 *						45	118,000 *					
50	118,000 *						50	118,000 *					
55	103,800 *	109,900					55	104,700 *					
60	90,600 *	100,700					60	91,500 *	99,800				
65	80,200 *	91,200					65	80,900 *	90,800				
70	71,600 *	83,100					70	72,300 *	82,600				
75	64,300 *	76,000	70,700				75	65,200 *	75,800				
80	55,100 *	70,100	65,200				80	59,000 *	69,800	64,800			
85		65,000	60,400				85	54,000 *	64,800	59,900			
90		60,400	56,200	52,600			90	46,500 *	60,100	55,700			
95			52,400	49,100			95		56,200	52,000	48,700		
100			49,100	46,000			100		52,600	48,700	45,600		
110				40,700	37,400		110			43,200	40,300		
120				36,600	33,500		120				36,100	33,000	
130					30,200	28,000	130				32,600	29,700	
140						25,300	140					26,900	24,900
150							150						22,700

150' Boom							150' Boom						
Load Radius (ft.)	90 ft Jib						Load Radius (ft.)	100 ft Jib					
	Boom Angle (deg.)							Boom Angle (deg.)					
	88	83	78	73	68	63		88	83	78	73	68	63
40	88,500 *						40	88,500 *					
45	88,500 *						45	88,500 *					
50	88,500 *						50	88,500 *					
55	88,500 *						55	88,500 *					
60	88,500 *	88,500					60	88,500 *					
65	81,500 *	88,500					65	81,500 *	88,500				
70	72,900 *	82,400					70	72,900 *	82,000				
75	65,700 *	75,600					75	65,900 *	75,100				
80	59,700 *	69,600	64,300				80	59,700 *	69,200				
85	54,400 *	64,600	59,700				85	54,600 *	64,100	59,000			
90	50,000 *	59,900	55,500				90	50,200 *	59,700	55,100			
95	46,000 *	56,000	51,800				95	46,300 *	55,700	51,300			
100	39,900 *	52,600	48,500	45,200			100	42,700 *	52,200	48,000			
110		45,600 *	42,900	40,100			110	34,600 *	45,800 *	42,500	39,600		
120			38,500	35,900	32,600		120		39,400 *	38,100	35,500		
130				32,400	29,300		130			34,300	31,900	28,800	
140				29,300	26,600	24,600	140				28,800	26,200	
150					24,200	22,400	150					23,800	21,800
160						20,500	160					21,800	19,800
170							170						18,300



CK2500-II Luffing Jib Rating Loads in Pounds

15 Counterweights + 2 Low Weights

Refer to notes page 8

150' Boom							150' Boom						
Load Radius (ft.)	110 ft Jib						Load Radius (ft.)	120 ft Jib					
	Boom Angle (deg.)							Boom Angle (deg.)					
	88	83	78	73	68	63		88	83	78	73	68	63
45	88,500 *						45						
50	88,500 *						50	85,800 *					
55	88,500 *						55	84,900 *					
60	88,500 *						60	83,900 *					
65	83,100 *						65	80,000 *					
70	74,300 *	81,500					70	74,000 *	81,500				
75	67,000 *	75,400					75	67,000 *	74,900				
80	61,000 *	69,400					80	60,800 *	69,200				
85	55,700 *	64,300					85	55,500 *	63,900				
90	51,300 *	59,900	55,300				90	51,100 *	59,500				
95	47,400 *	56,000	51,500				95	47,100 *	55,500	51,100			
100	43,800 *	52,400	48,200				100	43,600 *	52,200	47,800			
110	37,900 *	46,500	42,700	39,900			110	37,900 *	46,300	42,300			
120	30,800 *	40,500 *	38,300	35,700			120	33,000 *	40,500 *	37,900	35,200		
130		35,200 *	34,600	32,100			130		35,500 *	34,100	31,700		
140			31,500	29,100	26,200		140		31,000 *	31,000	28,600	25,700	
150				26,600	24,000	22,000	150			28,400	26,200	23,500	
160					22,000	20,200	160				24,000	21,600	19,600
170					20,200	18,500	170					19,800	17,800
180						16,900	180					18,300	16,300
190							190						14,900

150' Boom							150' Boom						
Load Radius (ft.)	130 ft Jib						Load Radius (ft.)	140 ft Jib					
	Boom Angle (deg.)							Boom Angle (deg.)					
	88	83	78	73	68	63		88	83	78	73	68	63
50	76,100 *						50						
55	75,400 *						55	64,800 *					
60	70,500 *						60	61,900 *					
65	66,500 *						65	58,200 *					
70	62,800 *						70	54,900 *					
75	59,500 *	69,200 *					75	52,000 *					
80	56,600 *	65,200 *					80	49,300 *	55,100 *				
85	54,000 *	61,900 *					85	46,900 *	52,200 *				
90	51,500 *	58,600 *					90	44,700 *	49,600 *				
95	48,000 *	55,300					95	42,700 *	47,100 *				
100	44,500 *	51,800	48,000				100	40,700 *	44,900 *				
110	38,500 *	46,000	42,500				110	37,400 *	41,200 *	42,100			
120	33,700 *	40,500 *	37,900	34,800			120	33,500 *	37,900 *	37,400			
130	29,700 *	35,500 *	34,100	31,300			130	29,500 *	35,000 *	33,700	31,300		
140		31,000 *	31,000	28,400			140	26,200 *	31,700 *	30,600	28,400		
150		27,500 *	28,400	26,000	23,500		150		28,200 *	28,000	26,000	23,100	
160			26,000	23,800	21,600		160		25,100 *	25,700	23,800	21,100	
170				21,800	19,800	17,400	170			23,500	21,800	19,400	17,100
180					18,300	15,800	180				20,200	17,800	15,600
190					16,900	14,500	190					16,300	14,300
200						13,200	200					14,900	13,000
210							210						12,100

CK2500-II Luffing Jib Rating Loads in Pounds

15 Counterweights + 2 Low Weights

Refer to notes page 8

150' Boom							150' Boom						
Load Radius (ft.)	150 ft Jib						Load Radius (ft.)	160 ft Jib					
	Boom Angle (deg.)							Boom Angle (deg.)					
	88	83	78	73	68	63		88	83	78	73	68	63
55	54,600 *						55						
60	51,300 *						60	44,300 *					
65	48,200 *						65	41,600 *					
70	45,600 *						70	39,200 *					
75	43,200 *						75	37,200 *					
80	41,000 *						80	35,200 *					
85	39,000 *	44,900 *					85	33,200 *	38,500 *				
90	37,200 *	42,500 *					90	31,700 *	36,600 *				
95	35,500 *	40,300 *					95	30,200 *	34,600 *				
100	33,900 *	38,500 *					100	28,800 *	32,800 *				
110	31,000 *	35,000 *	39,600 *				110	26,200 *	29,700 *	33,900 *			
120	28,600 *	32,100 *	36,100 *				120	24,000 *	27,100 *	30,800 *			
130	26,600 *	29,500 *	33,000 *	31,300			130	22,200 *	24,900 *	28,000 *			
140	24,900 *	27,300 *	30,400 *	28,200			140	20,500 *	22,900 *	25,500 *	27,700		
150	23,300 *	25,500 *	28,200	25,700			150	19,100 *	21,100 *	23,500 *	25,300		
160		24,000 *	26,000	23,500	21,300		160	17,800 *	19,600 *	21,800 *	23,100	20,900	
170		22,400 *	23,800	21,800	19,600		170		18,500 *	20,200 *	21,300	19,100	
180			22,000	20,000	18,000	15,400	180		17,400 *	18,900 *	19,600	17,400	
190				18,500	16,500	14,100	190			17,800 *	18,000	16,000	13,400
200					15,200	13,000	200				16,900	14,700	12,300
210					14,100	11,900	210					13,400	11,200
220						10,800	220					12,300	10,300
230							230						9,400

150' Boom													
Load Radius (ft.)	170 ft Jib												
	Boom Angle (deg.)												
	88	83	78	73	68	63							
65	37,200 *												
70	35,000 *												
75	33,000 *												
80	31,000 *												
85	29,500 *												
90	28,000 *	32,400 *											
95	26,600 *	30,600 *											
100	25,300 *	29,100 *											
110	22,900 *	26,200 *											
120	20,900 *	23,800 *	27,100 *										
130	19,100 *	21,600 *	24,400 *										
140	17,600 *	19,800 *	22,400 *	25,300 *									
150	16,300 *	18,300 *	20,500 *	23,100 *									
160	15,200 *	16,900 *	18,900 *	21,100 *									
170	14,100 *	15,600 *	17,400 *	19,400 *	18,700								
180		14,500 *	16,000 *	17,800 *	16,900								
190		13,600 *	14,900 *	16,500 *	15,600	13,000							
200			14,100 *	15,400 *	14,300	11,900							
210				14,300 *	13,000	10,800							
220					12,100	9,900							
230						9,000							
240						8,100							

CK2500-II Luffing Jib Rating Loads in Pounds

15 Counterweights + 2 Low Weights

Refer to notes page 8

160' Boom							160' Boom						
Load Radius (ft.)	70 ft Jib						Load Radius (ft.)	80 ft Jib					
	Boom Angle (deg.)							Boom Angle (deg.)					
	88	83	78	73	68	63		88	83	78	73	68	63
40	118,000 *						40	88,500 *					
45	118,000 *						45	88,500 *					
50	118,000 *						50	88,500 *					
55	104,700 *	109,300					55	88,500 *					
60	91,200 *	100,200					60	88,500 *	88,500				
65	80,700 *	90,600					65	81,500 *	88,500				
70	72,100 *	82,400					70	72,700 *	82,000				
75	64,600 *	75,600	69,600				75	65,700 *	75,100				
80	56,000 *	69,600	64,100				80	59,500 *	69,200	63,700			
85		64,600	59,500				85	54,200 *	64,100	59,000			
90		59,900	55,300				90	47,100 *	59,700	54,900			
95		56,000	51,500	47,800			95		55,700	51,100			
100			48,500	44,900			100		52,200	48,000	44,300		
110			42,700	39,600			110			42,500	39,200		
120				35,500	32,100		120				35,200	31,700	
130					29,100	26,600	130				31,700	28,400	
140						24,200	140					25,700	23,500
150							150						21,300

160' Boom							160' Boom						
Load Radius (ft.)	90 ft Jib						Load Radius (ft.)	100 ft Jib					
	Boom Angle (deg.)							Boom Angle (deg.)					
	88	83	78	73	68	63		88	83	78	73	68	63
40	88,500 *						40						
45	88,500 *						45	88,500 *					
50	88,500 *						50	88,500 *					
55	88,500 *						55	88,500 *					
60	88,500 *						60	88,500 *					
65	82,000 *	88,500					65	82,200 *	88,500				
70	73,400 *	81,800					70	73,400 *	81,300				
75	66,100 *	74,900					75	66,100 *	74,500				
80	59,900 *	69,000					80	60,100 *	68,500				
85	54,900 *	63,900	58,600				85	54,900 *	63,500				
90	50,200 *	59,500	54,400				90	50,400 *	59,000	54,000			
95	46,300 *	55,500	50,900				95	46,500 *	55,300	50,400			
100	40,300 *	52,200	47,600				100	42,900 *	51,800	47,100			
110		46,300	42,300	39,000			110	34,800 *	45,800	41,800	38,500		
120			37,900	34,800			120		40,100 *	37,200	34,300		
130				31,500	28,200		130			33,700	31,000	27,500	
140				28,600	25,500		140				28,200	25,100	
150					23,300	20,900	150				25,500	22,700	20,200
160						18,900	160					20,900	18,300
170							170						16,700



CK2500-II Luffing Jib Rating Loads in Pounds

15 Counterweights + 2 Low Weights

Refer to notes page 8

160' Boom							160' Boom						
Load Radius (ft.)	110 ft Jib						Load Radius (ft.)	120 ft Jib					
	Boom Angle (deg.)							Boom Angle (deg.)					
	88	83	78	73	68	63		88	83	78	73	68	63
45	88,500 *						45						
50	88,500 *						50	82,500 *					
55	88,500 *						55	81,800 *					
60	88,500 *						60	81,200 *					
65	83,500 *						65	80,200 *					
70	74,700 *	80,900					70	74,700 *					
75	67,400 *	74,900					75	67,200 *	74,000				
80	61,200 *	69,000					80	61,000 *	68,500				
85	56,000 *	63,900					85	55,700 *	63,500				
90	51,300 *	59,500					90	51,300 *	59,000				
95	47,400 *	55,500	50,700				95	47,400 *	55,100	50,200			
100	43,800 *	52,000	47,600				100	43,800 *	51,800	46,900			
110	37,900 *	46,300	42,100				110	37,900 *	45,800	41,600			
120	31,300 *	41,200 *	37,700	34,600			120	33,000 *	41,000	37,200	34,100		
130		35,900 *	33,900	31,300			130	27,300 *	35,900 *	33,500	30,800		
140			30,800	28,400	25,300		140		31,500 *	30,400	28,000	24,600	
150				25,700	22,900		150			27,700	25,500	22,400	
160				23,800	20,900	18,700	160				23,300	20,500	
170					19,400	16,900	170				21,600	18,700	16,300
180						15,400	180					17,100	14,700
190							190						13,600

160' Boom							160' Boom						
Load Radius (ft.)	130 ft Jib						Load Radius (ft.)	140 ft Jib					
	Boom Angle (deg.)							Boom Angle (deg.)					
	88	83	78	73	68	63		88	83	78	73	68	63
50	73,600 *						50						
55	72,900 *						55	64,800 *					
60	70,700 *						60	62,100 *					
65	66,800 *						65	58,400 *					
70	63,000 *						70	55,100 *					
75	59,700 *	70,100					75	52,200 *					
80	56,800 *	66,100					80	49,300 *	55,700 *				
85	54,000 *	62,600					85	46,900 *	52,900 *				
90	51,500 *	58,800					90	44,700 *	50,000 *				
95	48,200 *	54,900					95	42,700 *	47,600 *				
100	44,500 *	51,300	47,100				100	40,700 *	45,400 *				
110	38,500 *	45,600	41,600				110	37,400 *	41,400 *	41,200			
120	33,700 *	40,700	37,200				120	33,500 *	38,100 *	36,800			
130	29,700 *	35,900 *	33,500	30,400			130	29,500 *	35,200 *	33,200	30,400		
140		31,500 *	30,400	27,500			140	26,200 *	32,100 *	30,200	27,500		
150		28,000 *	27,700	25,100	22,400		150		28,400 *	27,500	25,100		
160			25,500	23,100	20,500		160		25,300 *	25,100	22,900	20,000	
170				21,100	18,700	15,800	170			23,100	21,100	18,000	
180				19,600	17,100	14,300	180				19,600	16,500	14,300
190					15,800	13,200	190				18,000	15,200	13,000
200						11,900	200					13,800	11,900
210							210						10,800

CK2500-II Luffing Jib Rating Loads in Pounds

15 Counterweights + 2 Low Weights

Refer to notes page 8

160' Boom							160' Boom						
Load Radius (ft.)	150 ft Jib						Load Radius (ft.)	160 ft Jib					
	Boom Angle (deg.)							Boom Angle (deg.)					
	88	83	78	73	68	63		88	83	78	73	68	63
60	51,500 *						60	44,500 *					
65	48,500 *						65	41,800 *					
70	45,800 *						70	39,400 *					
75	43,400 *						75	37,200 *					
80	41,200 *						80	35,200 *					
85	39,200 *	45,400 *					85	33,500 *					
90	37,200 *	42,900 *					90	31,700 *	37,000 *				
95	35,500 *	40,700 *					95	30,200 *	35,000 *				
100	33,900 *	38,800 *					100	28,800 *	33,200 *				
110	31,300 *	35,500 *	40,500 *				110	26,200 *	30,200 *				
120	28,800 *	32,400 *	36,800 *				120	24,200 *	27,300 *	31,300 *			
130	26,600 *	29,700 *	33,500				130	22,200 *	25,100 *	28,400 *			
140	24,900 *	27,500 *	30,400	27,500			140	20,500 *	23,100 *	26,000 *	27,100		
150	23,300 *	25,700 *	27,700	24,900			150	19,100 *	21,300 *	24,000 *	24,400		
160		24,000 *	25,300	22,900	20,200		160	17,800 *	19,800 *	22,000 *	22,400		
170		22,700 *	23,300	20,900	18,500		170		18,500 *	20,500 *	20,700	17,800	
180			21,600	19,400	16,900	14,100	180		17,400 *	19,100 *	18,900	16,300	
190				18,000	15,400	12,700	190			17,800 *	17,600	14,700	12,100
200				16,700	14,100	11,600	200				16,300	13,600	11,000
210					13,000	10,500	210				14,900	12,500	9,900
220						9,700	220					11,400	9,000
230							230						8,300

160' Boom							160' Boom						
Load Radius (ft.)	170 ft Jib						Load Radius (ft.)	170 ft Jib					
	Boom Angle (deg.)							Boom Angle (deg.)					
	88	83	78	73	68	63		88	83	78	73	68	63
65	37,200 *												
70	35,000 *												
75	33,000 *												
80	31,300 *												
85	29,500 *												
90	28,000 *	32,800 *											
95	26,600 *	31,000 *											
100	25,300 *	29,300 *											
110	22,900 *	26,400 *											
120	20,900 *	24,000 *	27,500 *										
130	19,100 *	21,800 *	25,100 *										
140	17,600 *	20,000 *	22,700 *										
150	16,300 *	18,500 *	20,900 *	23,500 *									
160	15,200 *	16,900 *	19,100 *	21,600 *									
170	14,100 *	15,600 *	17,600 *	19,800 *	17,400								
180		14,500 *	16,300 *	18,300 *	15,800								
190		13,600 *	15,200 *	16,900 *	14,500								
200			14,100 *	15,600 *	13,200	10,500							
210				14,500 *	12,100	9,400							
220				13,400	11,000	8,500							
230					10,100	7,900							
240						7,000							

CK2500-II Luffing Jib Rating Loads in Pounds

15 Counterweights + 2 Low Weights

Refer to notes page 8

170' Boom							170' Boom						
Load Radius (ft.)	70 ft Jib						Load Radius (ft.)	80 ft Jib					
	Boom Angle (deg.)							Boom Angle (deg.)					
	88	83	78	73	68	63		88	83	78	73	68	63
40	88,500 *						40	88,500 *					
45	88,500 *						45	88,500 *					
50	88,500 *						50	88,500 *					
55	88,500 *	88,500					55	88,500 *					
60	88,500 *	88,500					60	88,500 *	88,500				
65	81,300 *	88,500					65	82,000 *	88,500				
70	72,500 *	81,800					70	73,200 *	81,300				
75	65,000 *	74,900					75	65,900 *	74,500				
80	56,600 *	69,000	63,000				80	59,700 *	68,700	62,600			
85		63,900	58,400				85	54,400 *	63,700	57,900			
90		59,500	54,400				90	47,800 *	59,300	54,000			
95		55,500	50,700				95		55,300	50,200			
100			47,600	43,600			100		51,800	47,100			
110			42,100	38,800			110			41,600	38,300		
120				34,600	31,000		120			37,200	34,100	30,400	
130					27,700		130				30,800	27,300	
140					25,300	22,700	140					24,600	22,000
150						20,500	150					22,700	19,800
160							160						17,800

170' Boom							170' Boom						
Load Radius (ft.)	90 ft Jib						Load Radius (ft.)	100 ft Jib					
	Boom Angle (deg.)							Boom Angle (deg.)					
	88	83	78	73	68	63		88	83	78	73	68	63
45	88,500 *						45	88,500 *					
50	88,500 *						50	88,500 *					
55	88,500 *						55	88,500 *					
60	88,500 *						60	88,500 *					
65	82,600 *	88,500					65	84,000 *					
70	73,800 *	81,100					70	74,900 *	80,200				
75	66,500 *	74,300					75	67,400 *	74,300				
80	60,400 *	68,500					80	61,200 *	68,500				
85	55,100 *	63,500	57,700				85	56,000 *	63,500				
90	50,400 *	59,000	53,500				90	51,300 *	59,000	53,500			
95	46,300 *	55,100	50,000				95	47,100 *	55,100	50,000			
100	41,000 *	51,500	46,900				100	43,600 *	51,800	46,700			
110		45,800	41,400	37,900			110	35,900 *	45,800	41,400			
120			37,000	33,900			120		41,000	37,000	33,700		
130			33,500	30,600	27,100		130			33,200	30,400		
140				27,700	24,400		140			30,400	27,500	24,200	
150					22,200	19,400	150				25,100	22,000	
160						17,400	160					20,000	17,100
170						15,800	170						15,600
180							180						14,300

CK2500-II Luffing Jib Rating Loads in Pounds

15 Counterweights + 2 Low Weights

Refer to notes page 8

170' Boom							170' Boom						
Load Radius (ft.)	110 ft Jib						Load Radius (ft.)	120 ft Jib					
	Boom Angle (deg.)							Boom Angle (deg.)					
	88	83	78	73	68	63		88	83	78	73	68	63
45	88,500 *						45						
50	88,500 *						50	79,600 *					
55	88,500 *						55	78,800 *					
60	88,000 *						60	78,000 *					
65	84,200 *						65	77,100 *					
70	75,100 *	80,000					70	75,100 *					
75	67,900 *	74,300					75	67,600 *	73,400				
80	61,500 *	68,300					80	61,500 *	67,900				
85	56,200 *	63,200					85	56,200 *	63,000				
90	51,500 *	58,800					90	51,500 *	58,600				
95	47,600 *	55,100	49,800				95	47,600 *	54,600				
100	44,000 *	51,500	46,700				100	43,800 *	51,100	46,300			
110	38,100 *	45,800	41,200				110	37,900 *	45,400	40,700			
120	31,500 *	41,000	36,800	33,700			120	33,200 *	40,500	36,300			
130		36,300 *	33,200	30,400			130	27,500 *	36,300 *	32,800	29,900		
140			30,200	27,500	24,200		140		31,900 *	29,700	27,100		
150			27,500	25,100	22,000		150			27,100	24,600	21,300	
160				23,100	20,000	17,100	160			24,900	22,700	19,100	
170					18,300	15,400	170				20,700	17,400	14,700
180						14,100	180					16,000	13,400
190						13,000	190						12,300
200							200						11,200

170' Boom							170' Boom						
Load Radius (ft.)	130 ft Jib						Load Radius (ft.)	140 ft Jib					
	Boom Angle (deg.)							Boom Angle (deg.)					
	88	83	78	73	68	63		88	83	78	73	68	63
55	70,500 *						55	59,000 *					
60	69,600 *						60	59,000 *					
65	67,000 *						65	58,600 *					
70	63,200 *						70	55,300 *					
75	59,900 *						75	52,200 *					
80	56,800 *	67,000 *					80	49,600 *	56,400 *				
85	54,200 *	62,600					85	47,100 *	53,500 *				
90	51,800 *	58,200					90	44,900 *	50,700 *				
95	48,200 *	54,400					95	42,700 *	48,200 *				
100	44,700 *	50,900					100	41,000 *	45,800 *				
110	38,800 *	45,200	41,000				110	37,700 *	41,800 *	40,500			
120	33,900 *	40,300	36,600				120	33,700 *	38,500 *	36,100			
130	29,700 *	36,300	33,000	29,500			130	29,700 *	35,700 *	32,600			
140	24,900 *	31,900 *	29,900	26,600			140	26,200 *	32,600 *	29,500	26,600		
150		28,200 *	27,300	24,200	21,300		150		28,800 *	26,900	24,200		
160			25,100	22,200	19,400		160		25,500 *	24,600	22,200	18,700	
170			23,100	20,500	17,600		170			22,700	20,500	16,900	
180				18,900	16,000	13,000	180				18,900	15,400	12,700
190					14,700	11,600	190				17,400	14,100	11,600
200						10,800	200					12,700	10,500
210						9,700	210						9,700
220							220						8,800

CK2500-II Luffing Jib Rating Loads in Pounds

15 Counterweights + 2 Low Weights

Refer to notes page 8

170' Boom							170' Boom						
Load Radius (ft.)	150 ft Jib						Load Radius (ft.)	160 ft Jib					
	Boom Angle (deg.)							Boom Angle (deg.)					
	88	83	78	73	68	63		88	83	78	73	68	63
60	51,800 *						60	44,700 *					
65	48,700 *						65	42,100 *					
70	45,800 *						70	39,600 *					
75	43,400 *						75	37,400 *					
80	41,200 *						80	35,200 *					
85	39,200 *	46,000 *					85	33,500 *					
90	37,200 *	43,600 *					90	31,900 *	37,400 *				
95	35,700 *	41,400 *					95	30,400 *	35,500 *				
100	34,100 *	39,200 *					100	28,800 *	33,700 *				
110	31,300 *	35,700 *	40,700				110	26,400 *	30,400 *				
120	28,800 *	32,600 *	36,600				120	24,200 *	27,700 *	31,900 *			
130	26,600 *	30,200 *	32,800				130	22,200 *	25,300 *	29,100 *			
140	24,900 *	27,700 *	29,700	26,600			140	20,700 *	23,300 *	26,400 *			
150	23,300 *	26,000 *	27,100	24,200			150	19,100 *	21,600 *	24,400 *	23,800		
160		24,200 *	24,900	22,000			160	17,800 *	20,000 *	22,400 *	21,600		
170		22,700 *	22,900	20,200	17,400		170		18,700 *	20,700 *	19,800	16,700	
180			21,100	18,700	15,800		180		17,400 *	19,400 *	18,300	15,200	
190				17,400	14,300	11,400	190			18,000 *	16,900	13,600	
200				16,000	13,200	10,300	200				15,400	12,500	9,700
210					12,100	9,400	210				14,300	11,400	8,800
220						8,500	220					10,500	7,900
230						7,700	230						7,200
240							240						6,600

170' Boom													
Load Radius (ft.)	170 ft Jib												
	Boom Angle (deg.)												
	88	83	78	73	68	63							
65	37,400 *												
70	35,200 *												
75	33,200 *												
80	31,300 *												
85	29,700 *												
90	28,200 *	33,200 *											
95	26,600 *	31,500 *											
100	25,300 *	29,700 *											
110	23,100 *	26,600 *											
120	20,900 *	24,200 *	28,200 *										
130	19,100 *	22,000 *	25,500 *										
140	17,600 *	20,200 *	23,100 *										
150	16,300 *	18,500 *	21,100 *	23,300									
160	15,200 *	17,100 *	19,400 *	21,300									
170	14,100 *	15,800 *	17,800 *	19,600									
180		14,700 *	16,500 *	18,000	14,700								
190		13,600 *	15,400 *	16,500	13,400								
200			14,300 *	14,900	12,100	9,200							
210				13,800	11,000	8,300							
220				12,700	10,100	7,400							
230					9,200	6,800							
240						6,100							
250						5,500							



CK2500-II Luffing Jib Rating Loads in Pounds

15 Counterweights + 2 Low Weights

Refer to notes page 8

180' Boom							180' Boom						
Load Radius (ft.)	70 ft Jib						Load Radius (ft.)	80 ft Jib					
	Boom Angle (deg.)							Boom Angle (deg.)					
	88	83	78	73	68	63		88	83	78	73	68	63
40	88,500 *						40	88,500 *					
45	88,500 *						45	88,500 *					
50	88,500 *						50	88,500 *					
55	87,000 *						55	85,500 *					
60	81,300 *	88,500					60	80,000 *	88,500				
65	76,200 *	88,500					65	75,100 *	88,500				
70	72,100 *	81,100					70	70,700 *	80,700				
75	65,400 *	74,300					75	67,000 *	73,800				
80	57,500 *	68,300	61,900				80	60,800 *	68,100				
85		63,500	57,300				85	55,300 *	63,000	57,300			
90		59,000	53,300				90	48,900 *	58,600	53,300			
95		55,100	49,800				95		54,900	49,800			
100			46,700	42,500			100		51,300	46,700			
110			41,400	37,700			110			41,200	37,000		
120				33,500	29,500		120			37,000	33,000		
130					26,600		130				29,700	26,400	
140					24,000	20,700	140					24,000	
150						18,700	150					21,800	18,000
160							160						16,300

180' Boom							180' Boom						
Load Radius (ft.)	90 ft Jib						Load Radius (ft.)	100 ft Jib					
	Boom Angle (deg.)							Boom Angle (deg.)					
	88	83	78	73	68	63		88	83	78	73	68	63
45	88,500 *						45	88,500 *					
50	88,500 *						50	88,500 *					
55	85,100 *						55	84,400 *					
60	79,600 *						60	78,900 *					
65	74,500 *	87,900					65	73,800 *					
70	70,100 *	80,900					70	69,600 *	79,600				
75	66,300 *	74,000					75	65,700 *	73,600				
80	61,500 *	68,300					80	61,500 *	67,900				
85	56,000 *	63,200					85	56,200 *	62,800				
90	51,300 *	58,800	52,900				90	51,500 *	58,400				
95	47,100 *	55,100	49,300				95	47,400 *	54,600	48,900			
100	42,100 *	51,500	46,300				100	43,800 *	51,100	45,800			
110		45,800	41,000	37,200			110	36,100 *	45,400	40,500			
120			36,800	33,200			120		40,700	36,300	32,800		
130			33,000	29,900	26,200		130			32,600	29,500		
140				27,100	23,500		140			29,700	26,600	22,900	
150					21,300		150				24,400	20,700	
160					19,400	16,300	160					18,700	15,600
170						14,700	170					16,900	14,100
180							180						12,700

CK2500-II Luffing Jib Rating Loads in Pounds

15 Counterweights + 2 Low Weights

Refer to notes page 8

180' Boom							180' Boom						
Load Radius (ft.)	110 ft Jib						Load Radius (ft.)	120 ft Jib					
	Boom Angle (deg.)							Boom Angle (deg.)					
	88	83	78	73	68	63		88	83	78	73	68	63
50	85,300 *						50	71,700 *					
55	84,200 *						55	70,500 *					
60	78,700 *						60	69,400 *					
65	73,600 *						65	68,300 *					
70	69,200 *						70	67,100 *					
75	65,200 *	72,500					75	64,800 *	72,700				
80	61,900 *	67,600					80	61,200 *	67,400				
85	56,400 *	62,800					85	56,400 *	62,400				
90	51,800 *	58,400					90	51,800 *	57,900				
95	47,800 *	54,600	48,900				95	47,600 *	54,200				
100	44,300 *	51,100	45,800				100	44,000 *	50,700	45,200			
110	38,100 *	45,400	40,500				110	38,100 *	44,900	39,900			
120	31,900 *	40,500	36,100	32,600			120	33,200 *	40,300	35,700			
130		36,600	32,600	29,300			130	27,700 *	36,300	32,100	28,800		
140			29,500	26,600			140		32,400 *	29,100	26,200		
150			27,100	24,200	20,500		150			26,600	23,800	19,800	
160				22,200	18,500		160			24,400	21,800	17,800	
170					16,700	13,800	170				20,000	16,000	13,200
180					15,400	12,500	180					14,700	11,900
190						11,400	190					13,400	10,800
200							200						9,900

180' Boom							180' Boom						
Load Radius (ft.)	130 ft Jib						Load Radius (ft.)	140 ft Jib					
	Boom Angle (deg.)							Boom Angle (deg.)					
	88	83	78	73	68	63		88	83	78	73	68	63
55	59,000 *						55	59,000 *					
60	59,000 *						60	59,000 *					
65	59,000 *						65	58,800 *					
70	59,000 *						70	55,300 *					
75	59,000 *						75	52,400 *					
80	57,100 *	59,000					80	49,600 *					
85	54,400 *	59,000					85	47,100 *	54,200 *				
90	51,800 *	57,700					90	44,900 *	51,300 *				
95	48,500 *	53,800					95	42,900 *	48,700 *				
100	44,900 *	50,400					100	41,000 *	46,500 *				
110	38,800 *	44,700	40,100				110	37,700 *	42,300 *	39,600			
120	33,900 *	39,900	35,900				120	33,700 *	38,800 *	35,500			
130	29,900 *	36,100	32,100	28,600			130	29,700 *	35,900 *	31,700			
140	25,100 *	32,400 *	29,300	25,700			140	26,200 *	32,800 *	28,800	25,700		
150		28,600 *	26,600	23,500			150	22,200 *	29,300 *	26,200	23,500		
160			24,400	21,300	17,800		160		26,000 *	24,000	21,300	17,100	
170			22,400	19,800	16,300		170			22,000	19,600	15,600	
180				18,300	14,700	11,400	180			20,500	18,000	14,100	
190					13,400	10,300	190				16,700	12,700	10,100
200					12,300	9,200	200					11,600	9,200
210						8,300	210					10,800	8,300
220							220						7,400

CK2500-II Luffing Jib Rating Loads in Pounds

15 Counterweights + 2 Low Weights

Refer to notes page 8

180' Boom							180' Boom						
Load Radius (ft.)	150 ft Jib						Load Radius (ft.)	160 ft Jib					
	Boom Angle (deg.)							Boom Angle (deg.)					
	88	83	78	73	68	63		88	83	78	73	68	63
60	51,800 *						60	44,900 *					
65	48,900 *						65	42,100 *					
70	46,000 *						70	39,600 *					
75	43,600 *						75	37,400 *					
80	41,400 *						80	35,500 *					
85	39,200 *	46,700 *					85	33,700 *					
90	37,400 *	44,000 *					90	31,900 *	37,900 *				
95	35,700 *	41,800 *					95	30,400 *	35,900 *				
100	34,100 *	39,600 *					100	28,800 *	33,900 *				
110	31,300 *	36,100 *					110	26,400 *	30,600 *				
120	28,800 *	33,000 *	35,700				120	24,200 *	28,000 *	32,600 *			
130	26,600 *	30,400 *	32,100				130	22,200 *	25,500 *	29,500 *			
140	24,900 *	28,000 *	29,100	25,700			140	20,700 *	23,500 *	26,900 *			
150	23,300 *	26,000 *	26,600	23,300			150	19,100 *	21,600 *	24,600 *	22,900		
160		24,400 *	24,400	21,300			160	17,800 *	20,000 *	22,700 *	20,900		
170		22,900 *	22,400	19,600	16,000		170		18,700 *	21,100 *	19,100		
180			20,700	18,000	14,500		180		17,600 *	19,600 *	17,400	13,800	
190			19,100	16,500	13,200	9,900	190			18,300 *	15,800	12,500	
200				15,200	12,100	9,000	200			17,100 *	14,500	11,400	8,300
210					11,000	8,100	210				13,400	10,300	7,400
220					10,100	7,200	220					9,400	6,600
230						6,600	230					8,500	5,900

180' Boom													
Load Radius (ft.)	170 ft Jib												
	Boom Angle (deg.)												
	88	83	78	73	68	63							
65	37,700 *												
70	35,200 *												
75	33,200 *												
80	31,500 *												
85	29,700 *												
90	28,200 *												
95	26,600 *	31,700 *											
100	25,300 *	30,200 *											
110	23,100 *	27,100 *											
120	21,100 *	24,400 *											
130	19,400 *	22,200 *	26,000 *										
140	17,800 *	20,500 *	23,500 *										
150	16,300 *	18,700 *	21,600 *	22,700									
160	15,200 *	17,100 *	19,800 *	20,500									
170	14,100 *	15,800 *	18,000 *	18,700									
180		14,700 *	16,700 *	16,900	13,400								
190		13,800 *	15,600 *	15,400	12,100								
200			14,500 *	14,100	11,000								
210			13,600 *	13,000	9,900	7,000							
220				11,900	9,000	6,100							
230					8,100								
240					7,400								

CK2500-II Luffing Jib Rating Loads in Pounds

15 Counterweights + 2 Low Weights

Refer to notes page 8

190' Boom							190' Boom						
Load Radius (ft.)	70 ft Jib						Load Radius (ft.)	80 ft Jib					
	Boom Angle (deg.)							Boom Angle (deg.)					
	88	83	78	73	68	63		88	83	78	73	68	63
45	88,100 *						45	87,700 *					
50	81,500 *						50	81,100 *					
55	75,800 *						55	75,400 *					
60	71,000 *	85,700 *					60	70,300 *					
65	66,800 *	79,300 *					65	65,900 *	78,700 *				
70	63,000 *	73,800 *					70	62,100 *	73,400 *				
75	59,700 *	69,200 *					75	58,600 *	68,500 *				
80	57,100 *	65,000 *	61,500				80	55,700 *	64,300 *				
85		61,200 *	56,800				85	53,100 *	60,600 *	56,400			
90		58,200 *	52,900				90	49,600 *	57,300 *	52,400			
95		54,900	49,300				95		54,400 *	48,900			
100			46,300				100		51,300	45,800			
110			41,000	37,000			110			40,500	36,600		
120				33,000			120			36,300	32,600		
130				29,700	26,000		130				29,300	25,300	
140					23,300		140				26,600	22,700	
150						17,600	150					20,500	16,900
160						15,800	160						15,200
170							170						13,800

190' Boom							190' Boom						
Load Radius (ft.)	90 ft Jib						Load Radius (ft.)	100 ft Jib					
	Boom Angle (deg.)							Boom Angle (deg.)					
	88	83	78	73	68	63		88	83	78	73	68	63
45	85,300 *						45	84,800 *					
50	79,100 *						50	78,400 *					
55	73,600 *						55	72,900 *					
60	68,700 *						60	68,300 *					
65	64,600 *	78,200 *					65	63,900 *					
70	60,800 *	72,900 *					70	60,100 *	72,300 *				
75	57,500 *	68,100 *					75	56,800 *	67,400 *				
80	54,600 *	63,900 *					80	54,000 *	63,200 *				
85	52,000 *	60,100 *					85	51,100 *	59,500 *				
90	49,600 *	56,800 *	52,400				90	48,700 *	56,200 *				
95	47,600 *	53,800 *	48,900				95	46,500 *	53,100 *	48,500			
100	43,200 *	51,100	45,800				100	44,700 *	50,400 *	45,400			
110		45,400	40,700				110	37,200 *	44,900	40,300			
120			36,300	32,400			120		40,300	35,900	31,700		
130			32,800	29,100			130			32,400	28,600		
140				26,400	22,700		140			29,500	26,000	22,000	
150				24,000	20,500		150				23,500	19,800	
160					18,700	14,700	160				21,600	18,000	
170						13,400	170					16,300	12,700
180						12,100	180						11,400
190							190						10,300

CK2500-II Luffing Jib Rating Loads in Pounds

15 Counterweights + 2 Low Weights

Refer to notes page 8

190' Boom							190' Boom						
Load Radius (ft.)	110 ft Jib						Load Radius (ft.)	120 ft Jib					
	Boom Angle (deg.)							Boom Angle (deg.)					
	88	83	78	73	68	63		88	83	78	73	68	63
50	78,200 *						50	59,000 *					
55	72,700 *						55	59,000 *					
60	67,900 *						60	59,000 *					
65	63,700 *						65	59,000 *					
70	59,900 *						70	59,000 *					
75	56,600 *	67,200 *					75	56,000 *	59,000 *				
80	53,500 *	63,000 *					80	53,100 *	59,000 *				
85	50,900 *	59,300 *					85	50,200 *	58,800 *				
90	48,500 *	56,000 *					90	47,800 *	55,300 *				
95	46,300 *	52,900 *					95	45,600 *	52,400 *				
100	44,000 *	50,200 *	45,400				100	43,600 *	49,600 *				
110	39,000 *	44,900	40,100				110	39,000 *	44,500	39,600			
120	32,800 *	40,100	35,900				120	34,100 *	39,900	35,500			
130		36,300	32,400	28,400			130	28,600 *	35,900	31,900	28,000		
140			29,300	25,700			140		32,600	28,800	25,300		
150			26,900	23,500	19,600		150			26,400	23,100		
160				21,600	17,800		160			24,200	21,100	17,100	
170				19,800	16,000	12,500	170				19,400	15,400	
180					14,700	11,200	180				17,800	14,100	10,500
190						10,100	190					12,700	9,400
200						9,200	200						8,500
210							210						7,700

190' Boom							190' Boom						
Load Radius (ft.)	130 ft Jib						Load Radius (ft.)	140 ft Jib					
	Boom Angle (deg.)							Boom Angle (deg.)					
	88	83	78	73	68	63		88	83	78	73	68	63
55	59,000 *						55	58,600 *					
60	59,000 *						60	58,000 *					
65	59,000 *						65	57,300 *					
70	59,000 *						70	55,500 *					
75	55,700 *						75	52,400 *					
80	52,600 *	59,000 *					80	49,800 *					
85	49,800 *	58,400 *					85	47,400 *	54,900 *				
90	47,400 *	54,900 *					90	44,900 *	52,000 *				
95	45,200 *	52,000 *					95	42,900 *	49,300 *				
100	42,900 *	49,100 *					100	41,000 *	46,900 *				
110	39,000 *	44,300	39,400				110	37,700 *	42,700 *	39,000			
120	33,900 *	39,600	35,000				120	33,700 *	39,200 *	34,600			
130	29,900 *	35,700	31,500				130	29,700 *	35,700	31,000			
140	25,300 *	32,400	28,600	24,900			140	26,400 *	32,400	28,200	25,100		
150		28,800 *	26,200	22,700			150	22,200 *	29,700	25,700	22,700		
160			24,000	20,700	16,700		160		26,200 *	23,500	20,700		
170			22,000	18,900	14,900		170			21,600	18,900	14,300	
180				17,400	13,600		180			20,000	17,400	13,000	
190				15,800	12,300	9,000	190				15,800	11,600	9,000
200					11,200	8,100	200					10,500	7,900
210						7,200	210					9,700	7,200
220						6,600	220						6,300

CK2500-II Luffing Jib Rating Loads in Pounds

15 Counterweights + 2 Low Weights

Refer to notes page 8

190' Boom							190' Boom						
Load Radius (ft.)	150 ft Jib						Load Radius (ft.)	160 ft Jib					
	Boom Angle (deg.)							Boom Angle (deg.)					
	88	83	78	73	68	63		88	83	78	73	68	63
60	52,000 *						60	44,900 *					
65	48,900 *						65	42,300 *					
70	46,300 *						70	39,900 *					
75	43,600 *						75	37,700 *					
80	41,400 *						80	35,500 *					
85	39,400 *						85	33,700 *					
90	37,400 *	44,700 *					90	31,900 *	38,300 *				
95	35,700 *	42,300 *					95	30,400 *	36,300 *				
100	34,100 *	40,100 *					100	29,100 *	34,300 *				
110	31,300 *	36,600 *					110	26,400 *	31,000 *				
120	28,800 *	33,200 *	35,000				120	24,200 *	28,200 *	33,200 *			
130	26,600 *	30,600 *	31,500				130	22,200 *	25,700 *	30,200 *			
140	24,900 *	28,200 *	28,600				140	20,700 *	23,800 *	27,300 *			
150	23,300 *	26,200 *	26,000	22,700			150	19,100 *	21,800 *	25,100 *	22,000		
160	20,700 *	24,400 *	23,800	20,700			160	17,800 *	20,200 *	23,100 *	20,000		
170		23,100 *	22,000	18,700	14,700		170		18,900 *	21,300 *	18,300		
180			20,200	17,100	13,400		180		17,600 *	19,800	16,500	12,700	
190			18,700	15,600	12,100		190			18,300	15,200	11,400	
200				14,300	11,000	7,900	200			16,900	13,800	10,300	
210					10,100	7,000	210				12,700	9,400	
220					9,200	6,100	220					8,500	
230							230					7,700	

190' Boom							190' Boom						
Load Radius (ft.)	170 ft Jib						Load Radius (ft.)	170 ft Jib					
	Boom Angle (deg.)							Boom Angle (deg.)					
	88	83	78	73	68	63		88	83	78	73	68	63
65	37,700 *												
70	35,500 *												
75	33,200 *												
80	31,500 *												
85	29,700 *												
90	28,200 *												
95	26,900 *	32,100 *											
100	25,500 *	30,400 *											
110	23,100 *	27,300 *											
120	21,100 *	24,600 *											
130	19,400 *	22,400 *	26,400 *										
140	17,800 *	20,500 *	24,000 *										
150	16,300 *	18,900 *	21,800 *										
160	15,200 *	17,400 *	20,000 *	19,600									
170	14,100 *	16,000 *	18,500 *	17,800									
180		14,900 *	16,900 *	16,000	12,300								
190		13,800 *	15,600 *	14,700	11,000								
200			14,700 *	13,400	9,900								
210			13,600 *	12,300	9,000								
220				11,200	8,100								
230					7,200								
240					6,600								

CK2500-II Luffing Jib Rating Loads in Pounds

15 Counterweights + 2 Low Weights

Refer to notes page 8

200' Boom							200' Boom						
Load Radius (ft.)	100 ft Jib						Load Radius (ft.)	110 ft Jib					
	Boom Angle (deg.)							Boom Angle (deg.)					
	88	83	78	73	68	63		88	83	78	73	68	63
45	74,700 *						45	59,000 *					
50	69,200 *						50	59,000 *					
55	64,100 *						55	59,000 *					
60	59,900 *						60	59,000 *					
65	56,200 *						65	56,000 *					
70	52,600 *	63,900 *					70	52,400 *					
75	49,800 *	59,700 *					75	49,600 *	59,000 *				
80	47,100 *	55,700 *					80	46,700 *	55,500 *				
85	44,700 *	52,400 *					85	44,500 *	52,200 *				
90	42,500 *	49,300 *					90	42,300 *	49,100 *				
95	40,500 *	46,700 *	47,600				95	40,300 *	46,500 *				
100	39,000 *	44,300 *	44,500				100	38,300 *	44,000 *	44,500			
110	36,100 *	40,100 *	39,400				110	35,500 *	39,900 *	39,200			
120		36,800 *	35,200	30,600			120	33,000 *	36,300 *	35,000			
130			31,700	27,500			130		33,500 *	31,700	27,500		
140			28,800	24,900			140			28,600	24,900		
150				22,700	18,300		150			26,200	22,700	18,000	
160				20,700	16,500		160				20,700	16,300	
170					14,900	11,000	170				18,900	14,700	
180					13,600	9,900	180					13,400	9,700
190						8,800	190					12,300	8,800
200							200						7,900

200' Boom							200' Boom						
Load Radius (ft.)	120 ft Jib						Load Radius (ft.)	130 ft Jib					
	Boom Angle (deg.)							Boom Angle (deg.)					
	88	83	78	73	68	63		88	83	78	73	68	63
50	59,000 *						50	59,000 *					
55	59,000 *						55	59,000 *					
60	59,000 *						60	58,800 *					
65	55,300 *						65	54,900 *					
70	52,000 *						70	51,500 *					
75	48,900 *						75	48,500 *					
80	46,300 *	53,300 *					80	45,800 *	52,900 *				
85	43,800 *	50,200 *					85	43,400 *	50,000 *				
90	41,600 *	47,400 *					90	41,200 *	47,100 *				
95	39,600 *	44,900 *					95	39,200 *	44,500 *				
100	37,900 *	42,500 *					100	37,200 *	42,300 *				
110	34,600 *	38,500 *	38,800				110	34,100 *	38,100 *	38,500			
120	31,900 *	35,200 *	34,600				120	31,500 *	34,800 *	34,300			
130	29,100 *	32,400 *	31,300	27,500			130	29,300 *	31,900 *	30,800			
140		30,200 *	28,200	24,900			140	25,500 *	29,500 *	28,000	24,400		
150			25,700	22,700			150		27,500 *	25,500	22,200		
160			23,500	20,700	15,600		160			23,300	20,200		
170				18,900	14,100		170			21,300	18,500	13,600	
180				17,100	12,700	9,700	180				16,900	12,300	
190					11,600	8,500	190				15,400	11,000	8,100
200					10,500	7,700	200					10,100	7,200
210						6,800	210						

CK2500-II Luffing Jib Rating Loads in Pounds

15 Counterweights + 2 Low Weights

Refer to notes page 8

200' Boom							200' Boom						
Load Radius (ft.)	140 ft Jib						Load Radius (ft.)	150 ft Jib					
	Boom Angle (deg.)							Boom Angle (deg.)					
	88	83	78	73	68	63		88	83	78	73	68	63
55	56,400 *						55						
60	55,800 *						60	50,700 *					
65	54,400 *						65	49,100 *					
70	51,100 *						70	46,300 *					
75	48,000 *						75	43,800 *					
80	45,400 *						80	41,600 *					
85	42,900 *	49,300 *					85	39,400 *					
90	40,700 *	46,500 *					90	37,700 *	45,200 *				
95	38,500 *	44,000 *					95	35,900 *	42,700 *				
100	36,800 *	41,600 *					100	34,100 *	40,700 *				
110	33,500 *	37,700 *					110	31,300 *	36,800 *				
120	30,800 *	34,300 *	33,900				120	28,800 *	33,700 *	34,100			
130	28,400 *	31,500 *	30,400				130	26,900 *	30,800 *	30,800			
140	26,400 *	29,100 *	27,500	24,000			140	24,900 *	28,400 *	28,000			
150	22,400 *	26,900 *	25,100	21,800			150	23,300 *	26,400 *	25,300	21,600		
160		25,100 *	22,900	19,600			160	20,900 *	24,600 *	23,300	19,400		
170			21,100	17,800	13,000		170		23,100 *	21,300	17,600		
180			19,400	16,300	11,600		180			19,600	16,000	12,100	
190				14,900	10,300		190			18,300	14,700	10,800	
200				13,600	9,400		200				13,400	9,900	
210					8,500		210				12,300	8,800	
220							220					8,100	

200' Boom							200' Boom						
Load Radius (ft.)	160 ft Jib						Load Radius (ft.)	170 ft Jib					
	Boom Angle (deg.)							Boom Angle (deg.)					
	88	83	78	73	68	63		88	83	78	73	68	63
60	45,200 *						60						
65	42,300 *						65	37,900 *					
70	39,900 *						70	35,500 *					
75	37,700 *						75	33,500 *					
80	35,700 *						80	31,500 *					
85	33,700 *						85	29,900 *					
90	32,100 *						90	28,200 *					
95	30,400 *	36,800 *					95	26,900 *	32,600 *				
100	29,100 *	34,800 *					100	25,500 *	30,800 *				
110	26,400 *	31,300 *					110	23,100 *	27,700 *				
120	24,200 *	28,400 *					120	21,100 *	25,100 *				
130	22,200 *	26,000 *	30,400				130	19,400 *	22,700 *	27,100 *			
140	20,700 *	23,800 *	27,500				140	17,800 *	20,700 *	24,400 *			
150	19,100 *	22,000 *	24,900	20,900			150	16,300 *	18,900 *	22,200 *			
160	17,800 *	20,500 *	22,900	18,900			160	15,200 *	17,400 *	20,200 *	18,500		
170	16,700 *	18,900 *	20,900	16,900			170	14,100 *	16,000 *	18,700 *	16,700		
180		17,800 *	19,400	15,400	11,400		180		14,900 *	17,100 *	14,900		
190			17,800	14,100	10,100		190		13,800 *	15,800 *	13,600	9,700	
200			16,500	12,700	9,200		200			14,700 *	12,500	8,800	
210				11,600	8,300		210			13,800 *	11,400	7,900	
220				10,800	7,400		220				10,300	7,000	
230					6,600		230				9,400	6,100	

Rated Loads in Pounds for CK2500-II Crane Boom with Luffing Jib Attached but not Used

LUFFING JIB ATTACHED TO BOOM AT 23 DEGREE OFFSET ANGLE

15 Counterweights + 2 Low Weights

70' Boom												
Load Radius (ft.)	Boom Angle (deg)	Jib Length (ft)										
		70	80	90	100	110	120	130	140	150	160	170
20.5	80.6	200,000	200,000	200,000	200,000	200,000	200,000	200,000	200,000	200,000	200,000	200,000
22	79.2	200,000	200,000	200,000	200,000	200,000	200,000	200,000	200,000	200,000	200,000	200,000
24	77.5	200,000	200,000	200,000	200,000	200,000	200,000	200,000	200,000	200,000	200,000	200,000
26	75.9	200,000	200,000	200,000	200,000	200,000	200,000	200,000	200,000	200,000	200,000	200,000
28	74.1	200,000	200,000	200,000	200,000	200,000	200,000	200,000	196,200	194,200	188,500	183,200
30	72.4	200,000	200,000	200,000	197,500	194,200	190,700	186,300	181,000	179,200	173,500	168,600
32	70.6	196,000	191,800	188,000	183,600	180,500	177,000	172,800	167,500	165,800	160,500	155,600
34	68.8	183,200	179,000	175,500	171,300	168,200	164,900	160,700	155,600	153,900	148,800	144,200
36	67.0	168,900	164,900	161,600	157,400	154,300	151,000	147,000	142,200	140,400	135,600	130,900
38	65.2	154,100	150,100	146,800	142,600	140,000	136,700	132,700	128,100	126,300	121,400	117,000
40	63.3	141,100	137,300	134,000	130,000	127,400	124,100	120,300	115,700	113,900	109,300	104,900
42	61.4	129,600	126,100	122,800	118,800	116,200	113,100	109,300	104,900	103,100	98,500	94,300
44	59.4	119,900	116,200	113,100	109,300	106,700	103,600	100,100	95,600	93,900	89,300	85,300
46	57.4	111,100	107,600	104,500	100,700	98,300	95,200	91,700	87,300	85,700	81,100	77,100
48	55.4	103,400	99,800	97,000	93,200	90,800	87,700	84,200	80,000	78,400	74,000	70,100
50	53.3	96,300	92,800	89,900	86,400	84,000	81,100	77,600	73,600	71,800	67,600	63,700
55	47.7	81,300	78,200	75,400	72,100	69,800	66,800	63,700	59,700	57,900	54,000	50,200
60	41.4	69,600	66,500	63,900	60,600	58,600	55,700	52,600	48,900	47,100	43,200	39,900
80' Boom												
Load Radius (ft.)	Boom Angle (deg)	Jib Length (ft)										
		70	80	90	100	110	120	130	140	150	160	170
22	80.6	200,000	200,000	200,000	200,000	200,000	200,000	200,000	200,000	200,000	200,000	200,000
24	79.1	200,000	200,000	200,000	200,000	200,000	200,000	200,000	200,000	200,000	200,000	200,000
26	77.7	200,000	200,000	200,000	200,000	200,000	200,000	200,000	200,000	200,000	200,000	200,000
28	76.2	200,000	200,000	200,000	200,000	200,000	200,000	200,000	197,300	195,500	190,000	184,900
30	74.7	200,000	200,000	200,000	197,700	194,700	191,300	186,900	181,900	180,300	175,000	170,200
32	73.2	195,800	191,800	188,300	183,800	180,800	177,700	173,500	168,600	166,900	161,800	157,200
34	71.6	183,000	179,000	175,700	171,500	168,400	165,300	161,400	156,500	155,000	150,100	145,500
36	70.1	169,300	165,300	162,000	158,000	155,200	152,100	148,100	143,500	142,000	137,300	132,900
38	68.5	154,300	150,600	147,500	143,300	140,600	137,500	133,800	129,400	127,800	123,200	119,000
40	66.9	141,300	137,800	134,700	130,700	128,100	125,200	121,400	117,000	115,500	111,100	106,900
42	65.3	130,000	126,300	123,400	119,500	117,000	114,200	110,400	106,200	104,700	100,300	96,300
44	63.7	120,100	116,600	113,500	109,800	107,300	104,500	100,900	96,700	95,400	91,000	87,000
46	62.1	111,300	107,800	104,900	101,200	99,000	96,100	92,600	88,600	87,000	82,900	78,900
48	60.4	103,400	99,800	97,200	93,400	91,200	88,400	85,100	81,100	79,600	75,400	71,600
50	58.6	96,300	93,000	90,100	86,600	84,400	81,500	78,200	74,300	72,900	68,700	65,200
55	54.2	81,500	78,400	75,800	72,300	70,300	67,400	64,300	60,600	59,300	55,300	51,800
60	49.4	69,600	66,500	64,100	60,800	58,800	56,200	53,300	49,600	48,200	44,500	41,200
65	44.2	59,900	57,100	54,600	51,500	49,600	46,900	44,300	40,700	39,200	35,700	32,400
90' Boom												
Load Radius (ft.)	Boom Angle (deg)	Jib Length (ft)										
		70	80	90	100	110	120	130	140	150	160	170
24	80.4	200,000	200,000	200,000	200,000	200,000	200,000	200,000	200,000	200,000	200,000	200,000
26	79.1	200,000	200,000	200,000	200,000	200,000	200,000	200,000	200,000	200,000	200,000	200,000
28	77.8	200,000	200,000	200,000	200,000	200,000	200,000	200,000	197,700	196,200	190,900	186,100
30	76.4	200,000	200,000	200,000	198,000	195,100	191,800	187,600	182,700	181,200	176,100	171,500
32	75.1	195,800	191,800	188,500	184,100	181,200	178,100	174,100	169,300	168,000	162,900	158,500
34	73.8	183,000	179,000	175,700	171,700	168,900	166,000	162,000	157,400	156,100	151,200	146,800
36	72.4	169,300	165,500	162,500	158,500	155,800	152,800	149,000	144,600	143,300	138,600	134,500
38	71.1	154,500	150,800	147,700	143,900	141,300	138,400	134,700	130,500	129,200	124,500	120,600
40	69.7	141,500	138,000	134,900	131,100	128,700	125,900	122,300	118,100	116,800	112,400	108,400
42	68.3	130,000	126,500	123,700	119,900	117,500	114,800	111,300	107,100	106,000	101,600	97,900
44	66.9	120,100	116,800	113,900	110,200	108,000	105,100	101,800	97,900	96,500	92,300	88,600
46	65.5	111,300	108,000	105,100	101,600	99,400	96,700	93,400	89,500	88,200	84,200	80,400
48	64.0	103,400	100,100	97,400	93,900	91,700	89,000	85,900	82,000	80,700	76,700	73,200
50	62.6	96,300	93,200	90,400	87,000	84,800	82,200	79,100	75,400	74,000	70,100	66,500
55	58.8	81,500	78,400	76,000	72,700	70,500	68,100	65,000	61,500	60,100	56,400	53,100
60	54.9	69,600	66,800	64,300	61,000	59,000	56,600	53,800	50,200	49,100	45,400	42,300
65	50.7	59,900	57,100	54,600	51,800	49,800	47,400	44,700	41,200	40,100	36,600	33,500
70	46.3	52,000	49,100	46,900	44,100	42,300	39,900	37,200	33,900	32,800	29,300	26,400
75	41.4	45,400	42,700	40,500	37,700	35,900	33,700	31,000	28,000	26,600	23,300	20,500



Rated Loads in Pounds for CK2500-II Crane Boom with Luffing Jib Attached but not Used

LUFFING JIB ATTACHED TO BOOM AT 23 DEGREE OFFSET ANGLE

15 Counterweights + 2 Low Weights

100' Boom												
Load Radius (ft.)	Boom Angle (deg)	Jib Length (ft)										
		70	80	90	100	110	120	130	140	150	160	170
26	80.2	200,000	200,000	200,000	200,000	200,000	200,000	200,000	200,000	200,000	200,000	200,000
28	79.0	200,000	200,000	200,000	200,000	200,000	200,000	200,000	198,400	197,100	191,800	187,200
30	77.8	200,000	200,000	200,000	200,000	198,200	195,100	192,200	188,000	183,200	181,900	176,800
32	76.7	195,500	191,800	188,300	184,300	181,400	178,300	174,600	169,700	168,600	163,800	159,400
34	75.5	182,700	179,000	175,700	171,700	169,100	166,200	162,500	157,800	156,700	151,900	147,700
36	74.3	169,300	165,800	162,700	158,700	154,100	153,400	149,700	145,300	144,200	139,500	135,600
38	73.0	154,300	150,800	147,700	143,900	141,300	138,600	135,100	130,900	129,800	125,400	121,400
40	71.8	141,300	137,800	134,900	131,100	128,700	126,100	122,800	118,600	117,500	113,100	109,300
42	70.6	130,000	126,700	123,900	120,300	117,900	115,300	112,000	107,800	106,700	102,500	99,000
44	69.4	119,900	116,600	113,900	110,400	108,000	105,600	102,300	98,300	97,200	93,000	89,500
46	68.1	111,100	108,000	105,100	101,800	99,400	97,000	93,900	89,900	88,800	84,800	81,300
48	66.8	103,100	100,100	97,400	93,900	91,700	89,300	86,200	82,400	81,300	77,300	73,800
50	65.6	96,100	93,000	90,400	87,000	84,800	82,400	79,300	75,600	74,700	70,700	67,400
55	62.3	81,100	78,200	75,600	72,500	70,300	68,100	65,200	61,500	60,600	56,800	53,500
60	58.9	69,400	66,500	64,100	61,000	59,000	56,800	54,000	50,700	49,600	46,000	42,900
65	55.4	59,700	56,800	54,400	51,500	49,800	47,400	44,700	41,400	40,500	37,000	34,100
70	51.7	51,800	48,900	46,700	43,800	42,100	39,900	37,200	34,100	33,000	29,700	26,900
75	47.8	44,900	42,300	40,100	27,400	35,700	33,500	31,000	28,000	26,900	23,500	20,900
80	43.7	39,200	36,600	34,600	31,700	30,200	28,000	25,500	22,700	21,600	18,500	15,600

110' Boom												
Load Radius (ft.)	Boom Angle (deg)	Jib Length (ft)										
		70	80	90	100	110	120	130	140	150	160	170
28	80.0	200,000	200,000	200,000	200,000	200,000	200,000	200,000	198,800	197,500	192,400	187,800
30	79.0	200,000	200,000	200,000	198,400	195,300	192,400	188,500	183,600	182,500	177,700	173,300
32	77.9	195,300	191,600	188,300	184,300	181,400	178,600	174,800	170,200	169,100	164,200	160,000
34	76.8	182,700	179,000	175,900	171,900	169,300	166,600	162,900	158,500	157,400	152,800	148,800
36	75.7	169,100	165,300	162,200	158,500	155,800	153,400	149,700	145,500	144,400	140,000	136,000
38	74.6	154,100	150,600	147,700	143,900	141,300	138,900	135,300	131,100	130,300	125,900	122,100
40	73.5	141,100	137,800	134,900	131,100	128,700	126,300	123,000	118,800	117,900	113,700	110,000
42	72.4	129,600	126,300	123,700	120,100	117,700	115,300	112,000	108,000	107,100	102,900	99,400
44	71.3	119,900	116,600	113,700	110,400	108,000	105,800	102,500	98,500	97,600	93,700	90,100
46	70.2	111,100	107,800	105,100	101,800	99,400	97,200	94,100	90,400	89,300	85,500	82,000
48	69.1	103,100	99,800	97,200	93,900	91,700	89,500	86,400	82,600	81,800	78,000	74,700
50	67.9	95,900	92,800	90,400	87,000	84,800	82,600	79,800	76,000	75,100	71,400	68,100
55	65.1	80,900	78,000	75,600	72,500	70,300	68,300	65,400	61,900	61,000	57,500	54,200
60	62.1	69,000	66,100	63,700	60,800	58,800	56,600	54,000	50,700	49,800	46,300	43,400
65	59.0	59,300	56,400	54,200	51,300	49,300	47,400	44,700	41,400	40,500	37,200	34,300
70	55.8	51,100	48,500	46,300	43,400	41,600	39,600	37,200	33,900	33,000	29,900	27,100
75	52.5	44,500	41,800	39,600	37,000	35,200	33,200	30,800	27,700	26,900	23,800	21,100
80	49.1	38,800	36,100	34,100	31,500	29,900	28,000	25,500	22,700	21,800	18,700	16,000
85	45.4	33,700	31,300	29,300	26,900	25,300	23,100	20,900	18,000	17,100	14,100	
90	41.4	29,500	27,100	25,100	22,700	21,100	18,100	16,900	14,300	13,200		

120' Boom												
Load Radius (ft.)	Boom Angle (deg)	Jib Length (ft)										
		70	80	90	100	110	120	130	140	150	160	170
30	79.9	200,000	200,000	200,000	198,200	195,100	192,400	188,500	183,800	182,700	177,900	173,700
32	78.9	195,100	191,600	188,300	184,300	181,400	178,800	175,000	170,600	169,500	164,900	160,700
34	77.9	182,300	178,800	175,700	171,700	169,100	166,600	162,900	158,500	157,600	153,200	149,200
36	77.0	169,100	165,500	162,500	158,700	156,300	153,900	150,300	146,100	145,000	140,800	136,900
38	76.0	153,900	150,600	147,700	143,900	141,500	139,100	135,800	131,600	130,700	126,500	122,800
40	75.0	141,100	137,800	134,900	131,400	128,900	126,500	123,200	119,200	118,400	114,400	110,600
42	74.0	129,600	126,300	123,400	120,100	117,700	115,500	112,200	108,400	107,600	103,600	100,100
44	73.0	119,700	116,400	113,700	110,400	108,200	105,800	102,700	99,000	98,100	94,300	90,800
46	71.9	110,900	107,800	105,100	101,800	99,600	97,400	94,300	90,600	89,900	85,900	82,600
48	70.9	102,900	99,800	97,200	93,900	91,900	89,700	86,600	83,100	82,200	78,400	75,400
50	69.9	95,900	92,800	90,400	87,000	85,100	82,900	80,000	76,500	75,600	71,800	68,700
55	67.3	80,900	77,800	75,600	72,500	70,500	68,300	65,700	62,100	61,500	57,900	54,900
60	64.6	68,700	66,100	63,700	60,800	58,800	56,800	54,200	50,900	50,200	46,900	43,800
65	61.9	59,000	56,400	54,000	51,300	49,300	47,400	44,900	41,600	41,000	37,700	35,000
70	59.1	50,900	48,200	46,300	43,400	41,600	39,600	37,200	34,100	33,500	30,400	27,500
75	56.2	44,300	41,600	39,600	36,800	35,200	33,200	30,800	28,000	27,300	24,200	21,600
80	53.2	38,300	35,900	33,700	31,300	29,500	27,700	25,300	22,400	21,800	18,700	16,300
85	50.1	33,500	31,000	29,100	26,600	25,100	23,100	20,900	18,000	17,400	14,500	11,900
90	46.8	29,300	26,900	24,900	22,400	20,900	19,100	16,900	14,100	13,400		
95	43.3	25,300	22,900	21,100	18,700	17,400	15,400	13,200	10,500			



Rated Loads in Pounds for CK2500-II Crane Boom with Luffing Jib Attached but not Used

LUFFING JIB ATTACHED TO BOOM AT 23 DEGREE OFFSET ANGLE

15 Counterweights + 2 Low Weights

130' Boom												
Load Radius (ft.)	Boom Angle (deg)	Jib Length (ft)										
		70	80	90	100	110	120	130	140	150	160	170
32	79.8	194,900	191,100	188,000	184,100	181,200	178,800	175,000	170,600	169,700	165,100	160,900
34	78.9	182,100	178,300	175,200	171,500	168,900	166,400	162,900	158,700	157,800	153,400	149,400
36	78.0	168,600	165,300	162,200	158,500	156,100	153,600	150,300	146,100	145,300	141,100	137,300
38	77.1	153,900	150,300	147,500	143,900	141,500	139,300	136,000	131,800	131,100	127,000	123,200
40	76.2	140,600	137,300	134,500	131,100	128,700	126,500	123,200	119,200	118,600	114,600	111,100
42	75.2	129,400	126,300	123,400	120,100	117,700	115,700	112,400	108,700	108,000	104,000	100,500
44	74.3	119,200	116,200	113,500	110,200	108,000	105,800	102,700	99,000	98,300	94,500	91,200
46	73.4	110,400	107,300	104,900	101,600	99,400	97,400	94,300	90,600	89,900	86,200	82,900
48	72.5	102,500	99,600	97,000	93,900	91,700	89,700	86,600	83,100	82,400	78,900	75,600
50	71.5	95,400	92,600	89,900	86,800	84,800	82,900	80,000	76,500	75,800	72,300	69,000
55	69.2	80,400	77,600	75,100	72,300	70,300	68,300	65,700	62,100	61,700	58,200	55,100
60	66.7	68,500	65,700	63,500	60,600	58,600	56,800	54,200	50,900	50,400	47,100	44,100
65	64.3	58,600	56,000	53,800	50,900	49,100	47,400	44,900	41,800	41,200	37,900	35,200
70	61.8	50,700	48,000	45,800	43,200	41,400	39,600	37,200	34,100	33,500	30,400	27,700
75	59.2	43,800	41,200	39,200	36,600	35,000	33,200	30,800	28,000	27,300	24,200	21,600
80	56.5	37,900	35,500	33,500	30,800	29,300	27,500	25,300	22,400	21,800	18,900	16,300
85	53.8	33,000	30,600	28,600	26,200	24,600	22,900	20,700	18,000	17,400	14,500	12,100
90	50.9	28,600	26,400	24,400	22,000	20,700	18,700	16,700	13,800	13,200		
95	47.9	24,900	22,400	20,700	18,300	13,900	15,200	13,000				
100	44.8	21,600	19,100	17,400	15,200	13,800	12,100					
105	41.4	18,500	16,300	14,500	12,300	11,000						

140' Boom												
Load Radius (ft.)	Boom Angle (deg)	Jib Length (ft)										
		70	80	90	100	110	120	130	140	150	160	170
32	80.5	194,400	190,700	187,600	183,600	182,500	178,600	174,800	170,400	169,700	165,100	161,100
34	79.7	181,600	178,100	175,000	171,300	170,200	166,200	162,700	158,500	157,800	153,400	149,700
36	78.9	168,600	165,300	162,200	158,700	157,600	153,900	150,600	146,400	145,700	141,500	137,800
38	78.0	153,900	150,600	147,700	144,200	143,100	139,500	136,200	132,300	131,600	127,400	123,900
40	77.2	140,600	137,300	134,700	131,100	130,300	126,700	123,700	119,700	119,000	115,100	111,500
42	76.3	129,400	126,300	123,700	120,100	119,500	115,900	112,800	109,100	108,400	104,500	101,200
44	75.5	119,500	116,200	113,500	110,200	109,500	106,000	103,100	99,400	98,700	95,000	91,700
46	74.6	110,600	107,600	104,900	101,600	100,900	97,600	94,500	91,000	90,400	86,800	83,500
48	73.8	102,500	99,600	97,000	93,900	93,200	89,900	87,000	83,500	82,900	79,300	76,200
50	72.9	95,400	92,600	90,100	87,000	86,200	83,100	80,200	76,700	76,200	72,700	69,600
55	70.7	80,200	77,300	75,100	72,100	71,400	68,300	65,700	62,400	61,900	58,400	55,500
60	68.5	68,300	65,400	63,200	60,400	59,700	56,800	54,200	51,100	50,700	47,400	44,500
65	66.3	59,600	56,000	53,800	51,100	50,400	47,600	45,200	42,100	41,600	38,300	35,700
70	64.0	50,400	47,800	45,600	42,900	42,300	39,600	37,200	34,300	33,700	30,800	28,200
75	61.6	43,600	41,000	39,000	36,300	35,900	33,000	30,800	28,000	27,500	24,400	22,000
80	59.2	37,700	35,200	33,200	30,600	30,200	27,500	25,300	22,400	22,000	19,100	16,500
85	56.8	32,800	30,400	28,400	26,000	25,300	22,900	20,700	18,000	17,400	14,700	12,300
90	54.2	28,400	26,000	24,200	21,800	21,100	18,700	16,500	13,800	13,400		
95	51.6	24,400	22,200	20,200	18,000	17,400	14,900	13,000				
100	48.9	21,100	18,900	17,100	14,700	14,300	11,900					
105	46.0	18,000	15,800	14,100	11,900	11,200						
110	43.0	15,400	13,200	11,600								

150' Boom												
Load Radius (ft.)	Boom Angle (deg)	Jib Length (ft)										
		70	80	90	100	110	120	130	140	150	160	170
34	80.4	181,200	177,700	175,900	172,400	170,000	166,200	162,700	158,500	157,800	153,400	149,700
36	79.6	168,600	165,100	163,600	160,000	157,800	154,100	150,600	146,600	145,900	141,700	138,200
38	78.8	153,400	150,100	148,600	145,300	143,100	139,300	136,000	132,300	131,600	127,600	124,100
40	78.0	140,400	137,300	135,800	132,500	130,300	126,700	123,700	119,900	119,200	115,500	112,000
42	77.3	129,200	125,900	124,500	121,200	119,200	115,700	112,600	108,900	108,400	104,700	101,400
44	76.5	119,000	115,900	114,400	111,300	109,300	106,000	102,900	99,400	98,700	95,200	91,900
46	75.7	110,200	107,100	105,800	102,700	100,700	97,400	94,500	91,000	90,600	86,800	83,700
48	74.9	102,300	99,200	97,900	94,800	93,000	89,700	86,800	83,500	82,900	79,300	76,200
50	74.1	95,200	92,100	90,800	87,900	85,900	82,900	80,200	76,700	76,200	72,700	69,800
55	72.1	80,200	77,300	76,000	73,200	71,400	68,300	65,900	62,600	62,100	58,800	56,000
60	70.0	68,100	65,400	64,100	61,500	59,700	56,800	54,400	51,300	50,900	47,600	44,900
65	68.0	58,400	55,700	54,400	51,800	50,200	47,400	44,900	42,100	41,600	38,500	35,900
70	65.8	50,200	47,600	46,500	43,800	42,300	39,600	37,200	34,300	33,900	31,000	28,400
75	63.7	43,200	40,700	39,600	37,000	35,700	33,000	30,600	27,700	27,500	24,400	22,000
80	61.5	37,400	35,000	33,900	31,500	30,200	27,500	25,300	22,400	22,000	19,400	16,900
85	59.3	32,400	29,900	28,800	26,600	25,100	22,700	20,500	17,800	17,400	14,700	12,300
90	57.0	28,000	25,700	24,600	22,200	20,900	18,500	16,300	13,800	13,200		
95	54.6	24,000	21,800	20,700	18,500	17,100	14,700	12,700				
100	52.2	20,700	18,500	17,400	15,200	13,800	11,400					
105	49.7	17,600	15,400	14,300	12,100	11,000						
110	47.1	14,900	12,700	11,600								
115	44.3	12,500										

Rated Loads in Pounds for CK2500-II Crane Boom with Luffing Jib Attached but not Used

LUFFING JIB ATTACHED TO BOOM AT 23 DEGREE OFFSET ANGLE

15 Counterweights + 2 Low Weights

160' Boom												
Load Radius (ft.)	Boom Angle (deg)	Jib Length (ft)										
		70	80	90	100	110	120	130	140	150	160	170
36	80.3	168,000	166,000	163,100	159,600	157,400	153,600	150,300	146,400	145,900	141,700	138,200
38	79.5	153,200	151,000	148,300	145,000	142,800	139,300	136,000	132,300	131,600	127,600	124,100
40	78.8	140,000	138,000	135,300	132,000	130,000	126,500	123,400	119,700	119,200	115,300	112,000
42	78.1	128,700	126,500	124,100	121,000	118,800	115,500	112,400	108,700	108,200	104,500	101,200
44	77.3	118,800	116,800	114,400	111,300	109,100	105,800	102,900	99,400	99,000	95,200	92,100
46	76.6	109,800	107,800	105,300	102,300	100,300	97,200	94,300	90,800	90,400	86,800	83,700
48	75.9	101,800	99,800	97,400	94,500	92,600	89,500	86,600	83,300	82,900	79,300	76,200
50	75.1	94,500	92,800	90,600	87,500	85,700	82,600	79,800	76,500	76,200	72,700	69,600
55	73.2	79,600	77,800	75,600	72,900	71,200	68,100	65,400	62,400	61,900	58,600	56,000
60	71.3	67,600	65,900	63,900	61,000	59,500	56,600	54,200	51,100	50,700	47,600	44,900
65	69.4	57,700	56,200	54,000	51,500	49,800	47,100	44,700	41,800	41,400	38,300	35,900
70	67.5	49,600	47,800	45,800	43,400	41,800	39,200	36,800	33,900	33,700	30,600	28,200
75	65.5	42,700	41,000	39,200	36,800	35,200	32,600	30,400	27,500	27,300	24,400	22,000
80	63.5	36,800	35,200	33,200	30,800	29,500	26,900	24,900	22,000	21,800	18,900	16,500
85	61.4	31,900	30,400	28,400	26,200	24,900	22,200	20,200	17,600	17,100	14,500	12,300
90	59.3	27,500	26,000	24,200	21,800	20,500	18,000	16,000	13,400	13,200		
95	57.2	23,500	22,000	20,200	18,000	16,700	14,300	12,300				
100	55.0	20,200	18,700	16,900	14,700	13,400	11,200					
105	52.7	17,100	15,400	13,800	11,600							
110	50.4	14,300	12,700	11,200								
115	48.0	11,900										
170' Boom												
Load Radius (ft.)	Boom Angle (deg)	Jib Length (ft)										
		70	80	90	100	110	120	130	140	150	160	170
38	80.2	153,900	150,800	148,100	144,600	142,400	138,900	135,800	134,000	131,600	127,600	124,100
40	79.5	140,800	137,800	135,100	132,000	129,800	126,500	123,400	121,700	119,200	115,500	112,000
42	78.8	129,400	126,500	123,900	120,800	118,800	115,300	112,400	110,600	108,400	104,700	101,400
44	78.1	119,200	116,400	113,900	110,900	108,900	105,600	102,700	101,200	98,700	95,200	92,100
46	77.4	110,400	107,600	105,100	102,300	100,300	97,000	94,300	92,600	90,400	86,800	83,700
48	76.7	102,500	99,600	97,400	94,300	92,600	89,500	86,600	85,100	82,900	79,600	76,500
50	76.0	95,400	92,600	90,400	87,500	85,500	82,600	79,800	78,200	76,200	72,900	69,800
55	74.3	80,000	77,300	75,400	72,500	70,700	67,900	65,200	63,900	61,900	58,600	55,700
60	72.5	68,100	65,400	63,500	60,800	59,000	56,400	53,800	52,400	50,400	47,400	44,700
65	70.7	58,200	55,700	53,800	51,100	49,600	46,900	44,500	43,200	41,400	38,300	35,700
70	68.9	50,000	47,600	45,800	43,200	41,600	39,000	36,800	35,500	33,700	30,800	28,400
75	67.0	43,200	41,000	39,000	36,600	35,000	32,600	30,400	29,100	27,300	24,400	22,200
80	65.2	37,200	35,000	33,000	30,800	29,300	26,900	24,600	23,300	21,800	18,900	16,700
85	63.3	32,100	29,900	28,200	25,700	24,400	22,000	19,800	18,500	16,900	14,300	12,100
90	61.3	27,700	25,500	23,800	21,600	20,200	17,800	15,800	14,300	13,000		
95	59.4	23,800	21,600	19,800	17,600	16,300	13,800	11,900	10,500			
100	57.4	20,200	18,300	16,500	14,300	13,200	10,800					
105	55.3	17,100	14,900	13,400	11,200							
110	53.2	14,500	12,300	10,800								
115	51.0	11,900										
180' Boom												
Load Radius (ft.)	Boom Angle (deg)	Jib Length (ft)										
		70	80	90	100	110	120	130	140	150	160	170
40	80.1	141,100	138,000	135,300	132,300	130,000	126,700	125,600	122,100	119,700	115,900	112,600
42	79.4	129,600	126,500	124,100	121,000	119,000	115,700	114,600	111,100	108,900	105,100	102,000
44	78.8	119,500	116,600	114,200	111,100	109,100	105,800	104,900	101,400	99,200	95,600	92,600
46	78.1	110,600	107,800	105,300	102,500	100,500	97,400	96,300	93,000	90,800	87,500	84,400
48	77.5	102,500	99,600	97,400	94,300	92,600	89,500	88,400	85,300	83,100	79,800	76,700
50	76.8	95,400	92,600	90,400	87,500	85,700	82,600	81,800	78,400	76,500	73,200	70,300
55	75.2	80,200	77,600	75,600	72,700	71,000	68,100	67,200	64,100	62,400	59,000	56,400
60	73.5	68,100	65,400	63,500	60,800	59,300	56,400	55,500	52,600	50,700	47,800	45,200
65	71.8	58,200	55,700	53,800	51,100	49,600	46,900	46,000	43,200	41,400	38,500	36,100
70	70.1	50,000	47,600	45,800	43,200	41,800	39,200	38,300	35,700	33,900	31,000	28,600
75	68.4	42,900	40,500	38,800	36,300	35,000	32,400	31,500	28,800	27,300	24,400	22,200
80	66.7	37,200	35,000	33,000	30,800	29,300	26,900	26,200	23,500	22,000	19,400	16,900
85	64.9	32,100	29,900	28,200	25,700	24,400	22,000	21,100	18,700	17,100	14,500	12,300
90	63.1	27,700	25,500	23,800	21,600	20,200	17,800	16,900	14,500	13,200		
95	61.3	23,500	21,300	19,800	17,600	16,300	14,100	13,200	10,800			
100	59.4	20,200	18,000	16,500	14,300	13,200	10,800					
105	57.5	17,100	14,900	13,400	11,200							
110	55.6	14,300	12,300	10,800								
115	53.6	11,900										



Rated Loads in Pounds for CK2500-II Crane Boom with Luffing Jib Attached but not Used

LUFFING JIB ATTACHED TO BOOM AT 23 DEGREE OFFSET ANGLE

15 Counterweights + 2 Low Weights

190' Boom												
Load Radius (ft.)	Boom Angle (deg)	Jib Length (ft)										
		70	80	90	100	110	120	130	140	150	160	170
40	80.6	141,100	138,000	135,600	132,300	130,300	128,700	125,900	122,300	119,900	116,200	112,800
42	80.0	129,600	126,700	124,300	121,200	119,000	117,500	114,800	111,300	109,100	105,300	102,300
44	79.4	119,500	116,600	114,200	111,100	109,300	107,800	105,100	101,800	99,400	95,900	92,800
46	78.8	110,600	107,800	105,600	102,500	100,700	99,200	96,500	93,200	91,200	87,700	84,600
48	78.1	102,500	99,600	97,400	94,500	92,600	91,200	88,600	85,500	83,300	80,000	77,100
50	77.5	95,400	92,600	90,400	87,500	85,700	84,400	81,800	78,700	76,700	73,400	70,500
55	76.0	80,200	77,800	75,600	72,900	71,200	69,800	67,400	64,600	62,600	59,500	56,600
60	74.4	68,100	65,400	63,500	60,800	59,300	57,900	55,700	52,900	51,100	48,000	45,400
65	72.8	58,200	55,700	53,800	51,300	49,800	48,500	46,300	43,600	41,800	38,800	36,300
70	71.2	50,000	47,600	45,800	43,400	41,800	40,500	38,500	35,900	34,100	31,300	28,800
75	69.6	42,900	40,700	38,800	36,600	35,000	33,900	31,700	29,100	27,500	24,900	22,400
80	68.0	37,200	35,000	33,200	30,800	29,500	28,200	26,200	23,800	22,200	19,600	17,400
85	66.3	31,900	29,700	28,000	25,700	24,400	23,100	21,100	18,700	17,100	14,700	12,500
90	64.6	27,500	25,300	23,500	21,300	20,000	18,900	16,900	14,500	13,200	10,500	
95	62.9	23,500	21,600	19,800	17,600	16,500	15,200	13,400	11,000			
100	61.2	20,000	17,800	16,300	14,100	13,000	11,900					
105	59.4	17,100	14,900	13,400	11,200							
110	57.6	14,100	12,100									
115	55.8	11,600										
200' Boom												
Load Radius (ft.)	Boom Angle (deg)	Jib Length (ft)										
		70	80	90	100	110	120	130	140	150	160	170
42	80.5				120,600	120,300	117,300	114,400	111,100	108,900	105,100	102,000
44	79.9				110,600	110,400	107,300	104,700	101,400	99,200	95,600	92,600
46	79.3				101,800	101,600	98,500	96,100	92,800	90,600	87,300	84,200
48	78.7				94,100	93,900	90,800	88,400	85,300	83,100	79,800	76,900
50	78.1				87,000	86,800	84,000	81,500	78,400	76,500	73,200	70,300
55	76.7				72,300	72,100	69,200	66,800	63,900	61,900	58,800	56,200
60	75.2				60,400	60,100	57,700	55,300	52,400	50,700	47,800	45,200
65	73.7				50,900	50,700	48,000	45,800	43,200	41,400	38,500	36,100
70	72.2				42,700	42,500	40,100	37,900	35,200	33,700	30,800	28,400
75	70.7				35,900	35,900	33,500	31,500	28,800	27,300	24,600	22,200
80	69.1				30,200	29,900	27,700	25,700	23,100	21,800	19,100	16,700
85	67.6				25,300	25,100	22,700	20,900	18,500	16,900	14,300	12,100
90	66.0				20,900	20,700	18,500	16,500	14,300	12,700		
95	64.4				16,900	16,700	14,500	12,700				
100	62.8				13,600	13,600	11,400					
105	61.1				10,500							

Specifications of Luffing Jib Attachments **KOBELCO**

Dimensions: ft-in (mm) - Weight: lbs (kg)

<p>Luffing Boom Tip Weight: 4,167 lbs (1,890 kg)</p>	<p>10ft (3.0 m) Insert Jib (Luffing Jib) Weight: 684 lbs (310 kg)</p>	<p>Luffing Jib Backstop Weight: 243 lbs (180 kg)</p>
<p>Luffing Taper Insert Boom Weight: 2,271 lbs (1,030 kg)</p>	<p>20ft (6.1 m) Insert Jib (Luffing Jib) Weight: 1,147 lbs (540 kg)</p>	<p>Strut Backstop (Luffing Jib) Weight: 397 lbs (180)</p>
<p>Luffing Jib Base Weight: 2,514 lbs (1,140 kg)</p>	<p>40ft (12.2 m) Insert Jib (Luffing Jib) Weight: 2,117 lbs (960 kg)</p>	<p>Aux. Sheave (Luffing Jib) Weight: 838 lbs (380 kg)</p>
<p>Luffing Jib Tip Weight: 2,580 lbs (1,170 kg)</p>	<p>Front Strut (Luffing Jib) Weight: 2,558 lbs (1,160 kg)</p>	<p>Luffing Boom Tip Assembly Weight: 13,230 lbs (6,000 kg)</p>
	<p>Rear Strut (Luffing Jib) Weight: 2,492 lbs (1,130 kg)</p>	<p>Luffing Jib Drum Weight: 3,241 lbs (1,470 kg)</p>

CK2500-II Luffing Jib

Bigge Crane and Rigging Co.

10700 Bigge Avenue
San Leandro, CA 94577
Phone: (888) 337-BIGGE or (510) 638-8100
Fax: (510) 639-4053
Email: info@bigge.com
Web site: www.bigge.com

Note: Due to our policy of continual product improvement, all designs and specifications are subject to change without advance notice. Pictures inside this publication may show machines with optional equipment. This manual and the specifications herein were prepared for the market served by Kobelco Cranes North America Inc. including North America and Latin America. Kobelco product specifications in other world markets may differ.

KOBELCO CRANES CO., LTD

Oval Court Ohsaki Mark West Bldg., 17-1, Higashigotanda 2-chome,
Shinagawa-ku, Tokyo, 141-8626 JAPAN
Tel: ++81 (0) 3-5789-2130 Fax: ++81 (0) 3-5789-3372

KOBELCO CRANES NORTH AMERICA INC.

10845 Train Court
Houston Texas 77041 U.S.A
Tel: 713-856-5755 Fax: 713-856-9072
www.kobelcocranesnorthamerica.com

