

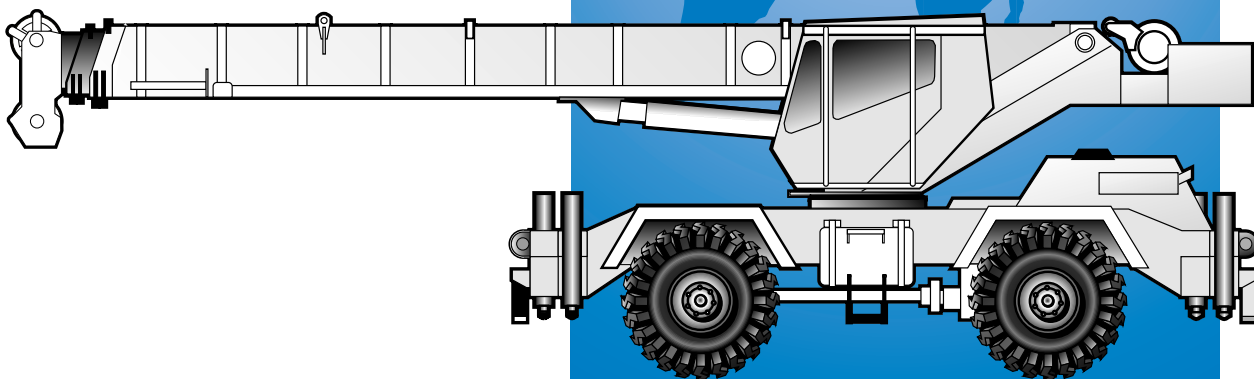

RT522B



Rough Terrain Hydraulic Crane



Dimensions

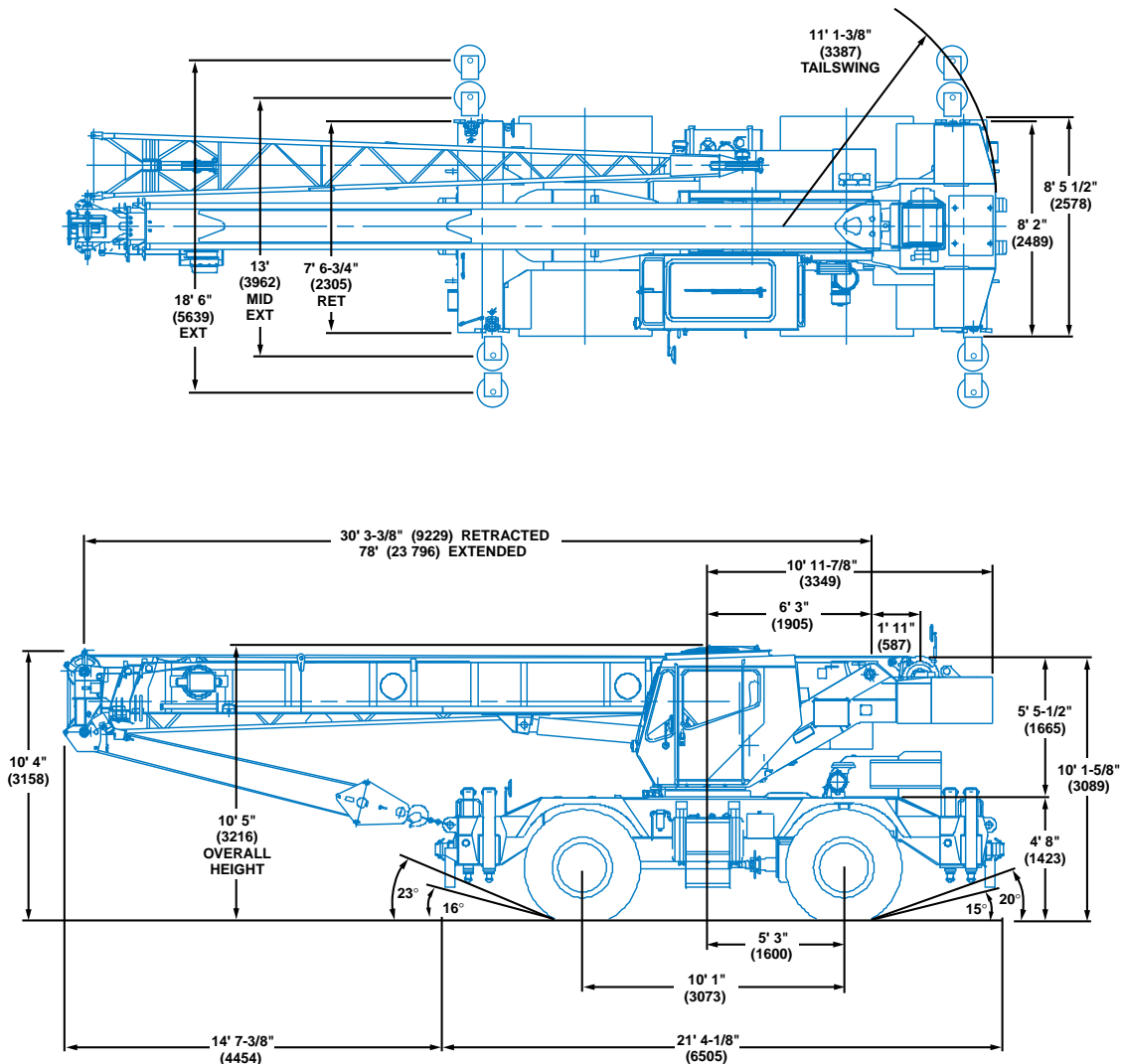

Note: () Reference dimensions in mm

- Turning Radius** 16.4'
- Front Axle Load** 21,860 lbs. (9916 kg)
- Rear Axle Load** 22,788 lbs. (10 336 kg)
- Gross Vehicle Weight** 44,648 lbs. (20 252 kg)



Working range



30 - 78 ft.
(9.2 - 23.8 m)

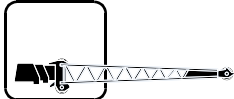

25 ft.
(7.6 m)



5,700 lbs.
(2586 kg)

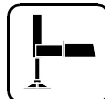

100%



360°

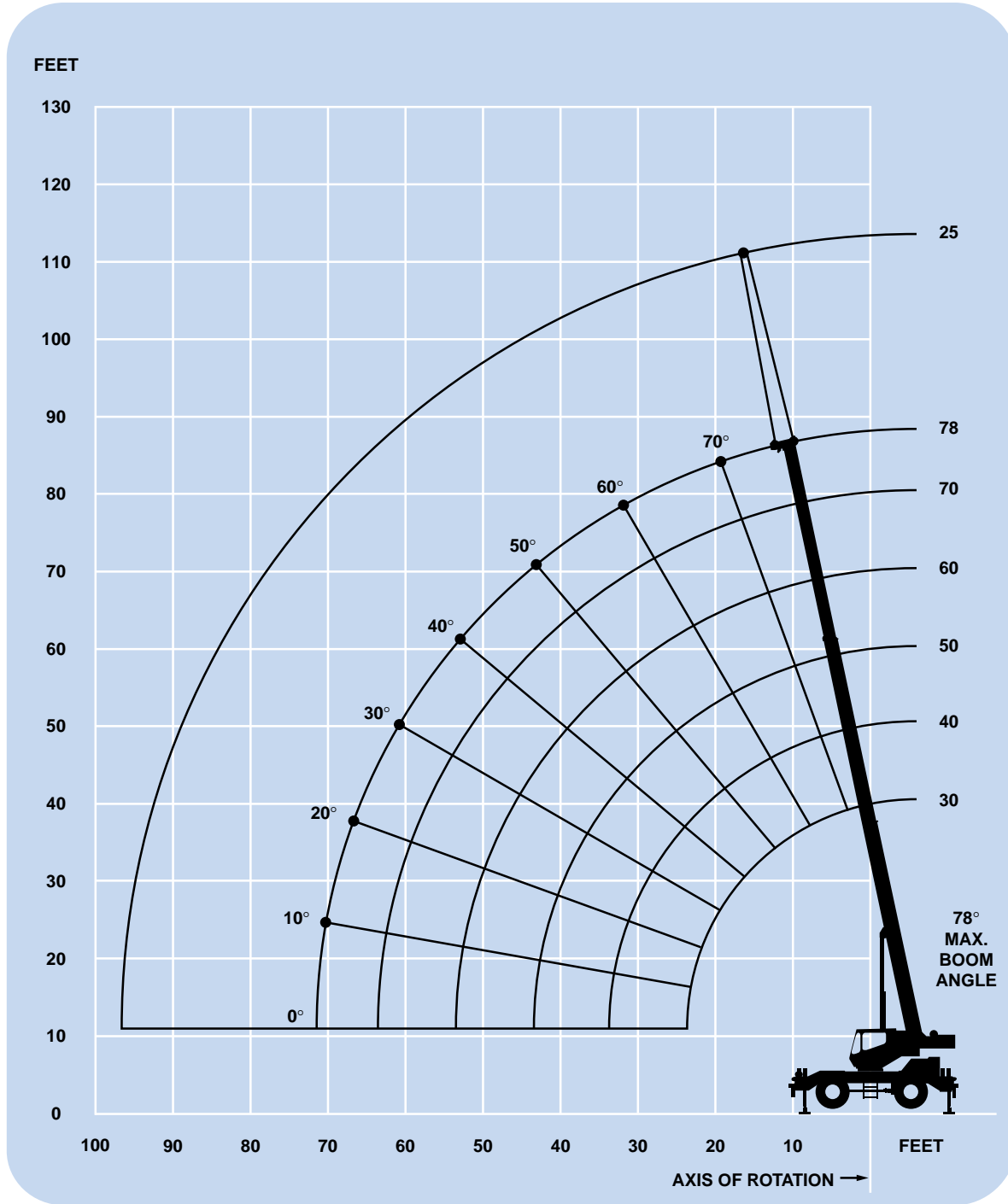

DIMENSIONS ARE FOR LARGEST GROVE FURNISHED HOOK BLOCK AND HEADACHE BALL, WITH ANTI-TWO BLOCK ACTIVATED.



Superstructure specifications

Boom

30 ft. - 78 ft. (9.2 m - 23.8 m) three-section full power boom. Maximum tip height: 84 ft. 9 in. (25.8 m).

Fixed Swingaway Extension

25 ft. (7.6 m) lattice swingaway extension. Non-offsettable. Stows alongside base boom section. Maximum tip height: 108 ft. 11 in. (33.2 m).

Boom Nose

Three steel sheaves mounted on heavy duty permalubed tapered roller bearings with removable pin-type rope guards. Quick reeve type boom nose. *Optional removable auxiliary boom nose with removable pin type rope guard.

Boom Elevation

One double acting hydraulic cylinder with integral holding valve provides elevation from -3° to +78°.

Load Moment & Anti-Two Block System

Standard load moment and anti two block system with audio-visual warning and control lever lockout. These systems provide electronic display of boom angle, length, radius, tip height, relative load moment, maximum permissible load, load indication and warning of impending two-block condition.

Cab

Full vision, all galvanealed steel fabricated with acoustical lining and tinted safety glass throughout. Deluxe reclining seat incorporates adjustable armrest with hydraulic single-axis controllers. Dash panel incorporates gauges for all engine functions. Other standard features include: cab circulating air fan, sliding side and rear windows, electric windshield wash/wipe, manual skylight wiper, swing horn, fire extinguisher, seat belt, and tachometer.

Swing

Planetary swing with foot applied multi-disc brake. Spring applied, hydraulically released swing brake. One position, plunger type mechanical house lock, and a 360° positive swing lock, both operated from cab. Maximum speed: 3.0 RPM.

Counterweight

5,700 lbs. (2586 kg) integral with superstructure. 773 lbs. (351 kg) slab in place of auxiliary hoist.

Hydraulic System

Two main gear pumps with a combined capacity of 72.0 GPM (272.5 LPM). Maximum operating pressure: 3500 PSI (241 bar).

Two individual pressure compensated valve banks.

Return line type filter with full flow by-pass protection and service indicator. Replaceable cartridge with micron filtration rating of 5/12/16.

82 gallon (310 L) reservoir.

Remote-mounted oil cooler with thermostatically controlled electric motor driven fan.

System pressure test ports with quick release type fittings for each circuit.

HOIST SPECIFICATIONS

Main and Auxiliary Hoist

Planetary reduction with automatic spring applied multi-disc brake. Grooved drum. Electronic hoist drum rotation indicator and hoist drum cable followers.

| | |
|--------------------------------|--------------------------|
| Maximum Single Line Pull: | 12,148 lbs. (5510 kg) |
| Maximum Single Line Speed: | 287 FPM (87 m/min) |
| Maximum Permissible Line Pull: | 9,080 lbs. (4119 kg) |
| Rope Diameter: | 5/8 in. (16 mm) |
| Rope Length: | 370 ft. (113 m) |
| Maximum Rope Stowage: | 370 ft. (113 m) |

*Denotes optional equipment



Carrier specifications

Chassis

Box section frame fabricated from high-strength, low alloy steel. Integral outrigger housings and front/rear towing and tie down lugs.

Outrigger System

Four hydraulic telescoping single-stage double box beam outriggers with inverted jacks and integral holding valves. Three position setting. All steel fabricated quick release type square outrigger floats, 16.5 in. (419 mm) square.
Maximum outrigger pad load: 38,600 lbs. (17 509 kg)

Outrigger Controls

Controls and crane level indicator located in cab.

Engine

Cummins 4BTA3.9 diesel, aftercooled, turbocharged, 130 bhp (96.7 kW) (Gross) @ 2,500 RPM.
Maximum torque: 360 ft. lbs. (488 Nm) @ 1,500 RPM.

Fuel Tank Capacity

40 gallons (151 L)

Transmission

Full powershift with 6 forward and 6 reverse speeds.
Front axle disconnect for 4 x 2 travel.

Electrical System

12 V - maintenance free battery.

Drive

4 x 4

Steering

Full independent power steering.
Front: Full hydraulic steering wheel controlled.
Rear: Full hydraulic hand lever controlled.
Provides 4 main steering modes: front only, rear only, crab and coordinated. Rear steer indicating gauge.

Axles

Front: Drive/steer with differential and planetary reduction hubs rigid mounted to frame.
Rear: Drive/steer with differential and planetary reduction hubs pivot mounted to frame.

Oscillation Lockouts

Automatic full hydraulic lockouts on rear axle permit oscillation only with boom centered over the front.

Brakes

Full hydraulic split circuit brakes operating on all wheels. Spring-applied, hydraulically released transmission-mounted parking brake.

Tires

17.5 x 25-20PR earthmover type, tubeless.

Lights

Full lighting package including turn indicators, head, tail, brake and hazard warning lights.

Maximum Speed

22 mph (35 kph)

Maximum Gradeability

Infinite (Theoretical based on 17.5 x 25 tires, 78 ft. [23.8 m] boom and 25 ft. [7.6 m] swingaway).

Miscellaneous Standard Equipment

Full width galvanealed steel fenders, dual rear view mirrors, hookblock tiedown, electronic back-up alarm, light package, front stowage well, cold start aid (less canister), cab mounted worklight, engine distress A/V warning.

*Optional Equipment

- * Auxiliary hoist (Dealer installed)
- * Hookblock
- * Headache ball
- * Auxiliary boom nose (Dealer installed)

**Denotes optional equipment*





30 - 78 ft.
(9.2 - 23.8 m)



5,700 lbs.
(2586 kg)



100%



360°



Pounds

25 ft. Ext
& 78 ft.
Boom

| Feet | 30 | 40 | 50 | 60 | 70 | 78 | 103 |
|--|------------------|------------------|------------------|------------------|------------------|-----------------|------------------|
| 10 | 44,000 (62) | 42,850 (70) | 39,150 (74.5) | *31,450 (78) | | | |
| 12 | 39,300 (57.5) | 38,400 (67) | 36,100 (72) | 31,450 (76) | | | |
| 15 | 31,300 (50) | 31,300 (62) | 31,700 (68.5) | 27,850 (73) | 25,300 (76) | *16,200 (78) | |
| 20 | 22,450 (34) | 23,050 (53) | 23,450 (62) | 23,250 (67.5) | 21,000 (71.5) | 16,200 (74) | *12,500 (78) |
| 25 | | 17,300 (42.5) | 17,450 (55) | 17,900 (62) | 17,500 (67) | 13,300 (70) | 11,400 (75.5) |
| 30 | | 13,450 (29) | 13,700 (47) | 14,000 (56.5) | 13,800 (62.5) | 11,200 (66) | 10,200 (72.5) |
| 35 | | | 10,500 (38) | 10,750 (50) | 10,900 (57.5) | 9,600 (61.5) | 9,500 (69.5) |
| 40 | | | 8,590 (26) | 8,840 (43) | 9,000 (52) | 8,330 (57.5) | 8,250 (66.5) |
| 45 | | | | 7,140 (35) | 7,290 (46.5) | 7,310 (52.5) | 7,170 (63.5) |
| 50 | | | | 5,740 (24) | 5,910 (40) | 6,050 (47.5) | 6,260 (60) |
| 55 | | | | | 4,840 (32.5) | 4,990 (42) | 5,500 (57) |
| 60 | | | | | 3,970 (22.5) | 4,140 (35.5) | 4,660 (53) |
| 65 | | | | | | 3,440 (27.5) | 3,930 (49.5) |
| 70 | | | | | | 2,850 (16) | 3,320 (45.5) |
| 75 | | | | | | | 2,800 (41) |
| 80 | | | | | | | 2,360 (36.5) |
| 85 | | | | | | | 1,980 (31) |
| 90 | | | | | | | 1,640 (24) |
| 95 | | | | | | | 1,340 (14) |
| Minimum boom angle (deg.) for indicated length | | | | | | | 0 |
| Maximum boom length (ft.) at 0 deg. boom angle (no load) | | | | | | | 103 |

NOTE: () Boom angles are in degrees.
* This capacity is based upon maximum boom angle.

| Boom Angle | 30 | 40 | 50 | 60 | 70 | 78 |
|------------|------------------|-----------------|-----------------|-----------------|-----------------|-----------------|
| 0° | 10,950 (23.8) | 7,360 (33.8) | 5,190 (43.8) | 3,740 (53.8) | 2,710 (63.8) | 2,060 (71.8) |

NOTE: () Reference radii in feet.

A6-829-015872

THIS CHART IS ONLY A GUIDE AND SHOULD NOT BE USED TO OPERATE THE CRANE. The individual crane's load chart, operating instructions and other instructional plates must be read and understood prior to operating the crane.



30 - 78 ft.
(9.2 - 23.8 m)



5,700 lbs.
(2586 kg)



50%
13' (4.0 m) Spread



360°



Pounds

25 ft. Ext
& 78 ft.
Boom

| Feet | 30 | 40 | 50 | 60 | 70 | 78 | 103 |
|--|------------------|------------------|------------------|------------------|------------------|-----------------|------------------|
| 10 | 38,800 (62) | 39,300 (70) | 39,150 (74.5) | *31,450 (78) | | | |
| 12 | 33,750 (57.5) | 34,200 (67) | 34,500 (72) | 31,450 (76) | | | |
| 15 | 27,950 (50) | 27,650 (62) | 26,400 (68.5) | 25,200 (73) | 24,100 (76) | *16,200 (78) | |
| 20 | 17,200 (34) | 17,300 (53) | 17,200 (62) | 16,700 (67.5) | 16,150 (71.5) | 15,750 (74) | *12,500 (78) |
| 25 | | 11,450 (42.5) | 11,600 (55) | 11,800 (62) | 11,750 (67) | 11,500 (70) | 11,350 (75.5) |
| 30 | | 8,130 (29) | 8,280 (47) | 8,460 (56.5) | 8,660 (62.5) | 8,780 (66) | 8,800 (72.5) |
| 35 | | | 6,100 (38) | 6,270 (50) | 6,450 (57.5) | 6,610 (61.5) | 6,990 (69.5) |
| 40 | | | 4,550 (26) | 4,730 (43) | 4,900 (52) | 5,060 (57.5) | 5,610 (66.5) |
| 45 | | | | 3,590 (35) | 3,760 (46.5) | 3,910 (52.5) | 4,430 (63.5) |
| 50 | | | | 2,690 (24) | 2,880 (40) | 3,020 (47.5) | 3,520 (60) |
| 55 | | | | | 2,180 (32.5) | 2,320 (42) | 2,800 (57) |
| 60 | | | | | 1,590 (22.5) | 1,750 (35.5) | 2,210 (53) |
| 65 | | | | | | 1,260 (27.5) | 1,720 (49.5) |
| 70 | | | | | | | 1,310 (45.5) |
| 0.1A (lbs.) | 465 | 440 | 420 | 410 | 400 | 395 | 380 |
| Minimum boom angle (deg.) for indicated length | | | | | | 21 | 43 |
| Maximum boom length (ft.) at 0 deg. boom angle (no load) | | | | | | | 70 |

NOTE: () Boom angles are in degrees.
* This capacity is based upon maximum boom angle.

| Boom Angle | 30 | 40 | 50 | 60 | 70 |
|------------|------------------|-----------------|-----------------|-----------------|-----------------|
| 0° | 10,950 (23.8) | 6,370 (33.8) | 3,640 (43.8) | 2,140 (53.8) | 1,210 (63.8) |

NOTE: () Reference radii in feet.

A6-829-015873

THIS CHART IS ONLY A GUIDE AND SHOULD NOT BE USED TO OPERATE THE CRANE. The individual crane's load chart, operating instructions and other instructional plates must be read and understood prior to operating the crane.

RT522B

7





30 - 78 ft.
(9.2 - 23.8 m)



5,700 lbs.
(2586 kg)



0%
7' 7" (2.3 m) Spread



360°



Pounds

| Feet | 30 | 40 | 50 | 60 | 70 | 78 |
|--|------------------|-----------------|------------------|-----------------|-----------------|-----------------|
| 10 | 24,650 (62) | 23,350 (70) | 22,050 (74.5) | *18,100 (78) | | |
| 12 | 18,850 (57.5) | 18,250 (67) | 17,450 (72) | 16,650 (76) | | |
| 15 | 13,400 (50) | 13,300 (62) | 12,950 (68.5) | 12,450 (73) | 12,000 (76) | *11,450 (78) |
| 20 | 8,320 (34) | 8,390 (53) | 8,500 (62) | 8,340 (67.5) | 8,120 (71.5) | 7,940 (74) |
| 25 | | 5,410 (42.5) | 5,550 (55) | 5,730 (62) | 5,740 (67) | 5,640 (70) |
| 30 | | 3,560 (29) | 3,700 (47) | 3,860 (56.5) | 4,040 (62.5) | 4,090 (66) |
| 35 | | | 2,440 (38) | 2,600 (50) | 2,770 (57.5) | 2,910 (61.5) |
| 40 | | | 1,520 (26) | 1,680 (43) | 1,850 (52) | 1,990 (57.5) |
| 45 | | | | | 1,150 (46.5) | 1,280 (52.5) |
| 0.1A (lbs.) | 465 | 440 | 420 | 410 | 400 | 395 |
| Minimum boom angle (deg.) for indicated length | | | 13 | 38 | 44 | 48 |

Maximum boom length (ft.) at 0 deg. boom angle (no load) 40

NOTE: () Boom angles are in degrees.
* This capacity is based upon maximum boom angle.

| Boom Angle | 30 | 40 |
|------------|-----------------|-----------------|
| 0° | 5,850 (23.8) | 2,540 (33.8) |

NOTE: () Reference radii in feet.

A6-829-015874

THIS CHART IS ONLY A GUIDE AND SHOULD NOT BE USED TO OPERATE THE CRANE. The individual crane's load chart, operating instructions and other instructional plates must be read and understood prior to operating the crane.





30 - 78 ft.
(9.2 - 23.8 m)



5,700 lbs.
(2586 kg)



Stationary



360°

17.5 x 25 (20 Ply) Tires



Pounds

| Feet | 30 | 40 | 50 | 60 |
|--|------------------|-----------------|------------------|-----------------|
| 10 | 18,150 (62) | 18,150 (70) | 18,150 (74.5) | |
| 12 | 14,950 (57.5) | 14,950 (67) | 14,950 (72) | 14,950 (76) |
| 15 | 11,250 (50) | 11,250 (62) | 11,250 (68.5) | 11,250 (73) |
| 20 | 6,530 (34) | 6,530 (53) | 6,530 (62) | 6,530 (67.5) |
| 25 | | 4,100 (42.5) | 4,100 (55) | 4,100 (62) |
| 30 | | 2,900 (29) | 2,900 (47) | 2,900 (56.5) |
| 35 | | | 1,840 (38) | 1,840 (50) |
| 40 | | | 1,040 (26) | 1,040 (43) |
| Minimum boom angle (deg.) for indicated length (no load) | | | 5 | 29.5 |
| Maximum boom length (ft.) at 0 deg. boom angle (no load) | | | 40 | |
| NOTE: () Boom angles are in degrees | | | | |
| Boom Angle | 30 | 40 | | |
| 0° | 4,120 (23.8) | 1,840 (33.8) | | |

NOTE () Reference radii in feet.

A6-829-015875

THIS CHART IS ONLY A GUIDE AND SHOULD NOT BE USED TO OPERATE THE CRANE. The individual crane's load chart, operating instructions and other instructional plates must be read and understood prior to operating the crane.

RT522B

9



30 - 78 ft.
(9.2 - 23.8 m)



5,700 lbs.
(2586 kg)



Stationary



Defined Arc
Over Front
±6°

17.5 x 25 (20 Ply) Tires



Pounds

| Feet | 30 | 40 | 50 | 60 |
|--|------------------|-----------------|------------------|------------------|
| 10 | 21,650 (62) | 21,650 (70) | 21,650 (74.5) | |
| 12 | 18,850 (57.5) | 18,850 (67) | 18,850 (72) | 18,850 (76) |
| 15 | 15,650 (50) | 15,650 (62) | 15,650 (68.5) | 15,650 (73) |
| 20 | 11,800 (34) | 11,800 (53) | 11,800 (62) | 11,800 (67.5) |
| 25 | | 8,030 (42.5) | 8,030 (55) | 8,030 (62) |
| 30 | | 5,910 (29) | 5,910 (47) | 5,910 (56.5) |
| 35 | | | 4,490 (38) | 4,490 (50) |
| 40 | | | 3,470 (26) | 3,470 (43) |
| 45 | | | | 2,710 (35) |
| 50 | | | | 2,110 (24) |
| Minimum boom angle (deg.) for indicated length (no load) | | | | 0 |
| Maximum boom length (ft.) at 0 deg. boom angle (no load) | | | | 60 |
| NOTE: () Boom angles are in degrees | | | | |
| Boom Angle | 30 | 40 | 50 | 60 |
| 0° | 8,720 (23.8) | 4,790 (33.8) | 2,880 (43.8) | 1,750 (53.8) |

NOTE () Reference radii in feet.

A6-829-015876

THIS CHART IS ONLY A GUIDE AND SHOULD NOT BE USED TO OPERATE THE CRANE. The individual crane's load chart, operating instructions and other instructional plates must be read and understood prior to operating the crane.





30 - 78 ft.
(9.2 - 23.8 m)



5,700 lbs.
(2586 kg)



Pick & Carry
Up to 2.5 MPH



Boom Centered
Over Front

17.5 x 25 (20 Ply) Tires



Pounds

| Feet | 30 | 40 | 50 | 60 |
|--|------------------|-----------------|------------------|------------------|
| 10 | 21,000 (62) | 21,000 (70) | 21,000 (74.5) | |
| 12 | 18,000 (57.5) | 18,000 (67) | 18,000 (72) | 18,000 (76) |
| 15 | 14,600 (50) | 14,600 (62) | 14,600 (68.5) | 14,600 (73) |
| 20 | 10,700 (34) | 10,700 (53) | 10,700 (62) | 10,700 (67.5) |
| 25 | | 8,030 (42.5) | 8,030 (55) | 8,030 (62) |
| 30 | | 4,940 (29) | 4,940 (47) | 4,940 (56.5) |
| 35 | | | 3,880 (38) | 3,880 (50) |
| 40 | | | 3,060 (26) | 3,060 (43) |
| 45 | | | | 2,400 (35) |
| 50 | | | | 1,870 (24) |
| Minimum boom angle (deg.) for indicated length (no load) | | | | 0 |
| Maximum boom length (ft.) at 0 deg. boom angle (no load) | | | | 60 |

NOTE: () Boom angles are in degrees

| Boom Angle | 30 | 40 | 50 | 60 |
|------------|-----------------|-----------------|-----------------|-----------------|
| 0° | 8,700 (23.8) | 4,120 (33.8) | 2,560 (43.8) | 1,520 (53.8) |

NOTE: () Reference radii in feet.

A6-829-015877

THIS CHART IS ONLY A GUIDE AND SHOULD NOT BE USED TO OPERATE THE CRANE. The individual crane's load chart, operating instructions and other instructional plates must be read and understood prior to operating the crane.





































Rated Lifting Capacities

IMPORTANT NOTES:

WARNING: THIS CHART IS ONLY A GUIDE. The notes below are for illustration only and should not be relied upon to operate the crane. The individual crane's load chart, operating instructions and other instruction plates must be read and understood prior to operating the crane.

1. All rated loads meet ANSI/ASME B30.5, Mobile and Locomotive Cranes. Testing and development were performed to SAEJ1063, Cantilevered Boom Crane Structures - Method of Test and SAEJ765 Crane Stability Test Code.
2. Rated loads include the weight of hookblock, slings and auxiliary lifting devices and their weights shall be subtracted from the listed rating to obtain the net load to be lifted. When more than the minimum required hoist reeving is used, the additional rope weight shall be considered part of the load to be handled.
3. Defined Arc $\pm 6^\circ$ on either side of longitudinal centerline of machine.
4. Capacities appearing above the bold line are based on structural strength. Tipping should not be relied upon as a capacity indication.
5. The machine shall be leveled on a firm supporting surface. Depending on the nature of the supporting surface, it may be necessary to have structural supports under the outrigger floats or tires to spread the load to a larger bearing surface.
6. When either boom length or radius or both are between values listed, the smallest load shown at either the next larger radius or next longer or shorter boom length shall be used.
7. Tires shall be inflated to the recommended pressure before lifting on rubber.
8. For outrigger operation, outriggers shall be properly extended with tires raised free of crane weight before operating the boom or lifting loads.

Symbols Glossary

| | | | |
|---|--------------------|---|------------------|
|  | Frame |  | Steering |
|  | Outriggers |  | Transmission |
|  | Outrigger Controls |  | Axles |
|  | Engine |  | Brakes |
|  | Fuel Tank Capacity |  | Tires |
|  | Electrical System |  | Suspension |
|  | Drive |  | Rotation |
|  | Lights |  | Boom Elevation |
|  | Cab |  | Swing |
|  | Boom |  | Counterweight |
|  | Fixed Swingaway |  | Oil |
|  | Tele-Swingaway |  | Hydraulic System |
|  | Jib |  | Hoist |
|  | Boom Nose |  | Radius |
|  | Boom Extension |  | Boom Length |
|  | Speed |  | Hookblock |
|  | Grade |  | Gear |
|  | Lattice Extension |  | Luffing Jib |

RT522B

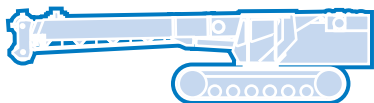
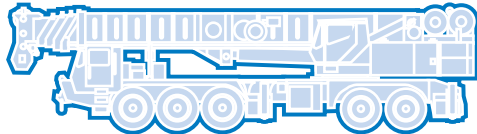
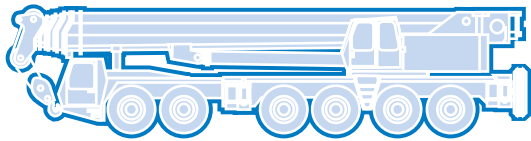
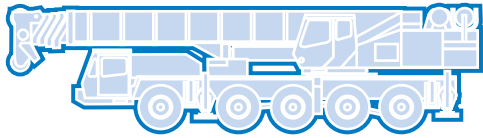

Grove Worldwide – World Headquarters

Grove North America
 1565 Buchanan Trail East
 P.O. Box 21
 Shady Grove, Pennsylvania 17256, U.S.A.
 Tel: [Int + 1] (717) 597-8121
 Fax: [Int + 1] (717) 597-4062
 Western Hemisphere, Asia/Pacific

Grove Europe Limited*

Sunderland SR4 6TT, England
 Tel: [Int + 44] 191 565-6281
 Fax: [Int + 44] 191 564-0442
 Europe, Africa, Middle East

Grove Europe Limited*

P.O. Box No. 268
 4A Kimber Road
 Abingdon, Oxfordshire, OX141SG
 Tel: [Int + 44] 1235 55-3184
 Fax: [Int + 44] 1235 55-3218
*Grove Europe Limited, Registered in England,
 Number 1845128, Registered office, Crown Works,
 Pallion, Sunderland, Tyne & Wear, England SR4 6TT

Deutsche Grove GmbH

Sales and Service
 Helmholtzstrasse 12, Postfach 5026
 D-40750 Langenfeld, Germany
 Tel: [Int + 49] (2173) 8909-0
 Fax: [Int + 49] (2173) 8909-30

Wilhelmshaven Works

Industriegelände West, Postfach 1853
 D-26358 Wilhelmshaven, Germany
 Tel: [Int + 49] (4421) 294-0
 Fax: [Int + 49] (4421) 294-301

Grove France S.A.

16, chaussée Jules-César, 95520 OSNY
 B.P. 203, 95523 CERGY PONTOISE CEDEX
 France
 Tel: [Int + 33] (1) 30313150
 Int: [Int + 33] (1) 30386085

Grove Asia/Pacific - Regional Office

171 Chin Swee Road
 #06-01 San Centre
 Singapore 0316
 Tel: [Int + 65] 536-6112
 Fax: [Int + 65] 536-6119
 Asia/Pacific, Near East

Grove China - Representative Office

Beijing Suite 6074
 No. 33 East Chang An Avenue
 Beijing, 100004, China
 Tel: [Int + 86] (10) 513-7766
 Fax: [Int + 86] (10) 513-7307

Grove Product Support

Western Hemisphere, Asia/Pacific
 1086 Wayne Avenue
 Chambersburg, Pennsylvania USA
 Tel: [Int + 1] (717) 263-5100
 Fax: [Int + 1] (717) 267-0404

Europe, Africa, Middle East
 Sunderland SR4 6TT, England
 Tel: [Int + 44] 191 565-6281
 Parts Fax: [Int + 44] 191 510-9242
 Service Fax: [Int + 44] 191 510-9560

<http://www.grovetworldwide.com>

Bigge Crane and Rigging Co.

10700 Bigge Avenue
 San Leandro, CA 94577
 Phone: (888) 337-BIGGE or (510) 638-8100
 Fax: (510) 639-4053
 Email: info@bigge.com
 Web site: www.bigge.com

Constant improvement and engineering progress make it necessary that we reserve the right to make specification, equipment, and price changes without notice. Illustrations shown may include optional equipment and accessories and may not include all standard equipment.

Distributed By:

Form No.: SBRT522B Part No.: 3-1150 298-10M Printed in U.S.A.

