

5426 (#5379 & #6253 consolidated) - 1104 - F8

Technical Data

Specifications & Capacities

HTC
8640

Telescopic Boom Truck Crane
40 ton (36.29 metric ton)

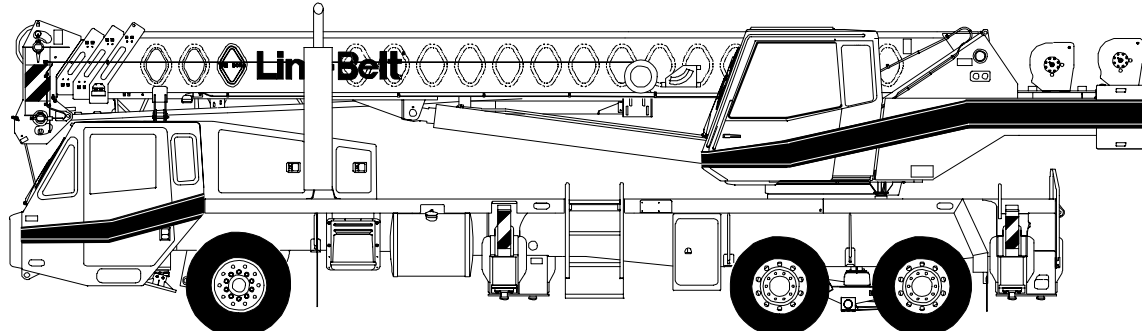

CAUTION: This material is supplied for reference use only. Operator must refer to in-cab Crane Rating Manual and Operator's Manual to determine allowable crane lifting capacities and assembly and operating procedures.





5426 (#5379 & #6253 consolidated)–1104–F8

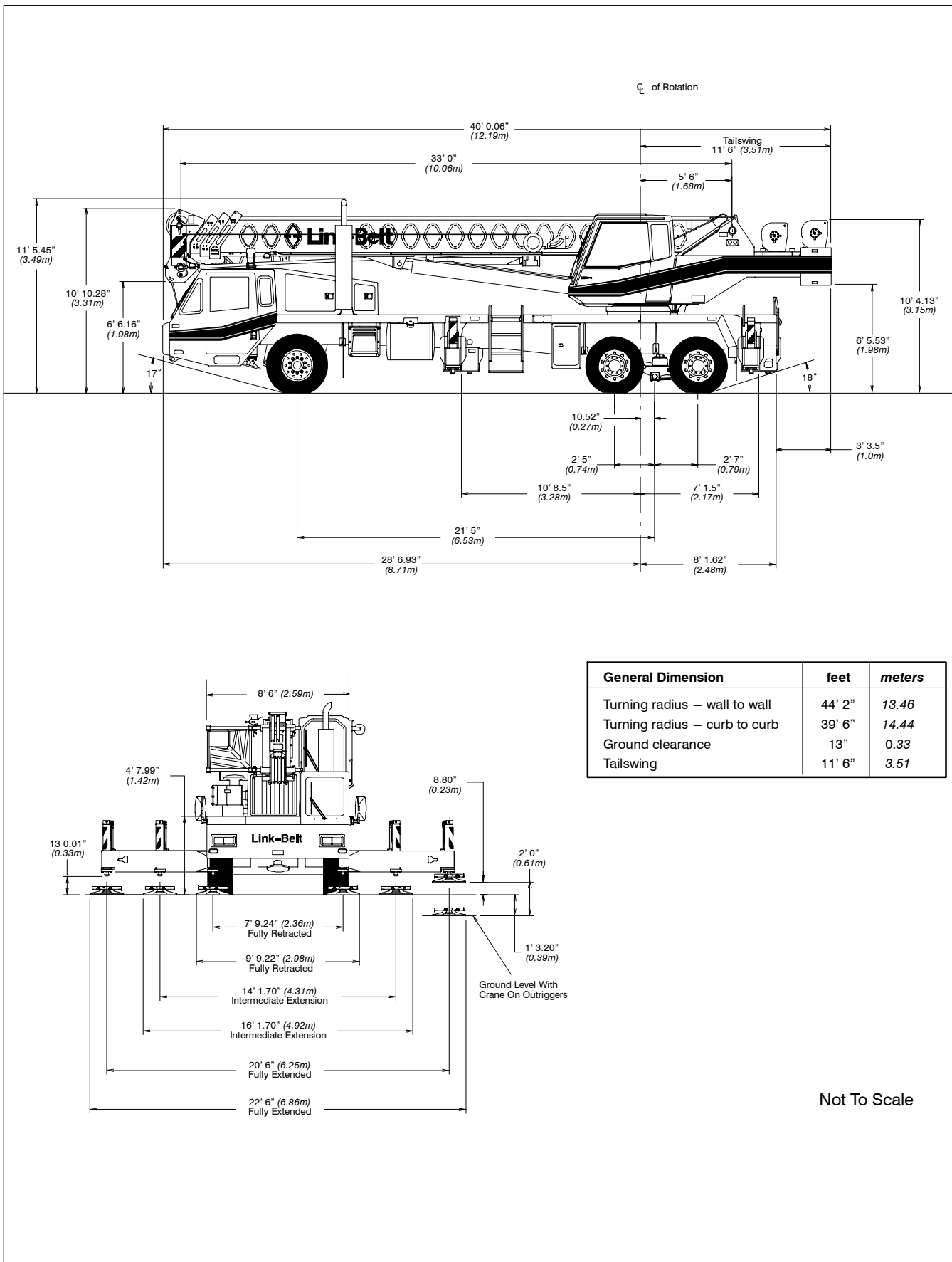

Upper Structure

■ Boom

Patented Design

- Boom side plates have diamond shaped impressions for superior strength to weight ratio and 100,000 psi (689.5MPa) steel angle chords for lateral stiffness
- Boom telescope sections are supported by top, bottom, and adjustable side wear shoes to prevent metal to metal contact

Boom

- 33–105 ft (10.06–32.00m) four–section full power boom.
- Two mode boom extension
- The basic mode is the full power, synchronized mode of telescoping all sections proportionally to 105 ft (32.00m)
- The exclusive “A–max” mode (or mode ‘A’) extends only the inner mid section to 57 ft (17.37m) offering increased capacities for in–close, maximum capacity picks
- Mechanical boom angle indicator

Boom Head

- Four 16.5 in (0.42m) root diameter nylon sheaves to handle up to eight parts of wire rope.
- Easily removable wire rope guards
- Rope dead end lugs provided on each side of boom head.
- Boom head designed for quick reeve of hook block

Boom Elevation

- One Link–Belt designed hydraulic cylinder with holding valve and bushing in each end
- Hand control for controlling boom elevation from –3° to +78°

Optional Auxiliary Lifting Sheave

- Single 16.5 in (0.42m) root diameter nylon sheave with removable wire rope guard, mounted to boom
- Use with one or two parts of line off the optional front winch
- Does not affect erection of fly or use of main head sheaves for multiple reeving

Optional

- 25–ton (22.7mt) quick reeve hook block
- 40–ton (36.3mt) quick reeve hook block
- 8.5–ton (7.7mt) hook ball
- Boom floodlight

■ Fly

Optional

- 28.5 ft (8.69m) offsettable stowable one–piece lattice type with lugs to allow for addition of second section. Can be offset 2°, 20°, or 40°.
- 28.5–51 ft (8.69–15.54m) offsettable stowable 2–piece lattice type. Can be offset 2°, 20°, or 40°.

■ Cab and Controls

Environmental Ultra–Cab™

- Laminated fibrous composite material; isolated from sound with acoustical fabric insulation
- Windows are tinted and tempered safety glass
- Sliding rear and right side windows and swing–up roof window for maximum visibility and ventilation
- Slide–by–door opens to 3 ft (0.91m) width
- Six–way adjustable seat for maximum operator comfort
- Hand–held outrigger controls and sight level bubble located in cab
- Diesel cab heater
- Pull–out Cabwalk™
 - Circulating fan
 - Audible swing alarm
 - Fire extinguisher
 - 12–volt accessory outlet
 - Electric windshield wiper
 - Windshield washer
 - Top hatch window wiper
 - Warning horn
 - Cup holder
 - Sun screen
 - Hand throttle
 - Mirrors
 - Dome light

Optional

- Amber strobe light
- Amber rotating beacon
- Hydraulic heater
- Air conditioning

Controls

Hydraulic controls (joy–stick type) for:

- Swing
- Main winch
- Optional auxiliary winch
- Boom hoist

Foot controls for:

- Boom telescope
- Swing brake
- Engine throttle

Optional

- Auxiliary winch
- Single axis controls

Cab Instrumentation

Cornerpost–mounted gauges for:

- Hydraulic oil temperature
- Audio/Visual warning system
- Tachometer
- Voltmeter
- Water temperature
- Oil pressure
- Fuel

■ Rated Capacity Limiter

- **Microguard 434** Graphic audio–visual warning system built into dash with anti–two block and function limiters

Operating data available includes:

- Machine configuration
- Boom length
- Head height
- Allowed load
- % of allowed load
- Boom angle
- Radius of load
- Actual load

Presettable alarms include:

- Maximum and minimum boom angles
- Maximum tip height
- Maximum boom length
- Swing left/right positions
- Operator defined area alarm is standard
- Anti–two block weight designed for quick reeve of hook block

Optional

- **Internal RCL light bar:** Visually informs operator when crane is approaching maximum load capacity with a series of three lights; green, yellow, and red
- **External RCL light bar:** Visually informs ground crew when crane is approaching maximum load capacity kickouts and presettable alarms with a series of three lights; green, yellow, and red

■ Swing

- Bi–directional hydraulic swing motor mounted to a planetary reducer for 360° continuous smooth swing at 2.8 rpm
- **Swing park brake** – 360°, electric over hydraulic (spring applied, hydraulic released) multi–disc brake mounted on the speed reducer. Operated by toggle switch in overhead control console.
- **Swing brake** – 360°, foot operated, hydraulic applied disc brake mounted on the speed reducer
- **Swing lock** – Standard; two position travel lock operated from the operator’s cab
- **Counterweight**
 - Standard – Bolted to upper structure frame. 4,700 lb (2 132kg) one piece design
 - Optional – 2,000 lb (907kg) additional counterweight can be inserted into pockets in main counterweight

Optional

- 360° swing lock. Meets New York City requirements



Hydraulic System

Main Pump

- One gear pump with a total of four sections
- Combined pump capacity of 131 gpm (488Lpm)
- Powered by carrier engine through power take-off (PTO)
- Spline type pump disconnect, mechanically activated pump disconnect engaged/disengaged from carrier cab
- Maximum system operating pressure is 3,350 psi (23 098kPa)
- O-ring face seals technology used throughout with hydraulic oil cooler standard

Steering / Fifth Outrigger Pump

- Single gear type pump, 6 gpm (23Lpm) Powered by carrier engine through front gear housing

- Max. pump operating pressure is 2,000 psi (13 790kPa). Reservoir – 131 gal (507.2L) capacity. One diffuser for deaeration

Filtration

- One 10-micron filter located inside hydraulic reservoir
- Accessible for easy replacement

Control valves

- Five separate pilot operated control valves allow simultaneous operation of all crane functions

Load Hoist System

Standard

- 2M main winch with grooved lagging
- Two-speed motor and automatic brake
- Power up/down mode of operation
- Bi-directional piston-type hydraulic motor driven through planetary reduction unit for positive control under all load conditions

- Asynchronous parallel double crossover grooved drums minimize rope harmonic motion
- Pressure compensated winch circuit provides balanced oil flow to both winches for smooth, simultaneous operation
- Rotation resistant wire rope
- Drum rotation indicators

Line Pulls and Speeds

- Maximum available line pull 13,010 lb (5 901kg) and maximum line speed of 480 fpm (146m/min) on 10.63 in (0.27m) root diameter grooved drum.

Optional

- 2M auxiliary winch with two-speed motor, automatic brake, and winch function lock-out. Power up/down modes
- Hoist drum cable followers
- Third wrap indicators

Carrier

Type

- 8 ft 6 in (2.59m) wide, 257 in (6.53m) wheelbase. 6 x 4 drive – standard.

Frame

- 100,000 psi (689.5MPa) steel, double walled construction with integral 100,000 psi steel outrigger boxes

Optional

- Carrier mounted storage boxes
- Pintle hook
- Electric and air connections for trailers

Axles

Front

- Single, 83.22 in (2.11m) track

Rear

- Tandem, 76.17 in (1.93m) track. 5.57 to 1.0 ratio with interaxle differential with lockout (6.17:1 ratio with automatic transmission)

Suspension

Front axle

- Leaf spring suspension

Rear axle

- Air-ride, bogie beam type, suspension

Wheels

Standard

- Hub piloted steel disc

Optional

- Hub piloted aluminum disc
- Spare tire and wheel assemblies

Tires

Standard Front

- 425/65R22.5 (Load range "L") single tubeless radials

Standard Rear

- 275/80R22.5 (Load range "H") dual tubeless radials

Optional Rear

- 11R22.5 (Load range "H") dual tubeless radials

Brakes

Service

- Full air brakes on all wheel ends with automatic slack adjusters. Dual circuit with modulated emergency brakes.
 - Front – 16.5 x 6 S-Cam brakes
 - Rear – 16.5 x 7 S-Cam brakes

Parking/Emergency

- One spring set, air released chamber per rear axle end
- Parking brake applied with valve mounted on carrier dash
- Emergency brakes apply automatically when air drops below 40 psi (275.8kPa) in both systems

Steering

- Sheppard rack and pinion design

Optional

- Remote drive and steer

Transmission

Standard

- Eaton RTX-11609B; 9 speeds forward, 2 reverse

Optional

- Automatic Allison MD 3066, 65:1 high, 3.49:1 low

Auxiliary

- Eaton 2A-92, two speed – High: 1.0:1 Low: 2.3:1 (with automatic transmission only)

Electrical

- Two 12-volt batteries provide 12-volt starting. 160-amp alternator.
- 1,400 cold cranking amps available
- 12-volt operating system

Lights

- Four dual beam sealed headlights
- Front, side, and rear directional signals
- Stop, tail and license plate lights
- Rear and side clearance lights
- Hazard warning lights

Outriggers

- Three position operation capability
- Four hydraulic, telescoping beam and jack outriggers
- Vertical jack cylinders equipped with integral holding valve
- Beams extend to 20' 6" (6.25m) centerline-to-centerline and retract to within 8' 6" (2.59m) overall width
- Equipped with stowable, lightweight 24" (0.61m) diameter aluminum floats
- Standard fifth outrigger, 16" (0.41m) self storing steel pad is operable from ground or operator's cab
- Hand-held controls and sight level bubble located on carrier deck

Confined Area Lifting Capacities (CALC™) System

- The crane is operational in one of the three outriggers positions and operational in confined areas in two positions (intermediate and full retraction). The three outrigger positions are:
 - Full extension – 20 ft 6 in (6.25m)
 - Intermediate position – 14 ft 1.70 in (4.31m)
 - Full retraction – 7 ft 9.24 in (2.36m)
- Capacities are available with the outrigger beams in the intermediate and full retraction positions
- When the outrigger position levers (located on the outrigger beams) are engaged, the operator can set the crane in the intermediate or full retraction outrigger position without having to leave the cab



Carrier Cab

- One–man cab of laminated fibrous composite material acoustical insulation with cloth covering

Equipped with:

- Air–ride, six–way adjustable operator's seat
- Four–way adjustable tilting and lockable steering wheel
- Door and windows locks
- Left–hand and right–hand rear view mirrors
- Sliding right–hand and rear tinted windows
- Roll up/down left–hand tinted window

- Desiccant–type air dryer
- Steps to upper, lower cab, and rear carrier
- 120–volt electric engine block heater
- Back–up warning alarm
- Tow hooks and shackles
- Aluminum fenders with ground control outriggers
- Electric windshield wiper and washer
- Travel lights
- Fire extinguisher
- 36,000 BTU heater
- Dome light
- Mud flaps
- Horn
- Ashtray
- Defroster
- Cruise control

Optional

- Rotating Beacon
- Air conditioning
- Amber Strobe Light

Cab instrumentation

- Illuminated instrument panel speedometer
- Tachometer
- Fuel gauge
- Oil pressure gauge
- Turn signal indicator
- Water temperature gauge
- Front and rear air pressure gauges
- Audio/visual warning system
- Automotive type ignition
- Hourmeter
- Fuses
- Odometer
- Voltmeter

Carrier Speeds *(Manual Transmission – Standard tires)*

Gear	High				Low					Hi Rev.	Lo Rev.	Low Rev. @700 rpm	Low @700 rpm	
	8	7	6	5	4	3	2	1	Low	Rev.	Rev.	Low Rev.	Low	
Ratio	0.73	1.00	1.38	1.95	2.79	3.83	5.28	7.47	12.57	3.43	13.14	13.14	12.57	
Speed	mph	58.92	43.01	31.17	22.06	15.42	11.23	8.15	5.76	3.42	12.54	3.12	1.04	1.09
	km/hr.	94.80	69.20	50.15	35.49	24.08	18.07	13.11	9.26	5.51	20.18	5.03	1.68	1.75

Engine

Engine – standard	Cummins ISC 350	Engine – optional	Cummins ISL 330 with Jake Brake
Cylinders – cycle	6 / 4	Cylinders – cycle	6 / 4
Bore	4.49 in (114mm)	Bore	4.49 in (114mm)
Stroke	5.32 in (135mm)	Stroke	5.69 in (145mm)
Displacement	504.5 cu. in. (8 268cm ³)	Displacement	540 cu. in. (8 849cm ³)
Maximum brake hp.	350 @ 2,000 rpm; 335 @ 2,200 rpm	Maximum brake hp.	345 @ 1,900 rpm; 330 @ 2,100 rpm
Peak torque	1,050 ft lb (1 560J) @ 1,300 rpm	Peak torque	1,150 ft lb (1 559.2 J) @ 1,300 – 1,400 rpm
Electric system	12–volt neg. ground/12 volt starting	Electric system	12–volt neg. ground / 12 volt starting
Fuel capacity	75 gal (284L)	Fuel capacity	75 gal (284L)
Alternator	12 volt, 160 amps	Alternator	12 volt, 160 amps
Crankcase capacity	20 qt (19L)	Crankcase capacity	29 qt (28L)



5426 (#5379 & #6253 consolidated) – 1104 – F8

■ Axle Loads

Base machine with standard 33 – 105 ft (10.06 – 32.00m) four – section boom, 2M main winch with 2 – speed hoisting and power up/down, 450 ft (137m), 5/8 in (19mm) wire rope, 8 x 4, 8.5 ft (2.59m) carrier with Cummins ISC 350 Engine, 75 gal (284L) fuel, aluminum fenders, and 4,700 lb (2 132kg) counterweight.	G.V.W. ¹		Upper Facing Front			
			Front Axle		Rear Axle	
		lb	kg	lb	kg	lb
	56,828	25 777	17,607	7 986	39,221	17 790
One – quarter tank of diesel fuel	–394	–179	–269	–122	–125	–57
Left side carrier aluminum storage box	57	26	14	6	43	20
Right side carrier aluminum storage box	57	26	14	6	43	20
Cummins ISL – 330 engine with engine brake	25	11	23	10	2	1
Six – speed automatic transmission and two – speed auxiliary transmission with engine brake	601	273	266	121	335	152
Tire and aluminum disc 425/65R22.5 fronts – 11R22.5 rears	–520	–236	–110	–50	–410	–186
Air conditioning – Carrier cab	124	56	135	61	–11	–5
Pintle hook w/air and electrical hook – ups	32	15	–9	–4	41	19
Driver in carrier cab	200	91	236	107	–36	–16
Cab heater assembly (hydraulic)	110	50	–8	–4	118	5
Air conditioning – Operator cab	315	143	–35	–16	350	159
Rear winch roller	77	35	–31	–14	108	49
Front winches with two speeds and 450 ft (137.2m) of wire rope	312	141	–93	–43	405	184
Front winch roller	77	35	–22	–10	99	45
Remove rear winch rope (450 ft)	–365	–166	161	73	–526	–239
Remove front winch rope (450 ft)	–365	–166	120	54	–485	–220
360° Mechanical House Lock	60	27	–2	–1	62	28
Add 2,000 lb of counterweight (6,700 lb total)	2,000	907	–868	–394	2,868	1 801
Fly brackets to boom base section for fly options	116	53	62	28	54	24
28.5 ft (8.69m) offsettable fly w/ATB weight (stowed)	1,184	537	839	381	345	156
28.5 – 51 ft (8.69 – 15.54m) offsettable fly w/ATB weight (stowed)	1,757	797	1,141	518	616	279
Floodlight to front of boom base section	10	5	13	6	–3	–1
25 – ton (22.7mt) hook block stowed behind bumper (3 – sheaves)	670	304	784	356	–114	–52
40 – ton (36.3mt) hook block stowed behind bumper (4 – sheaves)	780	354	913	414	–133	–60
Hookball to front bumper	360	163	421	191	–61	–28
Auxiliary arm w/ATB switch to boomhead	110	50	153	69	–43	–20

¹ Adjust gross vehicle weight & axle loading according to component weight. Note: All weights are ± 3%

Axle	Maximum Load @ 65 mph (105km/h)
Front	22,700 lb (10 297kg) – steel or aluminum disc wheels
Rear	44,000 lb (19 958kg) – steel or aluminum disc wheels



WARNING

READ AND UNDERSTAND THE OPERATOR'S AND SAFETY MANUALS AND THE FOLLOWING INSTRUCTIONS AND RATED LIFTING CAPACITIES BEFORE OPERATING THE CRANE. OPERATION WHICH DOES NOT FOLLOW THESE INSTRUCTIONS MAY RESULT IN AN ACCIDENT.

OPERATING INSTRUCTIONS

GENERAL:

1. Rated lifting capacities in pounds as shown on lift charts pertain to this crane as originally manufactured and normally equipped. Modifications to the crane or use of optional equipment other than that specified can result in a reduction of capacity.
2. Construction equipment can be dangerous if improperly operated or maintained. Operation and maintenance of this crane must be in compliance with the information in the Operator's, Parts, and Safety Manuals supplied with this crane. If these manuals are missing, order replacements through the distributor.
3. The operator and other personnel associated with this crane shall read and fully understand the latest applicable American National Standards ASME B30.5 safety standards for cranes.
4. The rated lifting capacities are based on crane standing level on firm supporting surface.

SET UP:

1. The crane shall be leveled on a firm supporting surface. Depending on the nature of the supporting surface, it may be necessary to have structural supports under the outrigger pontoons or tires to spread the load to a larger bearing surface.
2. When making lifts on outriggers, all tires must be free of supporting surface. All outrigger beams must be extended to the same length; fully retracted, intermediate extended, or fully extended. The front bumper outrigger must be properly extended.
3. When making lifts on tires, they must be inflated to the recommended pressure. (See Operation note 20 and Tire Inflation.)
4. Before swinging boom to over side position on tires, boom sections must be fully retracted.
5. For required parts of line, see Wire Rope Capacity and Winch Performance.
6. Before setting up on intermediate outriggers, retracted outriggers, or tires, refer to Working Range Diagrams and rated lifting capacities to determine allowable crane configurations.

OPERATION:

1. Rated lifting capacities at rated radius shall not be exceeded. Do not tip the crane to determine allowable loads. For concrete bucket operation, weight of bucket and load shall not exceed 80% of rated lifting capacities. For clamshell bucket operation, weight of bucket and bucket contents is restricted to a maximum weight of 6,000 pounds or 80% of rated lifting capacity, whichever is less. For magnet operation, weight of magnet and load is restricted to a maximum weight of 6,000 pounds or 80% of rated lifting capacity, whichever is less. For clamshell and magnet operation, maximum boom length is restricted to 50 ft and the boom angle is restricted to a minimum of 35 degrees. Lifts with either fly erected is prohibited for both clam and magnet operation.
2. Rated lifting capacities shown on fully extended outriggers do not exceed 85% of the tipping loads. Rated lifting capacities shown on intermediate extended or fully retracted outriggers are determined by the formula, rated load = (tipping load – 0.1 X load factor)/1.25. Rated lifting capacities shown on tires do not exceed 75% of the tipping loads. Tipping loads are determined by SAE crane stability test code J–765.
3. Rated lifting capacities in the shaded areas are based on structural strength or hydraulic limitations and have been tested to meet minimum requirements of SAE J–1063 cantilevered boom crane structures—method of test. The rated lifting capacities in non–shaded areas are based on stability ratings. Some capacities are limited by a maximum obtainable 78° boom angle.
4. Rated lifting capacities include the weight of the hook ball/block, slings, bucket, magnet and auxiliary lifting devices. Their weights must be subtracted from the listed rated capacity to obtain the net load which can be lifted. Rated lifting capacities include the deduct for either fly stowed on the base of the boom. For deducts of either fly erected, but not used, see Capacity Deductions For Auxiliary Load Handling Equipment.



5. Rated lifting capacities are based on freely suspended loads. No attempt shall be made to move a load horizontally on the ground in any direction.
6. Rated lifting capacities are for lift crane service only.
7. Do not operate at radii or boom lengths (minimum or maximum) where capacities are not listed. At these positions, the crane can tip or cause boom failure.
8. The maximum loads which can be telescoped are not definable because of variation in loadings and crane maintenance, but it is permissible to attempt retraction and extension within the limits of the applicable load rating chart.
9. For main boom capacities when either boom length or radius or both are between values listed, proceed as follows:
 - a.. For boom lengths not listed, use rating for next longer boom length or next shorter boom length, whichever is smaller.
 - b.. For load radii not listed, use rating for next larger radius.
10. The user shall operate at reduced ratings to allow for adverse job conditions, such as: soft or uneven ground, out of level conditions, wind, side loads, pendulum action, jerking or sudden stopping of loads, hazardous conditions, experience of personnel, traveling with loads, electrical wires, etc. Side load on boom or fly is dangerous and shall be avoided.
11. Rated lifting capacities do not account for wind on suspended load or boom. Rated capacities and boom length shall be appropriately reduced as wind velocity approaches or exceeds 20 mph.
12. When making lifts with auxiliary head machinery, the effective length of the boom increases by 2 ft.
13. Power sections of boom must be extended in accordance with boom mode "A" or "B". In boom mode "B" all power sections must be extended or retracted equally.
14. The least stable rated working area depends on the configuration of the crane set up.
15. Rated lifting capacities are based on correct reeving. Deduction must be made for excessive reeving. Any reeving over minimum required (see Wire Rope Capacity) is considered excessive and must be accounted for when making lifts. Use Working Range Diagram to estimate the extra feet of rope then deduct 1 lb. for each extra foot of wire rope before attempting to lift a load.
16. The loaded boom angle combined with the boom length give only an approximation of the operating radius. The boom angle, before loading, should be greater to account for deflection. For main boom capacities, the loaded boom angle is for reference only. For fly capacities, the load radius is for reference only.
17. For fly capacities with main boom length less than 105 ft and greater than 80 ft, the rated capacities are determined by the boom angle using the 105 ft boom and fly chart. For angles not shown use the next lower boom angle to determine the rated capacity.
18. For fly capacities with main boom length less than 105 ft and greater than 80 ft, the rated capacities are determined by the boom angle using the 105 ft boom and fly chart. For angles not shown use the next lower boom angle to determine the rated capacity.
19. For fly capacities with main boom length less than 80 ft, the rated capacities are determined by the boom angle only using the 80 ft boom and fly chart. For angles not shown, use the next lower boom angle to determine the rated capacity.
20. The 33 ft boom length structural lifting capacities are based on boom fully retracted. If the boom is not fully retracted, do not exceed capacities shown for the 40 ft boom length.
21. Rated lifting capacities on tires depend on tire capacity, condition of tires, and tire air pressure. On tire capacities require lifting from main boom head only on a smooth and level surface. The boom must be centered over the rear of the crane with two position travel swing lock engaged and the load must be restrained from swinging. Rated lifting capacities on tires are limited to creep speed. For correct tire pressure, see Tire Inflation.

DEFINITIONS:

1. Load Radius: Horizontal distance from a projection of the axis of rotation to the supporting surface, before loading, to the center of the vertical hoist line or tackle with load applied.
2. Loaded Boom Angle: \angle° The angle between the boom base section and horizontal with freely suspended load at the rated radius.
3. Working Area: Area measured in a circular arc about the center line of rotation as shown on the Working Area Diagram.
4. Freely Suspended Load: Load hanging free with no direct external force applied except by the hoist line.
5. Side Load: Horizontal side force applied to the lifted load either on the ground or in the air.
6. No Load Stability Limit: The radius or boom angle beyond which it is not permitted to position the boom because the crane can overturn without any load on the hook.
7. Load Factor: Load applied at the boom tip which gives the same moment effect as the boom mass.
8. Creep: Crane movement not exceeding 200 ft in a 30 minute period and 1 mph maximum speed.

BOOM EXTENSION

Boom Mode "A"
Only inner mid section telescopes

Boom Length (ft)

33
40
50
57

Inner Mid Section 288" Stroke Base Section

Boom Mode "B"
Inner mid, outer mid and tip sections telescope simultaneously.

Boom Length (ft)

33
40
50
60
70
80
90
100
105

Tip Section 288" Stroke Outer Mid Section 288" Stroke Inner Mid Section 288" Stroke Base Section

TIRE INFLATION

Tire Size	Operation	Tire Pressure (psi)
11 R 22.5	Creep	120
275/80 R 22.5	Creep	120

PONTOON LOADINGS

Maximum Pontoon Load:	Maximum Pontoon Ground Bearing Pressure:
61,750 lb	137 psi

CAPACITY DEDUCTIONS FOR AUXILIARY LOAD HANDLING EQUIPMENT

Load Handling Equipment:	(lb)
Auxiliary Head Attached	100
25-ton quick reeve 3 sheave hook block (see hook block for actual weight)	670
40-ton quick reeve 4 sheave hook block (see hook block for actual weight)	780
8.5-ton hook ball (see hook ball for actual weight)	360
Lifting From Main Boom With:	(lb)
28.5 ft or 51 ft fly stowed on base (see operation note 4)	0
28.5 ft offset fly erected but not used	2,600
51 f. offset fly erected but not used	4,800
Lifting From 28.5 ft Offset Fly With:	
22.5 ft fly tip erected but not used	PROHIBITED
22.5 ft fly tip stowed on 28.5 ft offset fly	PROHIBITED
Note: Capacity deductions are for Link-Belt supplied equipment only.	

WINCH PERFORMANCE

Wire Rope Layer	Winch Line Pulls		Drum Rope Capacity (ft)	
	Two Speed Winch		Layer	Total
	Low Speed Available" (lb)	High Speed Available" (lb)		
1	13,010	6,418	77	77
2	11,768	5,805	85	162
3	10,742	5,299	93	255
4	9,881	4,874	101	356
5	9,148	4,513	109	465

*Maximum lifting capacity: Type RB Rope=9,080, Type ZB Rope=11,080

WIRE ROPE CAPACITY

Maximum Lifting Capacities Based On Wire Rope Strength			
Parts of Line	5/8"		Notes
	Type RB	Type ZB	
1	9,080	11,080	Capacities shown are in pounds and working loads must not exceed the ratings on the capacity charts in the Crane Rating Manual. Study Operator's Manual for wire rope inspection procedures and single part of line applications.
2	18,160	22,160	
3	27,240	33,240	
4	36,320	44,320	
5	45,400	55,400	
6	54,480	66,480	
7	63,560	77,560	
8	72,640	88,640	
9	81,720	—	
LBCE	DESCRIPTION		
TYPE RB	18 X 19 Rotation Resistant - Compact Strand, High Strength Preformed, Right Regular Lay		
TYPE ZB	36 X 7 Rotation Resistant - Extra Improved Plow Steel - Right Regular Lay		

HYDRAULIC CIRCUIT PRESSURE SETTINGS

Function	Pressure (psi)
Front And Rear Winch	3,100
Outriggers	3,000
Boom Hoist	3,350
Telescope	3,000
Swing	1,500
Steering	2,000
Bumper Outrigger	650
Pilot Control	500

WORKING AREAS

HTC on Outriggers

HTC on Tires

Note: These Lines Determine The Limiting Position Of Any Load For Operation Within Working Areas Indicated.



WORKING RANGE DIAGRAM

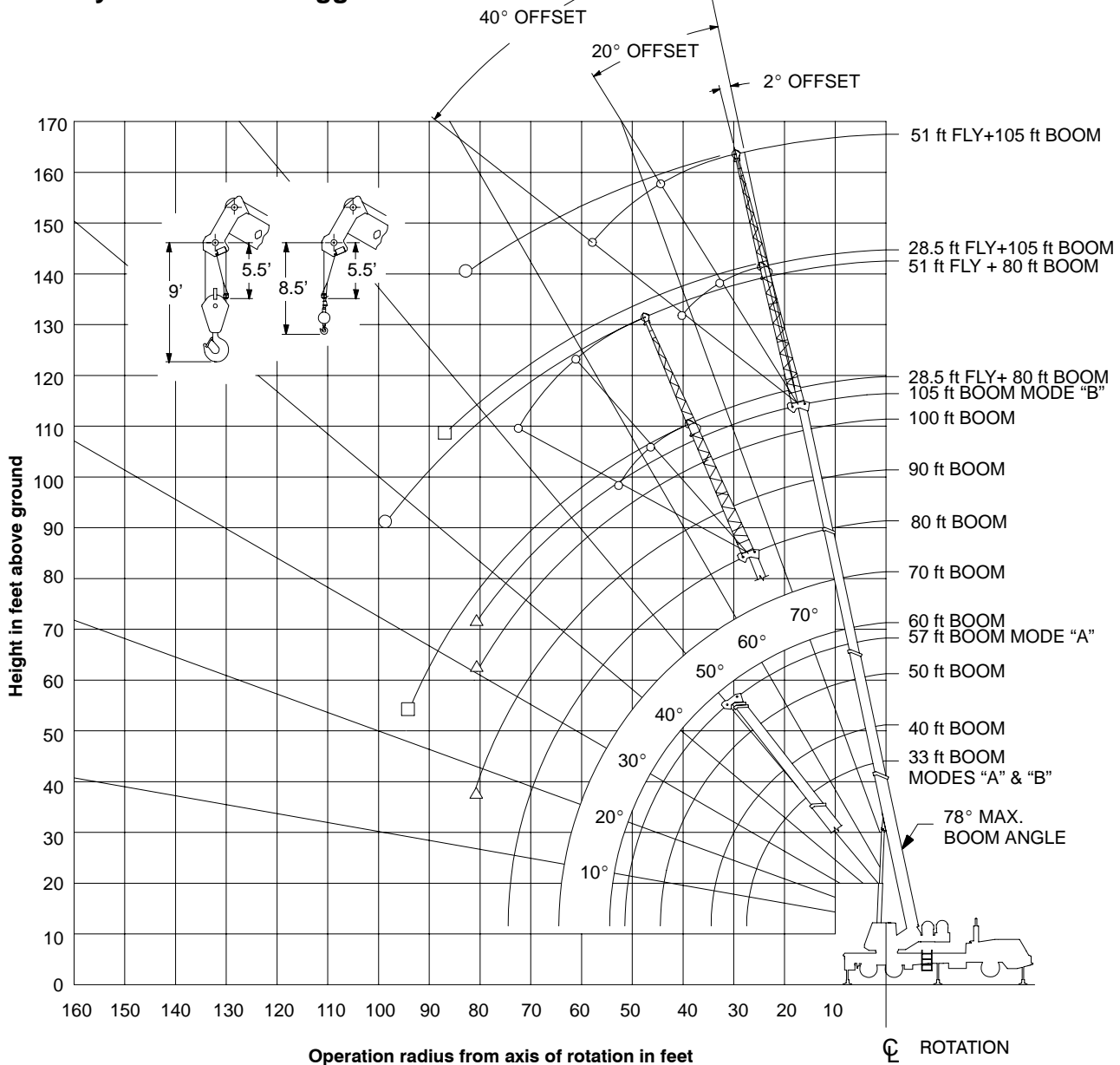
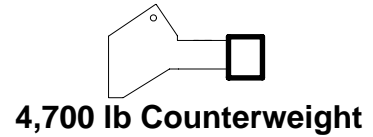
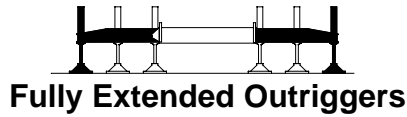

- Denotes Main Boom + 51' Offset Fly-Boom Mode "B"
- Denotes Main Boom + 28.5' Offset Fly-Boom Mode "B"
- △ Denotes Main Boom - Boom Mode "B"

Note: Boom and fly geometry shown are for unloaded condition and crane standing level on firm supporting surface. Boom deflection, subsequent radius and boom angle change must be accounted for when applying load to hook.



WARNING

Do Not Lower The Boom Below The Minimum Boom Angle For No Load Stability As Shown In The Lift Charts For The Boom Lengths Given. Loss Of Stability Will Occur Causing A Tipping Condition.



Rated Lifting Capacities In Pounds Fully Extended Outriggers See Set Up Note 2

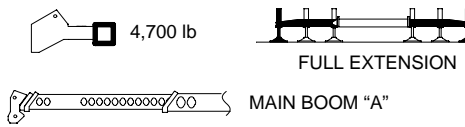

Load Radius (ft)	33 ft			40 ft		
	∠°	360°	Over Rear	∠°	360°	Over Rear
9	68.0	80,000	80,000			
10	66.0	72,300	72,300	70.5	72,300	72,300
12	62.0	65,500	65,500	67.5	65,200	65,200
15	55.5	55,600	55,600	62.5	55,100	55,100
20	43.5	38,400	38,500	54.0	37,900	37,900
25	26.5	25,600	25,600	43.5	25,300	25,300
30				31.0	18,100	18,100
Min.Bm Ang/Cap	0 (27.5)	18,400	18,400	0 (34.5)	13,700	13,700
Load Radius (ft)	50 ft			57 ft		
	∠°	360°	Over Rear	∠°	360°	Over Rear
10	75.0	67,500	67,500	77.0	43,800	43,800
12	73.0	61,200	61,200	75.0	43,800	43,800
15	69.0	53,400	53,400	72.0	42,100	42,100
20	62.5	37,300	37,300	66.5	34,300	34,300
25	55.5	24,900	24,900	60.5	24,600	24,600
30	48.0	17,900	17,900	54.5	17,600	17,600
35	39.0	13,200	13,200	47.5	13,100	13,100
40	27.5	9,800	10,000	40.0	9,600	9,900
45				30.5	7,200	7,600
50				16.0	5,200	5,700
Min.Bm Ang/Cap	0 (44.5)	7,400	7,800	0 (51.5)	4,700	5,200

Rated Lifting Capacities In Pounds Fully Extended Outriggers See Set Up Note 2

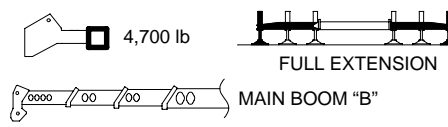

Load Radius (ft)	33 ft			40 ft			50 ft		
	∠°	360°	Over Rear	∠°	360°	Over Rear	∠°	360°	Over Rear
9	68.0	80,000	80,000						
10	66.0	72,300	72,300	70.5	35,000	35,000	74.5	35,000	35,000
12	62.0	65,500	65,500	67.5	35,000	35,000	72.5	35,000	35,000
15	55.5	55,600	55,600	62.5	35,000	35,000	68.5	35,000	35,000
20	43.5	38,400	38,500	54.0	35,000	35,000	62.5	35,000	35,000
25	26.5	25,600	25,600	43.5	26,300	26,300	55.5	26,800	26,800
30				31.0	19,000	19,000	47.5	19,600	19,600
35							39.0	14,900	14,900
40							27.5	11,500	11,600
Min.Bm Ang/Cap	0 (27.5)	18,400	18,400	0 (34.5)	13,500	13,500	0 (44.5)	9,100	9,200
Load Radius (ft)	60 ft			70 ft			80 ft		
	∠°	360°	Over Rear	∠°	360°	Over Rear	∠°	360°	Over Rear
10	77.5	35,000	35,000						
12	75.5	35,000	35,000						
15	72.5	35,000	35,000	75.5	35,000	35,000			
20	67.5	35,000	35,000	71.5	35,000	35,000	74.5	30,700	30,700
25	62.0	27,000	27,000	67.0	27,100	27,100	71.0	26,400	26,400
30	56.5	19,800	19,800	62.5	19,900	19,900	66.5	20,000	20,000
35	50.0	15,200	15,200	57.5	15,300	15,300	62.5	15,400	15,400
40	43.5	11,800	11,900	52.0	12,000	12,100	58.0	12,100	12,200
45	35.0	9,300	9,500	46.5	9,400	9,700	53.5	9,500	9,800
50	25.0	7,300	7,700	40.0	7,500	7,900	48.5	7,600	8,100
55				32.5	6,000	6,400	43.5	6,100	6,600
60				23.0	4,800	5,200	37.5	5,000	5,400
65							30.5	4,000	4,400
70							21.5	3,100	3,600
Min.Bm Ang/Cap	0 (54.5)	5,900	6,300	0 (64.5)	3,800	4,300	0 (74.5)	2,500	2,900
Load Radius (ft)	90 ft			100 ft			105 ft		
	∠°	360°	Over Rear	∠°	360°	Over Rear	∠°	360°	Over Rear
20	77.0	27,400	27,400						
25	73.5	23,500	23,500	76.0	21,000	21,000			
30	70.0	20,100	20,100	73.0	18,700	18,700	74.0	17,500	17,500
35	66.5	15,500	15,500	69.5	15,600	15,600	71.0	15,600	15,600
40	62.5	12,200	12,300	66.5	12,200	12,300	68.0	12,200	12,400
45	58.5	9,600	9,900	63.0	9,600	10,000	64.5	9,700	10,000
50	54.5	7,700	8,100	59.5	7,800	8,200	61.5	7,800	8,200
55	50.5	6,200	6,700	55.5	6,300	6,800	58.0	6,300	6,800
60	46.0	5,000	5,500	52.0	5,100	5,600	54.5	5,100	5,600
65	41.0	4,100	4,500	48.0	4,100	4,600	50.5	4,100	4,600
70	35.5	3,200	3,700	43.5	3,300	3,800	47.0	3,300	3,800
75	29.0	2,500	3,000	39.0	2,600	3,100	42.5	2,600	3,100
80	20.5	1,900	2,400	34.0	2,000	2,500	38.0	2,000	2,500
Min.Bm Ang/Cap	16.5 (81.8)			30.5 (82.6)			35.0 (83.3)		

Note: Refer To "Capacity Deductions For Auxiliary Load Handling Equipment".
 ∠ Loaded Boom Angle In Degrees.
 () Reference Radius For Min. Boom Angle Capacities (Shown in Parenthesis) Are In Feet.

Note: Refer To "Capacity Deductions For Auxiliary Load Handling Equipment".
 ∠ Loaded Boom Angle In Degrees.
 () Reference Radius For Min. Boom Angle Capacities (Shown in Parenthesis) Are In Feet.

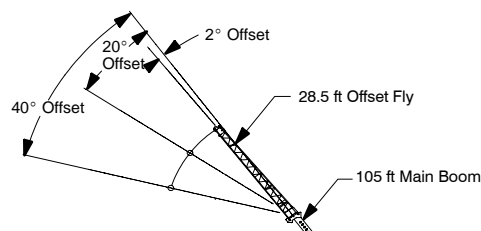
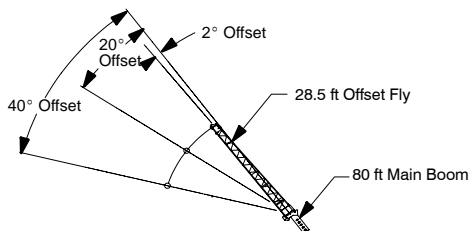

Rated Lifting Capacities In Pounds Fully Extended Outriggers See Set Up Note 2

FULL EXTENSION 4,700 lb

Load Radius (ft)	2° Offset		20° Offset		40° Offset	
	∠°	360°	∠°	360°	∠°	360°
25	77.0	15,200				
30	74.5	13,900				
35	72.0	11,900	76.0	8,700		
40	69.0	11,000	73.0	8,100	77.0	6,100
45	66.0	10,300	70.0	7,600	74.0	5,800
50	63.0	8,900	67.0	7,100	71.0	5,600
55	59.5	7,300	64.0	6,700	67.5	5,400
60	56.5	6,100	61.0	6,400	64.0	5,300
65	53.0	5,000	57.5	5,600	60.5	5,100
70	49.0	4,200	53.5	4,600	57.0	5,000
75	45.0	3,500	49.5	3,800	52.5	4,100
80	41.0	2,900	45.0	3,200	47.5	3,400
85	36.5	2,300	40.5	2,600	42.0	2,700
90	31.0	1,900	35.0	2,000		
95	25.0	1,400	28.0	1,600		

Rated Lifting Capacities In Pounds Fully Extended Outriggers See Set Up Note 2

FULL EXTENSION 4,700 lb

Load Radius (ft)	2° Offset		20° Offset		40° Offset	
	∠°	360°	∠°	360°	∠°	360°
35	76.5	9,000				
40	74.5	9,000	78.0*	7,900		
45	72.5	8,800	76.0	7,500		
50	70.0	7,900	73.5	7,200	76.5	5,700
55	67.5	7,000	71.0	6,600	74.0	5,500
60	65.0	5,800	69.0	6,100	71.5	5,400
65	62.5	4,800	66.0	5,400	69.5	5,200
70	59.5	3,900	63.5	4,500	66.5	4,900
75	56.5	3,200	60.5	3,700	63.5	4,100
80	54.0	2,600	57.5	3,000	60.5	3,400
85	51.0	2,100	54.5	2,400	57.0	2,700
90			51.5	1,900	53.5	2,200
95			48.0	1,500	50.0	1,700

WARNING

Do Not Lower 28.5 ft Offset Fly In Working Position Below 23.5° Main Boom Angle Unless Main Boom Length Is 74 ft Or Less, Since Loss Of Stability Will Occur Causing A Tipping Condition.

WARNING

Do Not Lower 28.5 ft Offset Fly In Working Position Below 47° Main Boom Angle Unless Main Boom Length Is 74 ft Or Less, Since Loss Of Stability Will Occur Causing A Tipping Condition.

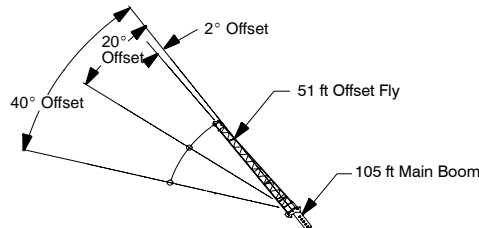
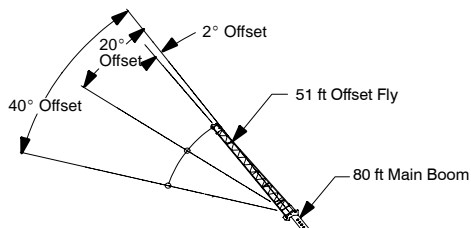

Rated Lifting Capacities In Pounds Fully Extended Outriggers See Set Up Note 2

FULL EXTENSION 4,700 lb

Load Radius (ft)	2° Offset		20° Offset		40° Offset	
	∠°	360°	∠°	360°	∠°	360°
35	76.0	7,400				
40	74.0	6,700				
45	71.5	6,100	78.0*	4,200		
50	69.5	5,600	76.0	3,900		
55	67.0	5,100	73.5	3,700		
60	64.5	4,700	71.0	3,500	77.0	2,700
65	62.0	4,300	68.5	3,300	74.5	2,600
70	59.5	4,000	66.0	3,100	72.0	2,500
75	57.0	3,800	63.0	2,900	69.0	2,400
80	54.0	3,500	60.5	2,800	66.0	2,300
85	51.0	2,900	57.5	2,700	62.5	2,300
90	47.5	2,500	54.5	2,600	59.5	2,200
95	44.5	2,000	51.0	2,500	55.5	2,200
100	41.0	1,700	47.5	2,000	51.5	2,200
105			43.0	1,700	47.0	1,900
110			38.5	1,300	41.0	1,400

Rated Lifting Capacities In Pounds Fully Extended Outriggers See Set Up Note 2

FULL EXTENSION 4,700 lb

Load Radius (ft)	2° Offset		20° Offset		40° Offset	
	∠°	360°	∠°	360°	∠°	360°
40	77.5	5,800				
45	75.5	5,700				
50	74.0	5,400				
55	72.0	5,100	77.5	3,700		
60	70.5	4,800	75.5	3,500		
65	68.5	4,500	73.5	3,400		
70	66.5	4,200	71.5	3,200	76.5	2,500
75	64.0	3,700	69.5	3,100	74.5	2,400
80	62.0	3,100	67.5	2,900	72.5	2,400
85	59.5	2,500	65.5	2,800	70.5	2,300
90	57.0	2,100	63.5	2,700	68.0	2,300
95			60.5	2,200	65.5	2,200
100			58.0	1,800	63.0	2,200
105					60.0	1,800
110					57.0	1,400

WARNING

Do Not Lower 51 ft Offset Fly In Working Position Below 37.5° Main Boom Angle Unless Main Boom Length Is 67 ft Or Less, Since Loss Of Stability Will Occur Causing A Tipping Condition.

WARNING

Do Not Lower 51 ft Offset Fly In Working Position Below 55.5° Main Boom Angle Unless Main Boom Length Is 67 ft Or Less, Since Loss Of Stability Will Occur Causing A Tipping Condition.

Note: Refer To "Capacity Deductions For Auxiliary Load Handling Equipment".

Note: Refer To "Capacity Deductions For Auxiliary Load Handling Equipment".

∠ Loaded Boom Angle In Degrees. * This Capacity Based On Maximum Obtainable Boom Angle.

∠ Loaded Boom Angle In Degrees. * This Capacity Based On Maximum Obtainable Boom Angle.



WORKING RANGE DIAGRAM

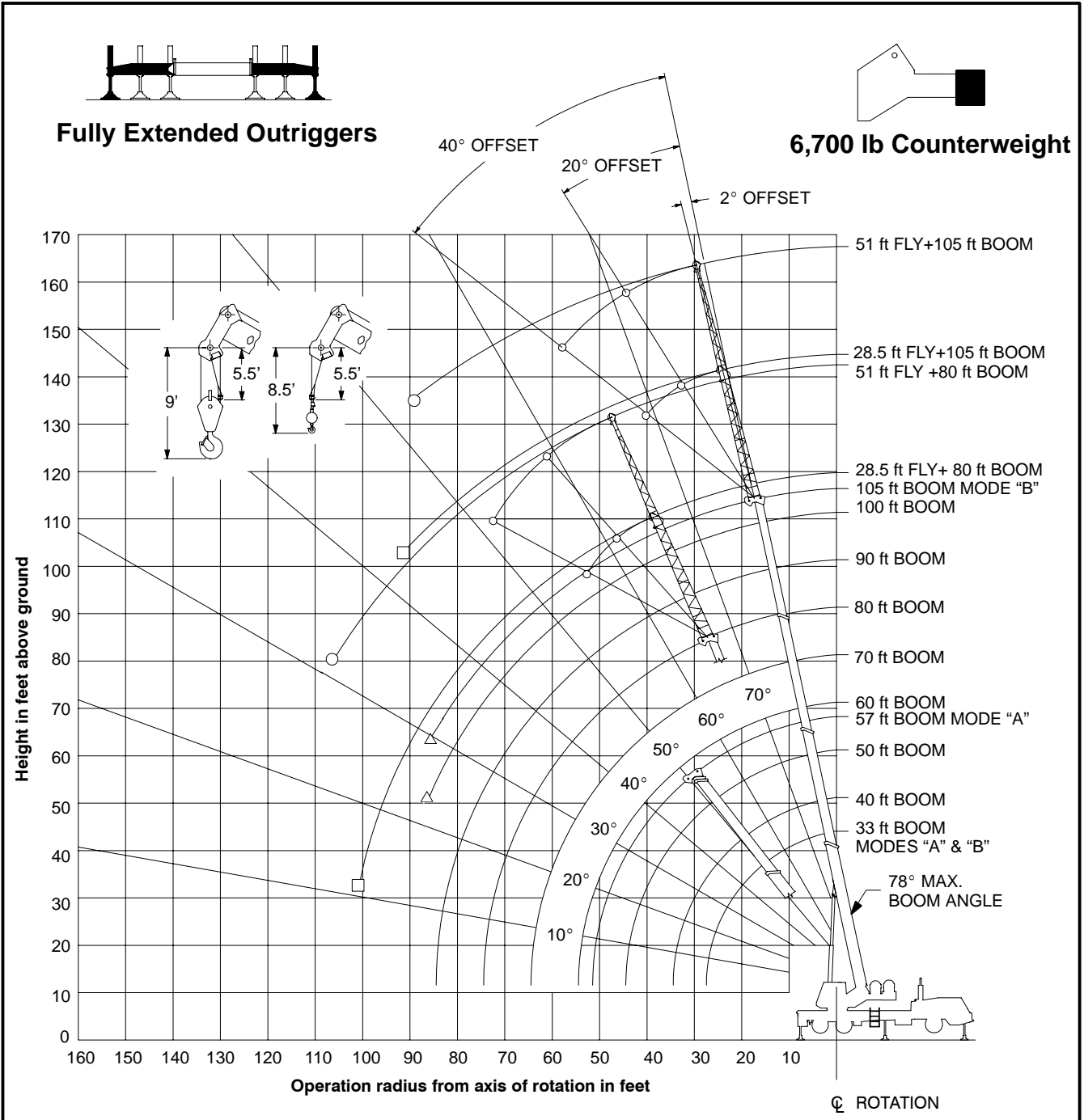

Fully Extended Outriggers

6,700 lb Counterweight

- Denotes Main Boom + 51' Offset Fly-Boom Mode "B"
- Denotes Main Boom + 28.5' Offset Fly-Boom Mode "B"
- △ Denotes Main Boom - Boom Mode "B"

Note: Boom and fly geometry shown are for unloaded condition and crane standing level on firm supporting surface. Boom deflection, subsequent radius and boom angle change must be accounted for when applying load to hook.

⚠ WARNING

Do Not Lower The Boom Below The Minimum Boom Angle For No Load Stability As Shown In The Lift Charts For The Boom Lengths Given. Loss Of Stability Will Occur Causing A Tipping Condition.



5426 (#5379 & #6253 consolidated) – 1104 – F8

13

Rated Lifting Capacities In Pounds Fully Extended Outriggers See Set Up Note 2

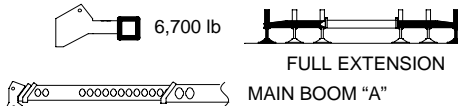

6,700 lb FULL EXTENSION MAIN BOOM "A"

Load Radius (ft)	33 ft			40 ft			Load Radius (ft)
	∠°	360°	Over Rear	∠°	360°	Over Rear	
9	68.0	80,000	80,000				9
10	66.0	72,300	72,300	70.5	72,300	72,300	10
12	62.0	65,800	65,800	67.5	65,500	65,500	12
15	55.5	55,800	55,800	62.5	55,600	55,600	15
20	43.5	40,700	40,800	54.0	40,200	40,200	20
25	26.5	27,200	27,200	44.0	27,000	27,000	25
30				31.0	19,400	19,400	30
Min.Bm Ang./Cap	0 (27.5)	18,400	18,400	0 (34.5)	14,100	14,100	Min.Bm Ang./Cap
Load Radius (ft)	50 ft			57 ft			
	∠°	360°	Over Rear	∠°	360°	Over Rear	
10	75.0	67,500	67,500	77.0	43,800	43,800	
12	73.0	61,200	61,200	75.0	43,800	43,800	
15	69.0	53,400	53,400	72.0	42,100	42,100	
20	62.5	39,600	39,600	66.5	34,300	34,300	
25	55.5	26,600	26,600	60.5	26,300	26,300	
30	48.0	19,100	19,100	54.5	18,900	18,900	
35	39.0	14,300	14,300	47.5	14,200	14,200	
40	27.5	10,900	10,900	40.0	10,800	10,800	
45				30.5	8,200	8,300	
50				16.0	6,100	6,400	
Min.Bm Ang./Cap	0 (44.5)	8,400	8,600	0 (51.5)	5,500	5,900	

Rated Lifting Capacities In Pounds Fully Extended Outriggers See Set Up Note 2

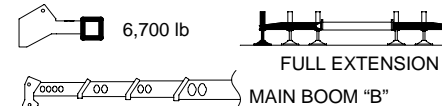

6,700 lb FULL EXTENSION MAIN BOOM "B"

Load Radius (ft)	33 ft			40 ft			50 ft		
	∠°	360°	Over Rear	∠°	360°	Over Rear	∠°	360°	Over Rear
9	68.0	80,000	80,000						
10	66.0	72,300	72,300	70.5	35,000	35,000	74.5	35,000	35,000
12	62.0	65,800	65,800	67.5	35,000	35,000	72.5	35,000	35,000
15	55.5	55,800	55,800	62.5	35,000	35,000	68.5	35,000	35,000
20	43.5	40,700	40,800	54.0	35,000	35,000	62.5	35,000	35,000
25	26.5	27,200	27,200	43.5	27,900	27,900	55.5	28,400	28,400
30				31.0	20,300	20,300	47.5	20,900	20,900
35							39.0	15,900	15,900
40							27.5	12,500	12,500
Min.Bm Ang./Cap	0 (27.5)	18,400	18,400	0 (34.5)	13,500	13,500	0 (44.5)	9,200	9,200
Load Radius (ft)	60 ft			70 ft			80 ft		
	∠°	360°	Over Rear	∠°	360°	Over Rear	∠°	360°	Over Rear
10	77.5	35,000	35,000						
12	75.5	35,000	35,000						
15	72.5	35,000	35,000	75.5	35,000	35,000			
20	67.5	35,000	35,000	71.5	35,000	35,000	74.5	30,700	30,700
25	62.0	28,600	28,600	67.0	28,700	28,700	71.0	26,400	26,400
30	56.5	21,100	21,100	62.5	21,200	21,200	67.0	21,300	21,300
35	50.0	16,300	16,300	57.5	16,400	16,400	62.5	16,500	16,500
40	43.5	12,800	12,800	52.0	13,000	13,000	58.0	13,100	13,100
45	35.5	10,300	10,300	46.5	10,400	10,500	53.5	10,500	10,600
50	25.0	8,200	8,400	40.0	8,400	8,600	48.5	8,500	8,800
55				32.5	6,800	7,000	43.5	6,900	7,200
60				23.0	5,500	5,800	37.5	5,700	6,000
65							30.5	4,600	4,900
70							22.0	3,700	4,000
Min.Bm Ang./Cap	0 (54.5)	6,500	6,500	0 (64.5)	4,500	4,600	0 (74.5)	3,000	3,300
Load Radius (ft)	90 ft			100 ft			105 ft		
	∠°	360°	Over Rear	∠°	360°	Over Rear	∠°	360°	Over Rear
20	77.0	27,400	27,400						
25	73.5	23,500	23,500	76.0	21,000	21,000	76.5	17,500	17,500
30	70.0	20,500	20,500	73.0	18,700	18,700	74.0	17,500	17,500
35	66.5	16,600	16,600	70.0	16,500	16,500	71.0	15,700	15,700
40	62.5	13,200	13,200	66.5	13,200	13,200	68.0	13,300	13,300
45	59.0	10,600	10,700	63.0	10,600	10,700	64.5	10,700	10,800
50	55.0	8,600	8,800	59.5	8,700	8,900	61.5	8,700	8,900
55	50.5	7,000	7,300	56.0	7,100	7,400	58.0	7,100	7,400
60	46.0	5,700	6,100	52.0	5,800	6,100	54.5	5,800	6,200
65	41.0	4,700	5,000	48.0	4,800	5,100	51.0	4,800	5,200
70	35.5	3,800	4,200	44.0	3,900	4,200	47.0	3,900	4,300
75	29.0	3,100	3,400	39.0	3,200	3,500	43.0	3,200	3,500
80	20.5	2,400	2,800	34.0	2,500	2,900	38.5	2,500	2,900
85				28.0	2,000	2,300	33.0	2,000	2,300
Min.Bm Ang./Cap	0 (84.5)	1,900	2,200	23.5 (87.7)			29.5 (88.2)		

Note: Refer To "Capacity Deductions For Auxiliary Load Handling Equipment".

∠ Loaded Boom Angle In Degrees.

() Reference Radius For Min. Boom Angle Capacities (Shown in Parenthesis) Are In Feet.

Note: Refer To "Capacity Deductions For Auxiliary Load Handling Equipment".

∠ Loaded Boom Angle In Degrees.

() Reference Radius For Min. Boom Angle Capacities (Shown In Parenthesis) Are In Feet.



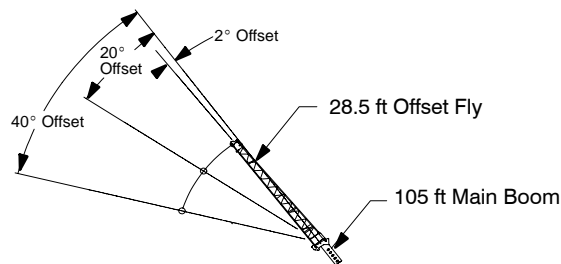
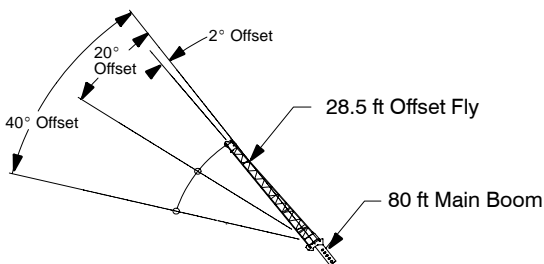

Rated Lifting Capacities In Pounds Fully Extended Outriggers See Set Up Note 2

Load Radius (ft)	2° Offset		20° Offset		40° Offset	
	∠	360°	∠	360°	∠	360°
	25	77.0	15,200			
30	74.5	13,900				
35	72.0	11,900	76.0	8,700		
40	69.0	11,000	73.0	8,100	77.0	6,100
45	66.0	10,300	70.0	7,600	74.0	5,800
50	63.0	9,600	67.0	7,100	71.0	5,600
55	60.0	8,100	64.0	6,700	67.5	5,400
60	56.5	6,800	61.0	6,400	64.0	5,300
65	53.0	5,700	57.5	6,000	60.5	5,100
70	49.5	4,800	53.5	5,200	57.0	5,000
75	45.5	4,000	49.5	4,400	52.5	4,700
80	41.0	3,400	45.5	3,700	48.0	3,900
85	36.5	2,800	40.5	3,000	42.5	3,200
90	31.5	2,300	35.0	2,500		
95	25.0	1,900	28.5	2,000		
100	16.5	1,500	18.0	1,500		

Rated Lifting Capacities In Pounds Fully Extended Outriggers See Set Up Note 2

Load Radius (ft)	2° Offset		20° Offset		40° Offset	
	∠	360°	∠	360°	∠	360°
	35	76.5	9,000			
40	74.5	9,000	78.0°	7,900		
45	72.5	8,800	76.0	7,500		
50	70.0	7,900	73.5	7,200	76.5	5,700
55	67.5	7,200	71.0	6,600	74.0	5,500
60	65.5	6,500	69.0	6,100	71.5	5,400
65	62.5	5,400	66.5	5,700	69.5	5,200
70	60.0	4,500	63.5	5,100	66.5	5,000
75	57.0	3,800	61.0	4,200	64.0	4,600
80	54.0	3,100	58.0	3,500	60.5	3,900
85	51.0	2,500	54.5	2,900	57.5	3,200
90	48.0	2,000	51.5	2,400	54.0	2,600
95	44.5	1,600	48.0	1,900	50.5	2,100
100			44.5	1,500	46.5	1,600

WARNING

Do Not Lower 28.5 ft Offset Fly In Working Position Below 11.5° Main Boom Angle Unless Main Boom Length Is 79 ft Or Less, Since Loss Of Stability Will Occur Causing A Tipping Condition.

WARNING

Do Not Lower 28.5 ft Offset Fly In Working Position Below 43.5° Main Boom Angle Unless Main Boom Length Is 79 ft Or Less, Since Loss Of Stability Will Occur Causing A Tipping Condition.

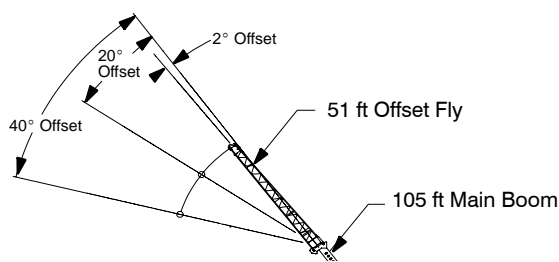
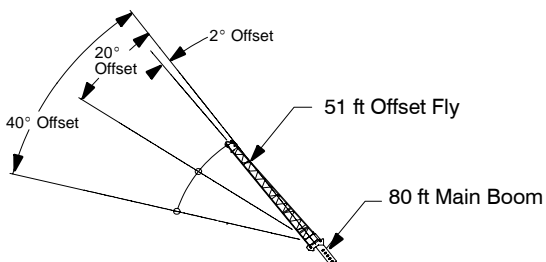

Rated Lifting Capacities In Pounds Fully Extended Outriggers See Set Up Note 2

Load Radius (ft)	2° Offset		20° Offset		40° Offset	
	∠	360°	∠	360°	∠	360°
	35	76.0	7,400			
40	74.0	6,700				
45	71.5	6,100	78.0°	4,200		
50	69.5	5,600	76.0	3,900		
55	67.0	5,100	73.5	3,700		
60	64.5	4,700	71.0	3,500	77.0	2,700
65	62.0	4,300	68.5	3,300	74.5	2,600
70	59.5	4,000	66.0	3,100	72.0	2,500
75	57.0	3,800	63.0	2,900	69.0	2,400
80	54.0	3,500	60.5	2,800	66.0	2,300
85	51.0	3,300	57.5	2,700	62.5	2,300
90	48.0	2,900	54.5	2,600	59.5	2,200
95	44.5	2,400	51.0	2,500	55.5	2,200
100	41.0	2,000	47.5	2,400	51.5	2,200
105	37.0	1,700	43.5	2,000	47.0	2,100
110	33.0	1,400	39.0	1,600	41.5	1,800
115			33.5	1,300		

Rated Lifting Capacities In Pounds Fully Extended Outriggers See Set Up Note 2

Load Radius (ft)	2° Offset		20° Offset		40° Offset	
	∠	360°	∠	360°	∠	360°
	40	77.5	5,800			
45	75.5	5,700				
50	74.0	5,400				
55	72.0	5,100	77.5	3,700		
60	70.5	4,800	75.5	3,500		
65	68.5	4,500	73.5	3,400		
70	66.5	4,200	71.5	3,200	76.5	2,500
75	64.5	3,900	69.5	3,100	74.5	2,400
80	62.0	3,600	67.5	2,900	72.5	2,400
85	60.0	3,000	65.5	2,800	70.5	2,300
90	57.5	2,500	63.5	2,700	68.0	2,300
95	55.0	2,100	61.0	2,600	65.5	2,200
100			58.5	2,200	63.0	2,200
105			55.5	1,800	60.5	2,200
110					57.5	1,700
115					54.0	1,400

WARNING

Do Not Lower 51 ft Offset Fly In Working Position Below 31.5° Main Boom Angle Unless Main Boom Length Is 71 ft Or Less, Since Loss Of Stability Will Occur Causing A Tipping Condition.

WARNING

Do Not Lower 51 ft Offset Fly In Working Position Below 52.5° Main Boom Angle Unless Main Boom Length Is 71 ft Or Less, Since Loss Of Stability Will Occur Causing A Tipping Condition.

Note: Refer To "Capacity Deductions For Auxiliary Load Handling Equipment."

Note: Refer To "Capacity Deductions For Auxiliary Load Handling Equipment".

∠ Loaded Boom Angle In Degrees. * This Capacity Based On Maximum Obtainable Boom Angle.

∠ Loaded Boom Angle In Degrees. * This Capacity Based On Maximum Obtainable Boom Angle.



5426 (#5379 & #6253 consolidated) – 1104 – F8

15

This page intentionally left blank

This page intentionally left blank

5426 (#5379 & #6253 consolidated) – 1104 – F8

17

This page intentionally left blank

5426 (#5379 & #6253 consolidated) – 1104 – F8

Bigge Crane and Rigging Co.

10700 Bigge Avenue
San Leandro, CA 94577
Phone: (888) 337-BIGGE or (510) 638-8100
Fax: (510) 639-4053
Email: info@bigge.com
Web site: www.bigge.com

Link-Belt Construction Equipment Company

Lexington, Kentucky

www.linkbelt.com

©Link-Belt is a registered trademark. Copyright 2004. We are constantly improving our products and therefore reserve the right to change designs and specifications.

