

POTAIN 

HDT80

product guide

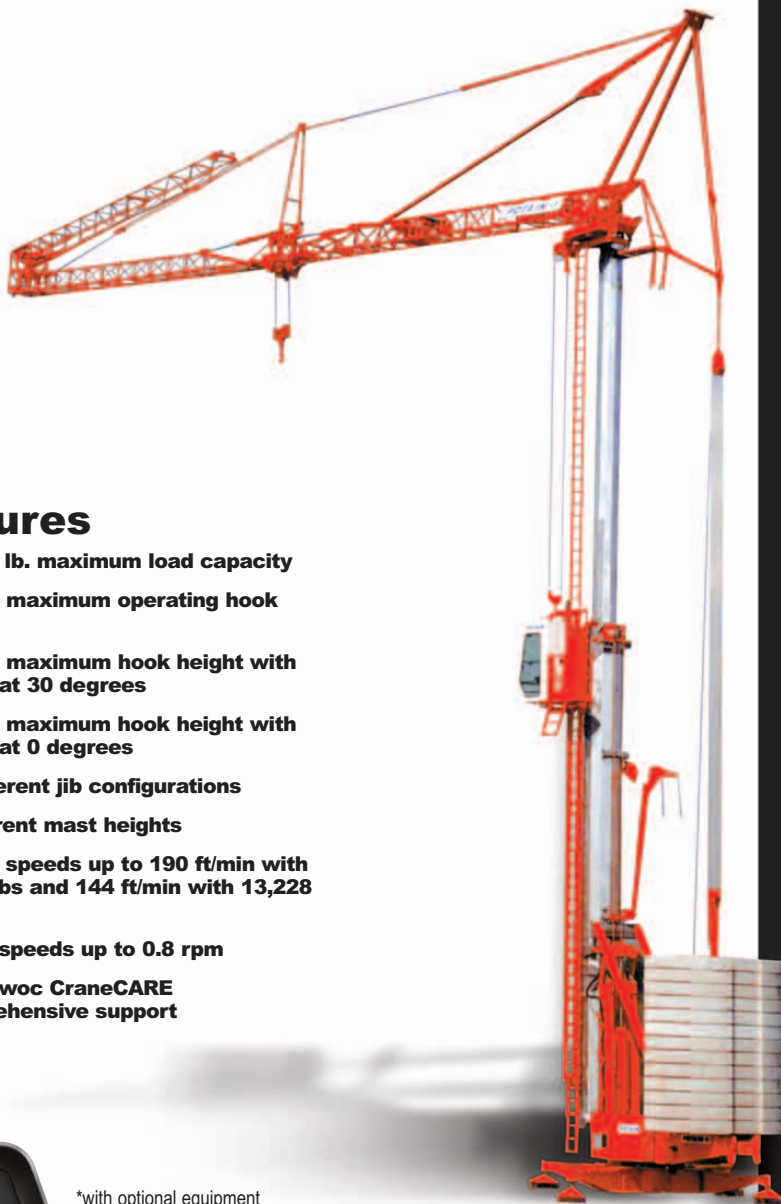

features

- 13,228 lb. maximum load capacity
- 147'-8" maximum operating hook radius
- 176'-2" maximum hook height with jib set at 30 degrees
- 112'-2" maximum hook height with jib set at 0 degrees
- 10 different jib configurations
- 3 different mast heights
- Trolley speeds up to 190 ft/min with 7,937 lbs and 144 ft/min with 13,228 lbs
- Swing speeds up to 0.8 rpm
- Manitowoc CraneCARE comprehensive support

*with optional equipment

contents

Outline Dimensions	2
Outline Dimensions	3
Rated Load Charts	4
Rated Load Charts	5
Mechanical Data	6
Crane Care	7



outline dimensions

2

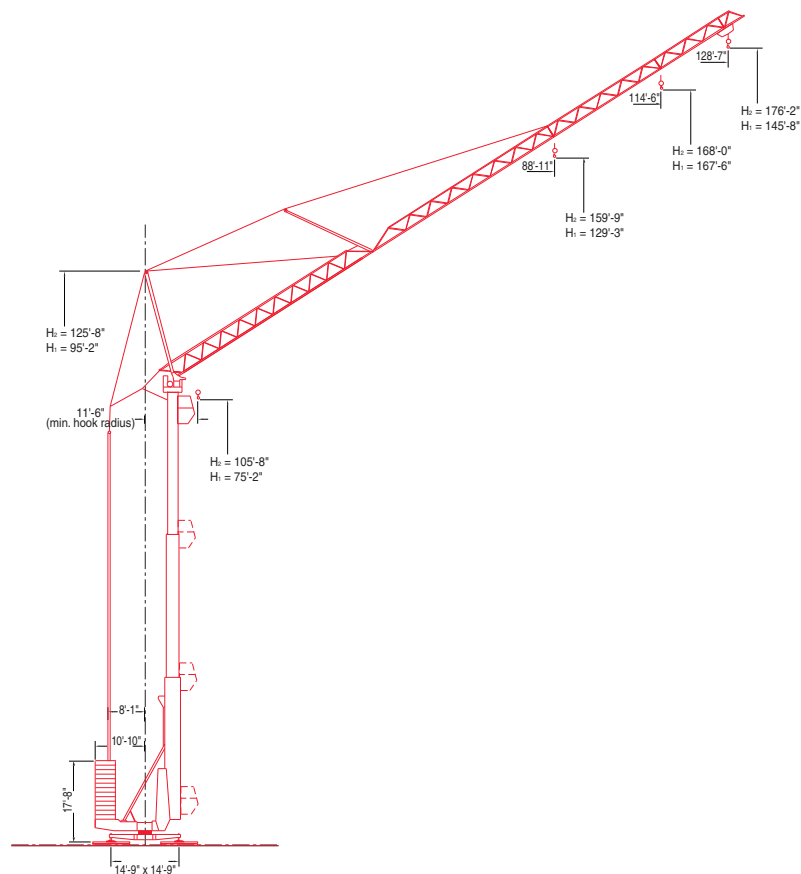
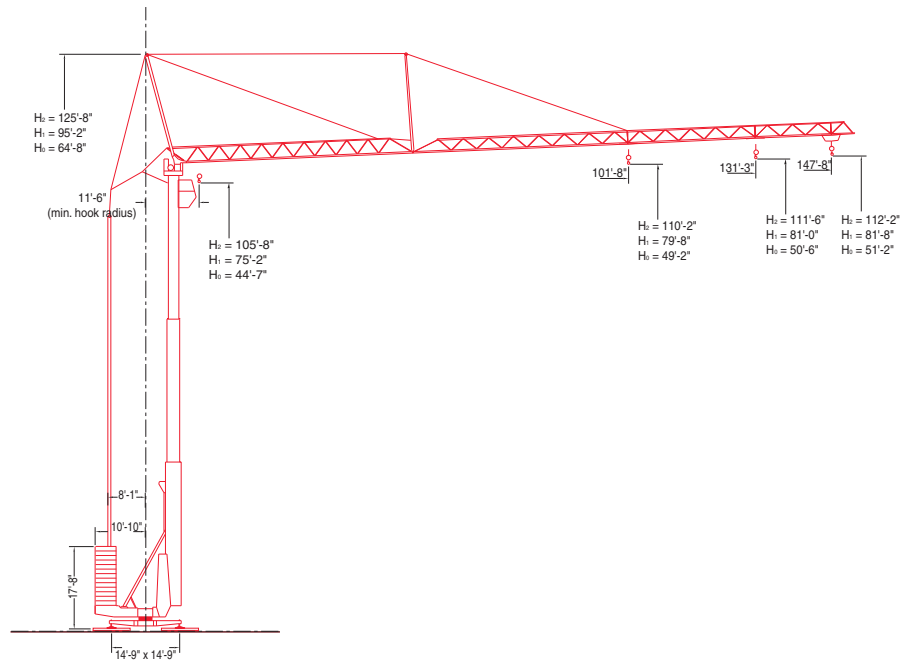

HDT80

POTAIN



outline dimensions

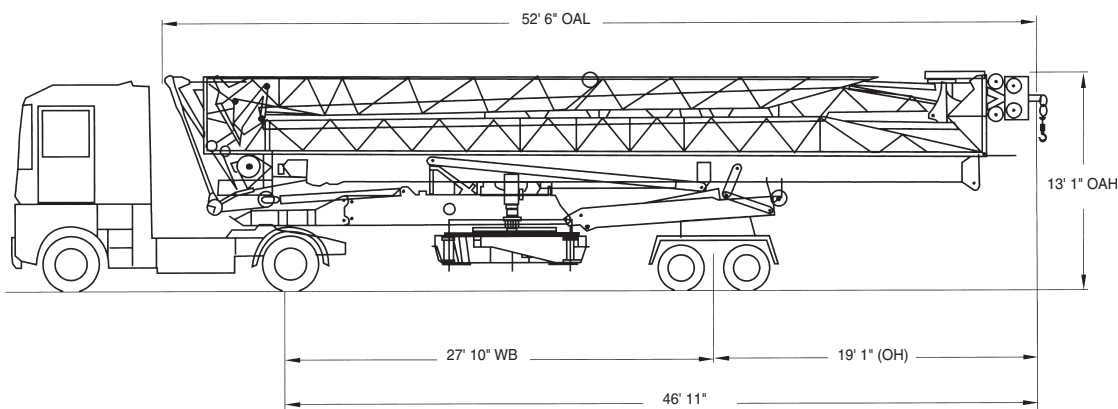
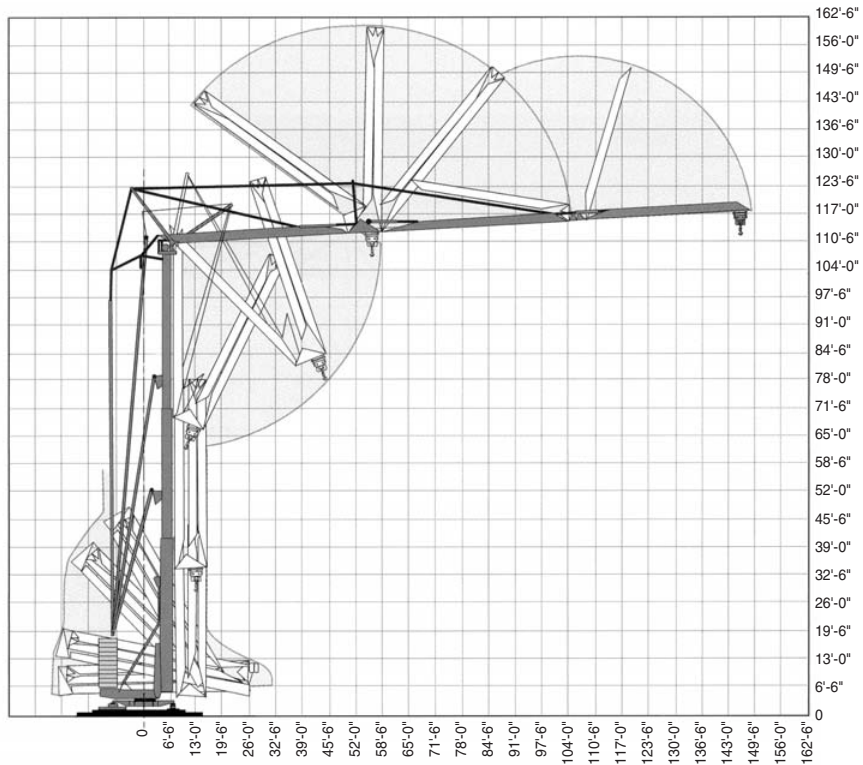

Chassis Data		Weights	
Overall Length (OAL) (in transport position)	52'6"	Total Crane – with Counter Weight	138,687 lb.
Overhang (OH) (in transport position)	19'1"	Total Crane – in Transport	57,992 lb.
Overall Height (OAH) (in transport position)	13'1"	Fifth Wheel	17,861 lb.
Overall Width (in transport position)	8'2"	Rear (drive) Axles	40,131 lb.
		Crane Counterweight	81,705 lb.

HDT80

POTAIN

rated load charts

4

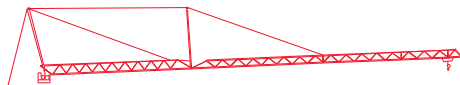

Jib Configuration: L45 with maximum hook reach of 147'-8" set at 0 degrees																
Hook Reach (ft)	11'-6"	43'-8"	49'-3"	55'-9"	65'-7"	72'-2"	77'-9"	82'-0"	88'-7"	98'-5"	105'-0"	114'-10"	121'-5"	131'-3"	137'-10"	147'-8"
Reeving	Capacities (lbs)															
DB-DR	13,228	13,228	11,321	9,678	7,915	7,022	-	5,975	5,423	4,740	4,365	3,880	3,605	3,241	3,031	2,756
SB-SR	6,614	6,614	6,614	6,614	6,614	6,614	6,614	6,195	5,644	4,960	4,586	4,101	3,825	3,461	3,252	2,976

Maximum Hook Heights at Jib Tip: H₂ = 112'-2", H₁ = 81'-8", H₀ = 51'-2"
 Maximum Hook Heights at Jib Foot: H₂ = 105'-8", H₁ = 75'-2", H₀ = 44'-7"

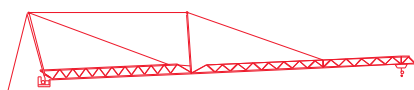

Jib Configuration: L40 with maximum hook reach of 131'-3" set at 0 degrees														
Hook Reach (ft)	11'-6"	46'-11"	49'-3"	55'-9"	65'-7"	72'-2"	82'-0"	84'-8"	88'-7"	98'-5"	105'-0"	114'-10"	121'-5"	131'-3"
Reeving	Capacities (lbs)													
DB-DR	13,228	13,228	12,478	10,681	8,741	7,771	6,636	-	6,030	5,280	4,861	4,332	4,034	3,638
SB-SR	6,614	6,614	6,614	6,614	6,614	6,614	6,614	6,614	6,250	5,501	5,082	4,553	4,255	3,858

Maximum Hook Heights at Jib Tip: H₂ = 111'-6", H₁ = 81'-0", H₀ = 50'-6"
 Maximum Hook Heights at Jib Foot: H₂ = 105'-8", H₁ = 75'-2", H₀ = 44'-7"

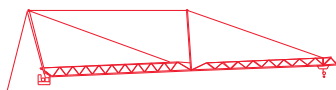

Jib Configuration: L31 with maximum hook reach of 101'-8" set at 0 degrees										
Hook Reach (ft)	11'-6"	53'-10"	55'-9"	65'-7"	72'-2"	82'-0"	88'-7"	97'-5"	98'-5"	101'-8"
Reeving	Capacities (lbs)									
DB-DR	13,228	13,228	12,621	10,351	9,226	7,893	7,187	-	6,316	6,063
SB-SR	6,614	6,614	6,614	6,614	6,614	6,614	6,614	6,614	6,537	6,283

Maximum Hook Heights at Jib Tip: H₂ = 110'-2", H₁ = 79'-8", H₀ = 49'-2"
 Maximum Hook Heights at Jib Foot: H₂ = 105'-8", H₁ = 75'-2", H₀ = 44'-7"

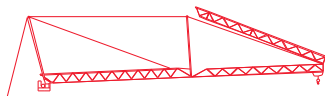

Jib Configuration: L45 with maximum hook reach of 101'-8" set at 0 degrees											
Hook Reach (ft)	11'-6"	46'-3"	49'-3"	55'-9"	65'-7"	72'-2"	82'-0"	83'-0"	88'-7"	98'-5"	101'-8"
Reeving	Capacities (lbs)										
DB-DR	13,228	13,228	12,247	10,483	8,576	7,628	6,504	-	5,908	5,181	4,960
SB-SR	6,614	6,614	6,614	6,614	6,614	6,614	6,614	6,614	6,129	5,401	5,181

Maximum Hook Heights at Jib Tip: H₂ = 110'-2", H₁ = 79'-8", H₀ = 49'-2"
 Maximum Hook Heights at Jib Foot: H₂ = 105'-8", H₁ = 75'-2", H₀ = 44'-7"

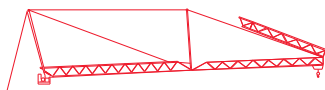

Jib Configuration: L40 with maximum hook reach of 101'-8" set at 0 degrees											
Hook Reach (ft)	11'-6"	48'-7"	49'-3"	55'-9"	65'-7"	72'-2"	82'-0"	87'-7"	88'-7"	98'-5"	101'-8"
Reeving	Capacities (lbs)										
DB-DR	13,228	13,228	12,985	11,133	9,105	8,102	6,923	-	6,283	5,512	5,291
SB-SR	6,614	6,614	6,614	6,614	6,614	6,614	6,614	6,614	6,504	5,732	5,512

Maximum Hook Heights at Jib Tip: H₂ = 110'-2", H₁ = 79'-8", H₀ = 49'-2"
 Maximum Hook Heights at Jib Foot: H₂ = 105'-8", H₁ = 75'-2", H₀ = 44'-7"

HDT80

POTAIN



rated load charts

5

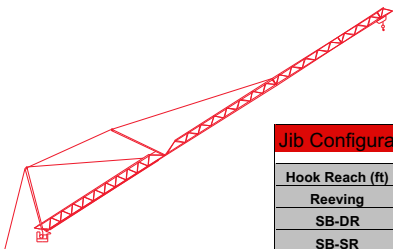

Jib Configuration: L45 with maximum hook reach of 128'-7" set at 30 degrees

Hook Reach (ft)	11'-6"	66'-3"	68'-3"	72'-2"	82'-0"	88'-7"	98'-5"	105'-0"	114'-10"	121'-5"	128'-7"
Reeving	Capacities (lbs)										
SB-DR	6,614	6,614	-	5,941	5,049	4,564	3,968	3,649	3,230	2,987	2,756
SB-SR	6,614	6,614	6,614	6,162	5,269	4,784	4,189	3,869	3,450	3,208	2,976

Maximum Hook Heights at Jib Tip: H₂ = 176'-2", H₁ = 145'-8"
 Maximum Hook Heights at Jib Foot: H₂ = 105'-8", H₁ = 75'-2"

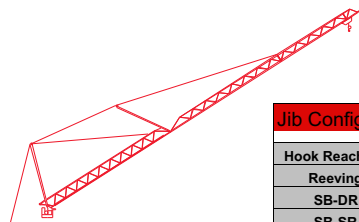

Jib Configuration: L40 with maximum hook reach of 114'-6" set at 30 degrees

Hook Reach (ft)	11'-6"	72'-2"	74'-2"	82'-0"	88'-7"	98'-5"	105'-0"	114'-6"
Reeving	Capacities (lbs)							
SB-DR	6,614	6,614	-	5,611	5,093	4,442	4,079	3,638
SB-SR	6,614	6,614	6,614	5,831	5,313	4,663	4,299	3,858

Maximum Hook Heights at Jib Tip: H₂ = 168'-0", H₁ = 137'-6"
 Maximum Hook Heights at Jib Foot: H₂ = 105'-8", H₁ = 75'-2"

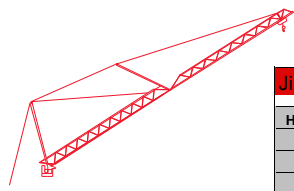

Jib Configuration: L31 with maximum hook reach of 88'-11" set at 30 degrees

Hook Reach (ft)	11'-6"	83'-0"	85'-4"	88'-11"
Reeving	Capacities (lbs)			
SB-DR	6,614	6,614	-	6,063
SB-SR	6,614	6,614	6,614	6,283

Maximum Hook Heights at Jib Tip: H₂ = 159'-9", H₁ = 129'-3"
 Maximum Hook Heights at Jib Foot: H₂ = 105'-8", H₁ = 75'-2"

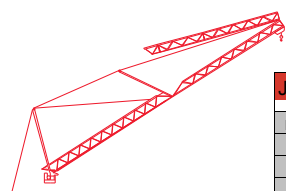

Jib Configuration: L45 with maximum hook reach of 88'-11" set at 30 degrees

Hook Reach (ft)	11'-6"	70'-10"	72'-2"	72'-10"	82'-0"	88'-11"
Reeving	Capacities (lbs)					
SB-DR	6,614	6,614	6,471	-	5,501	4,960
SB-SR	6,614	6,614	6,614	6,614	5,721	5,181

Maximum Hook Heights at Jib Tip: H₂ = 159'-9", H₁ = 129'-3"
 Maximum Hook Heights at Jib Foot: H₂ = 105'-8", H₁ = 75'-2"

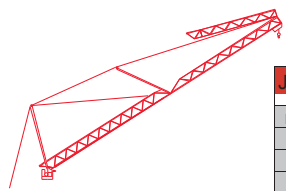

Jib Configuration: L40 with maximum hook reach of 88'-11" set at 30 degrees

Hook Reach (ft)	11'-6"	83'-0"	85'-4"	88'-11"
Reeving	Capacities (lbs)			
SB-DR	6,614	6,614	-	6,063
SB-SR	6,614	6,614	6,614	6,283

Maximum Hook Heights at Jib Tip: H₂ = 159'-9", H₁ = 129'-3"
 Maximum Hook Heights at Jib Foot: H₂ = 105'-8", H₁ = 75'-2"

Reeving Abbreviations:
 DB-DR = double block with double reeving
 SB-DR = single block with double reeving
 SB-SR = single block with single reeving

Note: The minimum hook radius for all jib configurations is 11'-6".

HDT80

POTAIN



mechanical data

6

Function	Hoist Type	Speed vs Weight	2-part				4-part				Motor (hp)	Motor (kW)
			1st Gear	2nd Gear	3rd Gear	4th Gear	1st Gear	2nd Gear	3rd Gear	4th Gear		
Hoist	20 LVF 15	ft/min lbs	86 6,614	138 3,968	171 3,086	224 1,543	43 13,228	69 7,937	86 6,173	112 3,086	20	15
	25 PC 15	ft/min lbs	28 6,614	111 6,614	221 3,307		14 13,228	56 13,228	111 6,614		25	18
Trolley	5 DVF 5	ft/min	30 - 73 - 191 (6,614 lbs)				30 - 73 - 145 (13,228 lbs)				6.5	4.8
Swing	RVF2-61	rpm	0.8								8.0	5.9

Power Requirements: 480 V (+6% or -10%) 60 Hz measured at turn table.
Amperage: 20 LVF 15: 43 Amp (3 phase service with ground)
Amperage: 25 PC 15: 51 Amp (3 phase service with ground)

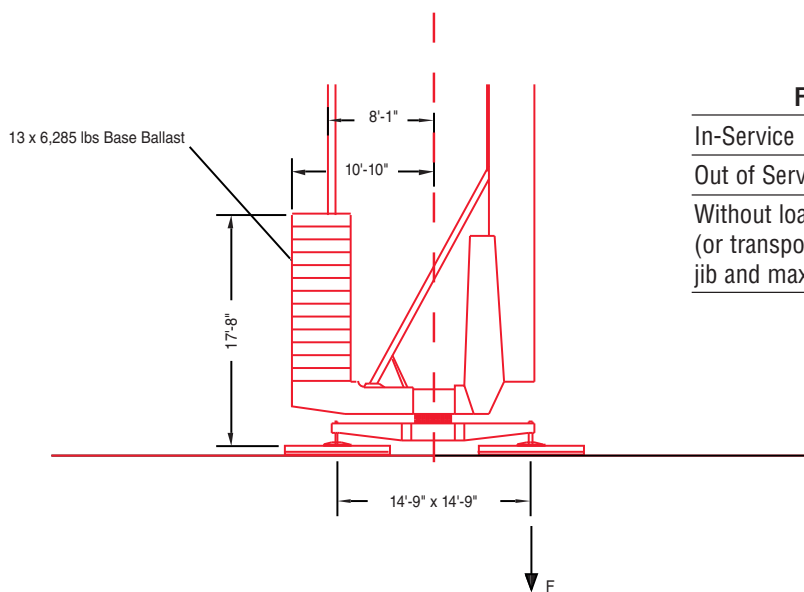

F = Maximum Corner Force

In-Service	88,185 lbs.
Out of Service	94,799 lbs.
Without load, ballast (or transport axles), with jib and maximum height	51,600 lbs.

Warning Systems

Limit Moment Cut-Out – Prevents a moment that is more than +10%.

HDT80

Warning

1. The operator must read and understand the owner's manual before operating this crane.
2. Positioning or operation of crane beyond areas shown is not intended or approved except where specified in owner's manual.
3. Practical working loads depend on supporting surface, wind, and other factors affecting stability such as hazardous surroundings, experience of personnel, and proper handling, all of which must be taken into account by the operator.

POTAIN



CraneCARE

CraneCARE is Manitowoc's complete service and support program. Incorporated into this program are service training, immediate parts availability, professional field service, and technical support and documentation. CraneCARE is available for every one of the thousands of cranes operating all over the world.

That's dedication and devotion that you won't get anywhere else.

That's **CraneCARE**.

Service Training

A certified Manitowoc service specialist works with you in your training facility or in the field to ensure that you know how to achieve maximum performance, dependability, and years from your cranes.

A reputable Manitowoc Service technician comes to you to provide valuable training to all distributors on the crane's LMI system.

Parts Availability

Genuine Manitowoc replacement parts may be obtained through your MCG distributor on a regular basis.

Field Service

Factory-trained service experts are always ready to help maintain your crane's peak performance.

For a worldwide listing of dealer locations, please consult our website at: www.manitowoccranes.com.

Technical Support

Manitowoc's dealer network and factory personnel are available 24 hours a day, 7 days a week, 365 days a year to answer your technical questions and more. **7**

For a worldwide listing of dealer locations, please consult our website at: www.manitowoccranes.com.

Technical Documentation

Manitowoc boasts an extensive, easy-to-understand library of documentation.

A complete set of Operator's parts and service manuals are included with each crane.

Additional copies are available through your Authorized Manitowoc Distributor.

HDT80

POTAIN 



POTAIN

Manitowoc Crane Group - Americas

Manitowoc, Wisconsin Facility
 Tel: [Int + 001] 920 684 6621
 Fax: [Int + 001] 920 683 6277
 Shady Grove, Pennsylvania Facility
 Tel: [Int + 001] 717 597 8121
 Fax: [Int + 001] 717 597 4062

Manitowoc Crane Group - EMEA

Europe Middle East & Africa
 Tel: [Int + 33] (0) 4 72 18 20 20
 Fax: [Int + 33] (0) 4 72 18 20 00

Manitowoc Crane Group - UK

Europe Middle East & Africa (Parts & Service)
 Tel: [Int + 44] (0) 191 565-6281
 Fax: [Int + 44] (0) 191 564-0442

Manitowoc Crane Group - Germany

(Sales, Parts & Service)
 Tel: [Int + 49] (0) 2173 8909-0
 Fax: [Int + 49] (0) 2173 8909-20

Manitowoc Crane Group - France

France & Africa (Sales, Parts & Service)
 Tel: [Int + 33] (0) 1 303-13150
 Fax: [Int + 33] (0) 1 303-86085

Manitowoc Crane Group - Netherlands

(Sales, Parts & Service)
 Tel: [Int + 31] (0) 76 578 39 99
 Fax: [Int + 31] (0) 76 578 39 78

Manitowoc Crane Group - Italy

Italy & Southern Europe (Sales, Parts & Service)
 Tel: [Int + 39] (0) 331 49 33 11
 Fax: [Int + 39] (0) 331 49 33 30

Manitowoc Crane Group - Portugal

Portugal & Spain (Sales, Parts & Service)
 Tel: [Int + 351] (0) 22 968 08 89
 Fax: [Int + 351] (0) 22 968 08 97

Manitowoc Crane Group - Singapore

Asia/Pacific excl China (Sales, Parts & Service)
 Tel: [Int + 65] 6861-7133
 Fax: [Int + 65] 6862-4040 / 4142

Manitowoc Crane Group - Shanghai

China (Sales, Parts & Service)
 Tel: [Int + 86] (0) 21-64955555
 Fax: [Int + 86] (0) 21-64852038

Manitowoc Crane Group - Beijing

China (Sales, Parts & Service)
 Tel: [Int + 86] (0) 10 646-71690
 Fax: [Int + 86] (0) 10 646-71691

Manitowoc Crane Group - Middle East

(Sales)
 Tel: [Int + 971] (0) 4 348-4478
 Fax: [Int + 971] (0) 4 348-4478
 (Parts & Service)
 Tel: [Int + 973] (0) 9 660-899
 Fax: [Int + 973] (0) 2 707-740

Distributed By:



www.manitowoccrane.com



Constant improvement and engineering progress make it necessary that we reserve the right to make specification, equipment, and price changes without notice. Illustrations shown may include optional equipment and accessories, and may not include all standard equipment.

