

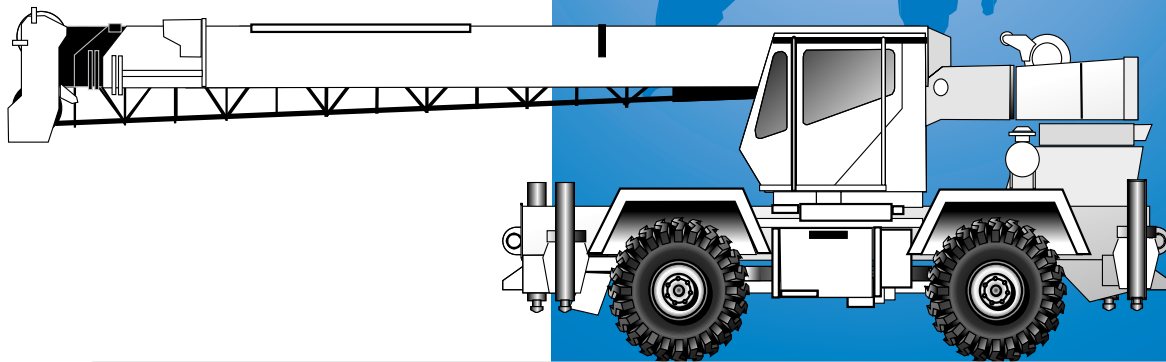

RT500C



Rough Terrain Hydraulic Crane



Dimensions

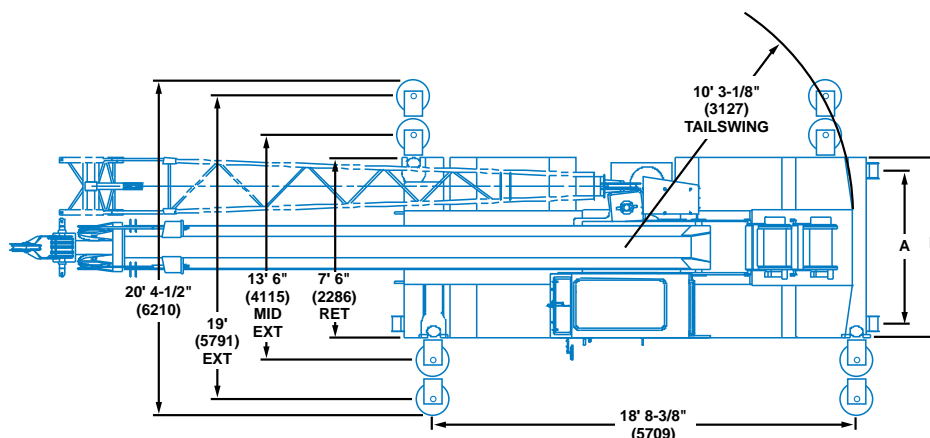

TIRE SIZE	16.00 x 25	20.5 x 25
A (TRACK)	6' 5-1/2" (1969)	6' 9-1/8" (2061)
B (OAW)	8' (2438)	8' 9" (2667)
GROUND CLEARANCE	1' 7-1/8" (486)	

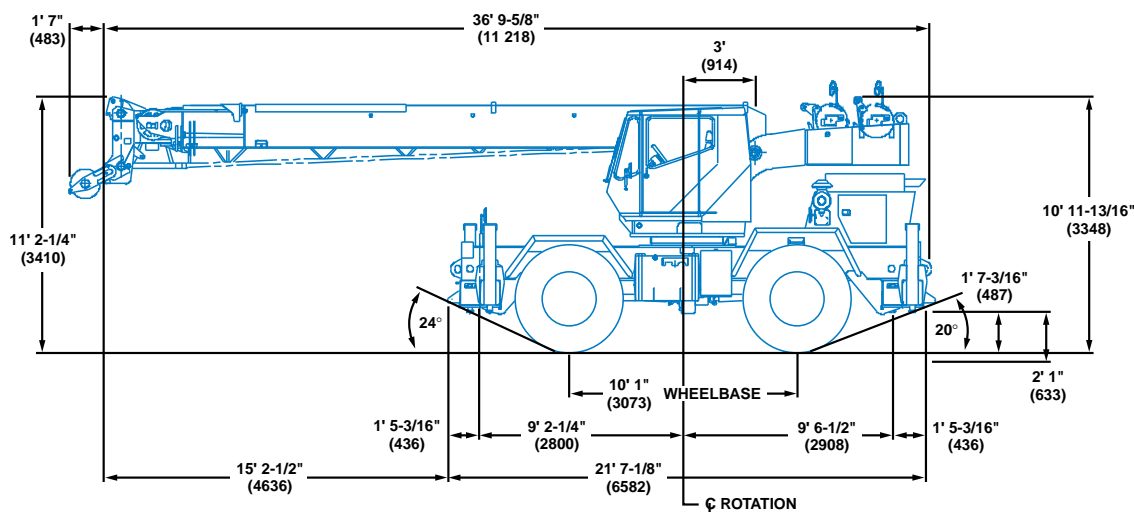

Note: () Reference dimensions in mm

Turning Radius 17' 0" (5182 mm)

Front Axle Load 23,959 lbs. (10 868 kg)

Rear Axle Load 29,094 lbs. (13 197 kg)

Gross Vehicle Weight 53,053 lbs. (24 065 kg)



Working range

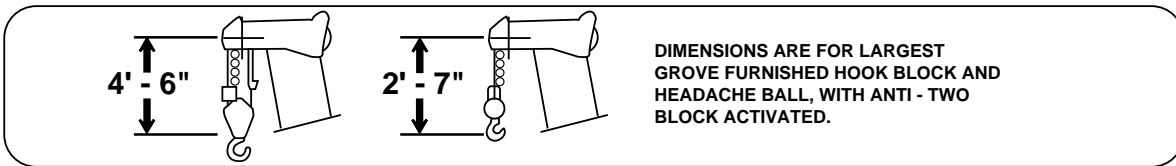
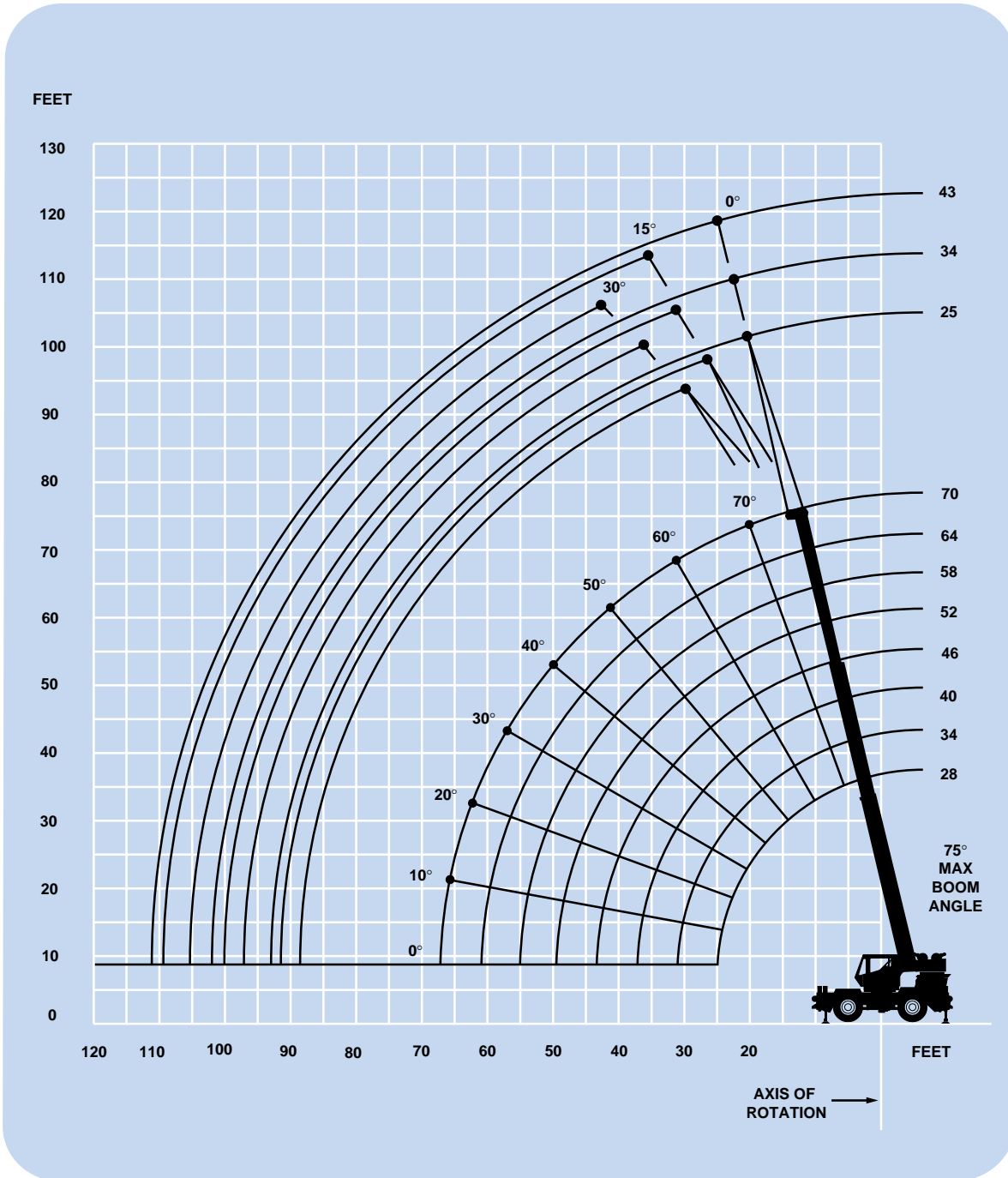

Superstructure specifications

Boom

28 ft. - 70 ft. (8.5 m - 21.3 m) three-section, full power boom. Maximum tip height: 76 ft. (23.1 m).

*Optional Jib

23 ft. (7.1 m) "A" frame jib offsettable at 0°, 15° or 30°. Stows beneath base boom section. Maximum tip height: 98 ft. (29.9 m).

*Optional Swingaway Extension

25 ft. (7.6 m) lattice swingaway boom extension. Stows alongside base boom section. Maximum tip height: 102 ft. (31.0 m).

*Optional Telescopic Swingaway Extension

25 ft. to 34 ft. or 43 ft. (7.6 m to 10.4 m or 13.1 m) telescoping lattice swingaway extension with integral offset mechanism, offsettable at 0°, 15° or 30°. Stows alongside base boom section. Maximum tip height: 120 ft. (36.6 m).

Boom Nose

Four steel sheaves mounted on heavy duty tapered roller bearings with removable pin-type rope guards. *Optional removable auxiliary boom nose with removable pin type rope guard.

Boom Elevation

Two double acting hydraulic cylinders with integral holding valves provide elevation from 0° to 75°.

Load Moment & Anti-Two Block System

Standard load moment and anti-two block system with audio-visual warning and control lever lockout. These systems provide electronic display of boom angle, length, radius, tip height, relative load moment, maximum permissible load, load indication and warning of impending two-block condition.

Cab

Full vision, all steel fabricated with acoustical lining and tinted safety glass throughout. Deluxe seat incorporates armrest mounted hydraulic single-axis controllers. Dash panel incorporates gauges for all engine functions. Other standard features include: telescoping tilt steering wheel, sliding side and rear windows, electric windshield wash/wipe, circulating air fan, manual skylight wiper, fire extinguisher, seat belt and ashtray.

Swing

Ball bearing swing circle with 360° continuous rotation. Grove planetary glide-swing with multi-disc wet brake. Spring applied, hydraulically released parking brake and plunger-type, one position, mechanical house lock and 360° positive swing lock operated from cab. Maximum speed: 2.5 RPM.

Counterweight

Removable, bolted to turntable mast. Main hoist: 10,170 lbs. (4613 kg). Main and Auxiliary hoist: 9,120 lbs. (4136 kg).

Hydraulic System

3 main gear pumps with a combined capacity of 112.5 GPM (426 LPM) driven by carrier engine through P.T.O. *Optional pump disconnect with engine jogging switch. Maximum operating pressure: 2500 PSI (172.4 bar).

Hoist Specifications

Main or *Auxiliary Hoist

Power up and down equal speed, grooved drum, planetary reduction with automatic spring applied multi-disc brake, hoist drum rotation indicators, cable followers.

Maximum Single Line Speed:	429 FPM (131 m/min)
Maximum Single Line Pull (1st Layer):	9,640 lbs. (4372 kg)
Maximum Permissible Line Pull w/5:1 Strength Factor:	9,080 lbs. (4119 kg) 5/8 in. (16 mm) 18 x 19 class
Maximum Rope Stowage:	375 ft. (114 m) 5/8 in. (16 m)

**Denotes optional equipment*



Carrier specifications

Chassis

High strength alloy steel, all welded box section design with integral outrigger housings and front/rear lifting, towing and tie down lugs.

Outrigger System

Four hydraulic, telescoping, single-stage, double box beam outriggers with inverted jacks and integral holding valves. Three position setting. All steel fabricated, quick release type square outrigger floats, 16.5 in. (419 mm) diameter. Maximum outrigger pad load: 50,254 lbs. (22 795 kg).

Outrigger Controls

Controls and crane level indicator located in cab.

Engine

Cummins 6BT 5.9 L, six cylinder, turbocharged, water cooled diesel. 130 bhp (97 kW) (Gross) @ 2,500 RPM. Maximum torque: 386 ft. lbs. (523 Nm) @ 1,400 RPM.

Fuel Tank Capacity

60 gallons (227 L)

Transmission

Remote mounted powershift with 6 forward and 6 reverse speeds. 3 in high range, 3 in low range. Rear axle disconnect for 4 x 2 travel.

Electrical System

Two 12 V - maintenance free batteries, 625 CCA @ 0° F. 12 V starting and lighting.

Drive

4 x 4.

Steering

Fully independent power steering:

Front: Full hydraulic steering wheel controlled.

Rear: Full hydraulic hand lever controlled.

Provides infinite variations of 4 main steering modes: front only, rear only, crab and coordinated.

Axles

Front: Drive/steer with differential and planetary reduction hubs rigid mounted to chassis.

Rear: Drive/steer with differential and planetary reduction hubs pivot mounted at the center of chassis providing up to 12 in. (305 mm) oscillation.

*Optional: No spin differential on rear axle.

Oscillation Lockouts

Automatic full hydraulic lockouts on rear axle permit oscillation only with boom centered over the front. *Optional oscillation lockout override control.

Brakes

Dual braking system, air over hydraulic operating on all wheels. Spring-applied, air released front axle mounted parking brake.

Tires

20.5 x 25 - 24PR earthmover type, tubeless.
*16.00 x 25 - 28PR earthmover type, tubeless.

Lights

Full lighting package including turn indicators, head, tail, brake and hazard warning lights.

Maximum Speed

22.8 MPH (36.7 kph).

Gradeability (Theoretical)

110.5% (Based on 51,610 lbs. [23 410 kg] GVW) 20.5 x 25 tires, pumps disengaged, 70 ft. (21.3 m) boom.

Miscellaneous Standard Equipment

Full width steel fenders, dual rear view mirrors, hookblock tiedown sling, electronic back-up alarm, light package, front stowage well, control valve for auxiliary hoist, 360° positive swing lock.

*Optional Equipment

*Auxiliary hoist	*Spare wheel assembly
*Boom mounted worklights	*Tire inflation kit
*360° flashing light	*Tool kit
*Cab spotlight	*Pintle hook front/rear
*Tachometer	*High speed glide system
*Cold start aid (less canister)	*Propane or diesel heater/defroster
*Engine block heater	*Air conditioning
*Electric skylight wiper, with opening skylight	*Dual axis joystick controllers
*Hookblocks	*Hydraulic oil cab heater
*Tow winch - front mounted maximum pull: 15,000 lbs. (6804 kg); maximum speed: 75 ft./min. (23 m/min).	*Headache ball
	*Emergency steer pump
	*LMI light bar

*Denotes optional equipment



28 - 70 ft.
(8.5 - 21.3 m)



10,170 lbs.
(4613 kg)



100%



360°



Pounds

Feet	28	34	40	46	52	58	64	70	
10	56,000 (64)	36,000 (69)	36,000 (73)						
12	40,000 (59.5)	36,000 (65.5)	36,000 (70)	35,000 (73)					
15	31,000 (51.5)	31,000 (59.5)	30,950 (65)	30,300 (69)	29,750 (72)	29,150 (74.5)			
20	23,200 (36.5)	23,200 (49)	23,200 (57)	23,200 (62)	23,000 (66)	22,600 (69.5)	22,250 (72)	20,500 (74)	
25	17,950 (6)	17,950 (36)	17,950 (47.5)	17,950 (54.5)	17,950 (60)	17,950 (64)	17,950 (67)	17,650 (69.5)	
30		15,350 (15.5)	15,350 (36.5)	15,350 (46.5)	15,350 (53)	15,150 (58)	14,950 (62)	14,750 (65)	
35			12,850 (20)	12,850 (36.5)	12,850 (45.5)	12,800 (51.5)	12,650 (56.5)	12,500 (60)	
40				10,750 (23)	10,750 (36.5)	10,750 (45)	10,750 (50.5)	10,750 (55)	
45					9,020 (25)	9,020 (37)	9,020 (44.5)	9,020 (49.5)	
50						7,420 (26.5)	7,420 (37)	7,420 (43.5)	
55						6,170 (3.5)	6,170 (28)	6,170 (37)	
60							5,170 (13)	5,170 (28.5)	
65								4,350 (15.5)	
Minimum boom angle (deg.) for indicated length (no load)									0
Maximum boom length (ft.) at 0 degree boom angle (no load)									70

NOTE: () Boom angles are in degrees.

A6-829-008639 & -003716H

Boom Angle	28	34	40	46	52	58	64	70
0°	15,286 (25.1)	12,000 (31)	9,230 (37)	7,050 (43)	5,630 (49)	4,440 (55)	3,480 (61)	2,800 (66.6)

NOTE: () Reference radii are in feet.

A6-829-009460

THIS CHART IS ONLY A GUIDE AND SHOULD NOT BE USED TO OPERATE THE CRANE. The individual crane's load chart, operating instructions and other instructional plates must be read and understood prior to operating the crane.





28 - 70 ft.
(8.5 - 21.3 m)



10,170 lbs.
(4613 kg)



50%
13' 5" Spread



360°



Pounds

Feet	28	34	40	46	52	58	64	70
10	49,200 (64)	36,000 (69)	36,000 (73)					
12	40,000 (59.5)	36,000 (65.5)	36,000 (70)	35,000 (73)				
15	31,000 (51.5)	31,000 (59.5)	30,950 (65)	30,300 (69)	29,750 (72)	29,150 (74.5)		
20	23,200 (36.5)	23,200 (49)	23,000 (57)	22,500 (62)	22,000 (66)	21,500 (69.5)	21,050 (72)	20,500 (74)
25	15,200 (6)	15,200 (36)	15,200 (47.5)	15,200 (54.5)	15,200 (60)	15,200 (64)	15,200 (67)	15,150 (69.5)
30		11,150 (15.5)	11,150 (36.5)	11,150 (46.5)	11,150 (53)	11,150 (58)	11,150 (62)	11,150 (65)
35			8,520 (20)	8,520 (36.5)	8,520 (45.5)	8,520 (51.5)	8,520 (56.5)	8,520 (60)
40				6,680 (23)	6,680 (36.5)	6,680 (45)	6,680 (50.5)	6,680 (55)
45					5,320 (25)	5,320 (37)	5,320 (44.5)	5,320 (49.5)
50						4,270 (26.5)	4,270 (37)	4,270 (43.5)
55						3,440 (3.5)	3,440 (28)	3,440 (37)
60							2,770 (13)	2,770 (28.5)
65								2,210 (15.5)
Minimum boom angle (deg.) for indicated length (no load)								0
Maximum boom length (ft.) at 0 degree boom angle (no load)								70

NOTE: () Boom angles are in degrees.

Boom Angle	28	34	40	46	52	58	64	70
0°	15,150 (25.1)	10,500 (31)	7,720 (37)	5,810 (43)	4,460 (49)	3,440 (55)	2,650 (61)	2,050 (66.6)

NOTE: () Reference radii in feet.

A6-829-012237

THIS CHART IS ONLY A GUIDE AND SHOULD NOT BE USED TO OPERATE THE CRANE. The individual crane's load chart, operating instructions and other instructional plates must be read and understood prior to operating the crane.

RT500C

7





28 - 70 ft.
(8.5 - 21.3 m)



10,170 lbs.
(4613 kg)



0%
7' 5" Spread



360°



Pounds

Feet	28	34	40	46	52	58	64	70
10	28,700 (64)	28,700 (69)	28,050 (73)					
12	20,950 (59.5)	20,950 (65.5)	20,950 (70)	20,950 (73)				
15	14,450 (51.5)	14,450 (59.5)	14,450 (65)	14,450 (69)	14,450 (72)	14,450 (74.5)		
20	9,020 (36.5)	9,020 (49)	9,020 (57)	9,020 (62)	9,020 (66)	9,020 (69.5)	9,020 (72)	9,020 (74)
25	6,120 (6)	6,120 (36)	6,120 (47.5)	6,120 (54.5)	6,120 (60)	6,120 (64)	6,120 (67)	6,120 (69.5)
30		4,330 (15.5)	4,330 (36.5)	4,330 (46.5)	4,330 (53)	4,330 (58)	4,330 (62)	4,330 (65)
35			3,110 (20)	3,110 (36.5)	3,110 (45.5)	3,110 (51.5)	3,110 (56.5)	3,110 (60)
40				2,230 (23)	2,230 (36.5)	2,230 (45)	2,230 (50.5)	2,230 (55)
45					1,560 (25)	1,560 (37)	1,560 (44.5)	1,560 (49.5)
50						1,030 (26.5)	1,030 (37)	1,030 (43.5)
Minimum boom angle (deg.) for indicated length (no load)								40.5
Maximum boom length (ft.) at 0 degree boom angle (no load)								52

NOTE: () Boom angles are in degrees.

Boom Angle	28	34	40	46	52
0°	6,090 (25.1)	4,050 (31)	2,720 (37)	1,800 (43)	1,130 (49)

NOTE: () Reference radii in feet.

A6-829-012238

THIS CHART IS ONLY A GUIDE AND SHOULD NOT BE USED TO OPERATE THE CRANE. The individual crane's load chart, operating instructions and other instructional plates must be read and understood prior to operating the crane.



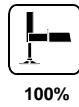
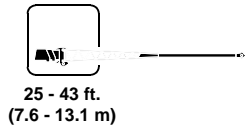

Feet	25 ft. LENGTH			34 ft. LENGTH			43 ft. LENGTH		
	0° OFFSET	15° OFFSET	30° OFFSET	0° OFFSET	15° OFFSET	30° OFFSET	0° OFFSET	15° OFFSET	30° OFFSET
25	*12,500 (75)	*7,300 (75)		*7,700 (75)			*4,500 (75)		
30	10,700 (71.5)	7,170 (74)	*5,250 (75)	7,180 (73)	*4,900 (75)		4,430 (74)		
35	9,230 (68)	6,490 (70.5)	5,080 (73)	6,110 (70)	4,790 (73.5)		3,960 (71.5)	*2,800 (75)	
40	8,280 (65)	5,900 (67.5)	4,730 (69.5)	5,370 (67)	4,360 (70.5)	*3,200 (75)	3,610 (68.5)	2,770 (74)	
45	7,340 (61.5)	5,460 (64)	4,440 (66)	4,870 (63.5)	4,020 (67.5)	2,900 (71.5)	3,360 (66)	2,640 (71)	*2,200 (75)
50	6,720 (58)	5,210 (60.5)	4,270 (62.5)	4,500 (60)	3,730 (64.5)	2,590 (68)	3,140 (63.5)	2,520 (68.5)	2,150 (73)
55	6,430 (54)	5,030 (56.5)	4,130 (58.5)	4,070 (56.5)	3,400 (61.5)	2,360 (64.5)	2,920 (60.5)	2,400 (65.5)	2,080 (69.5)
60	5,510 (50)	4,970 (53)	3,980 (54.5)	3,700 (53)	3,100 (58)	2,220 (61)	2,730 (57.5)	2,280 (62.5)	2,020 (66.5)
65	4,630 (46)	4,630 (48.5)	3,900 (50)	3,450 (49.5)	2,830 (54.5)	2,070 (57)	2,560 (54.5)	2,170 (59)	1,950 (63)
70	3,890 (41.5)	3,890 (44)	3,800 (45.5)	3,310 (45.5)	2,610 (50.5)	1,940 (53)	2,360 (51.5)	2,110 (56)	1,880 (59.5)
75	3,270 (36.5)	3,270 (39)	3,270 (40)	3,170 (41)	2,470 (46.5)	1,880 (48.5)	2,210 (48)	2,040 (52.5)	1,810 (56)
80	2,730 (30.5)	2,730 (33)	2,730 (34)	3,080 (36.5)	2,410 (42)	1,830 (44)	2,140 (44.5)	1,980 (49)	1,730 (52)
85	2,270 (23.5)	2,270 (26)		2,740 (31.5)	2,370 (37)	1,790 (38.5)	2,100 (41)	1,940 (45)	1,670 (47.5)
90	1,860 (12.5)			2,320 (25.5)	2,310 (31.5)	1,770 (32)	2,060 (36.5)	1,900 (40.5)	1,620 (43)
95				1,950 (18.5)	1,950 (24)		2,010 (32)	1,850 (35.5)	1,570 (37.5)
100							1,940 (26.5)	1,780 (30)	1,500 (30.5)
105							1,690 (19)	1,690 (22)	

NOTE: () Boom angles are in degrees.
*This capacity is based upon maximum boom angle.

A6-829-008672

THIS CHART IS ONLY A GUIDE AND SHOULD NOT BE USED TO OPERATE THE CRANE. The individual crane's load chart, operating instructions and other instructional plates must be read and understood prior to operating the crane.

RT500C

9

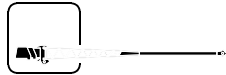

25 - 43 ft.
(7.6 - 13.1 m)



10,170 lbs.
(4613 kg)



50%
13' 5" Spread



360°



Feet	25 ft. LENGTH			34 ft. LENGTH			43 ft. LENGTH		
	0° OFFSET	15° OFFSET	30° OFFSET	0° OFFSET	15° OFFSET	30° OFFSET	0° OFFSET	15° OFFSET	30° OFFSET
25	*12,500 (75)	*7,300 (75)		*7,700 (75)			*4,500 (75)		
30	10,700 (71.5)	7,170 (74)	*5,250 (75)	7,180 (73)	*4,900 (75)		4,430 (74)		
35	9,230 (68)	6,490 (70.5)	5,080 (73)	6,110 (70)	4,790 (73.5)		3,960 (71.5)	*2,800 (75)	
40	7,370 (65)	5,900 (67.5)	4,730 (69.5)	5,370 (67)	4,360 (70.5)	*3,200 (75)	3,610 (68.5)	2,770 (74)	
45	5,850 (61.5)	5,460 (64)	4,440 (66)	4,870 (63.5)	4,020 (67.5)	2,900 (71.5)	3,360 (66)	2,640 (71)	*2,200 (75)
50	4,670 (58)	4,670 (60.5)	4,270 (62.5)	4,500 (60)	3,730 (64.5)	2,590 (68)	3,140 (63.5)	2,520 (68.5)	2,150 (73)
55	3,740 (54)	3,740 (56.5)	3,740 (58.5)	4,070 (56.5)	3,400 (61.5)	2,360 (64.5)	2,920 (60.5)	2,400 (65.5)	2,080 (69.5)
60	2,990 (50)	2,990 (53)	2,990 (54.5)	3,510 (53)	3,100 (58)	2,220 (61)	2,730 (57.5)	2,280 (62.5)	2,020 (66.5)
65	2,360 (46)	2,360 (48.5)	2,360 (50)	2,870 (49.5)	2,830 (54.5)	2,070 (57)	2,560 (54.5)	2,170 (59)	1,950 (63)
70	1,840 (41.5)	1,840 (44)	1,840 (45.5)	2,330 (45.5)	2,330 (50.5)	1,940 (53)	2,360 (51.5)	2,110 (56)	1,880 (59.5)
75	1,390 (36.5)	1,390 (39)	1,390 (40)	1,860 (41)	1,860 (46.5)	1,860 (48.5)	2,050 (48)	2,040 (52.5)	1,810 (56)
80	1,000 (30.5)	1,000 (33)	1,000 (34)	1,460 (36.5)	1,460 (42)	1,460 (44)	1,690 (44.5)	1,690 (49)	1,690 (52)
85				1,120 (31.5)	1,120 (37)	1,120 (38.5)	1,370 (41)	1,370 (45)	1,370 (47.5)
90							1,090 (36.5)	1,090 (40.5)	1,090 (43)

NOTE: () Boom angles are in degrees.
*This capacity is based upon maximum boom angle.

A6-829-012453

THIS CHART IS ONLY A GUIDE AND SHOULD NOT BE USED TO OPERATE THE CRANE. The individual crane's load chart, operating instructions and other instructional plates must be read and understood prior to operating the crane.





25 ft.
(7.6 m)



10,170 lbs.
(4613 kg)



100%



360°



Feet

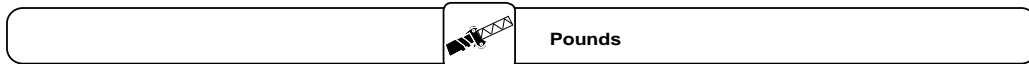

Pounds

BOOM ANGLE (Ref.)

CAPACITY (lbs.)

Feet	BOOM ANGLE (Ref.)	CAPACITY (lbs.)
25	75.0	*12,500
30	71.5	10,700
35	68.0	9,230
40	65.0	8,280
45	61.5	7,340
50	58.0	6,720
55	54.0	6,430
60	50.0	6,070
65	46.0	5,180
70	41.5	4,440
75	36.5	3,820
80	30.5	3,280
85	23.5	2,810
90	12.5	2,400

*This capacity is based upon maximum boom angle.

A6-829-008673



25 ft.
(7.6 m)



10,170 lbs.
(4613 kg)



50%
13' 5" Spread



360°



Feet

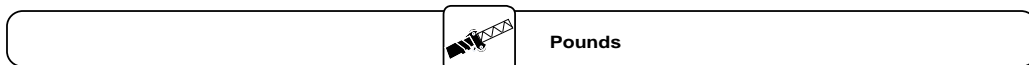

Pounds

BOOM ANGLE (Ref.)

CAPACITY (lbs.)

Feet	BOOM ANGLE (Ref.)	CAPACITY (lbs.)
25	75.0	*12,500
30	71.5	10,700
35	68.0	9,230
40	65.0	7,760
45	61.5	6,380
50	58.0	5,200
55	54.0	4,270
60	50.0	3,520
65	46.0	2,890
70	41.5	2,360
75	36.5	1,910
80	30.5	1,530
85	23.5	1,190

*This capacity is based upon maximum boom angle.

A6-829-012329

THIS CHART IS ONLY A GUIDE AND SHOULD NOT BE USED TO OPERATE THE CRANE. The individual crane's load chart, operating instructions and other instructional plates must be read and understood prior to operating the crane.

RT500C

11



28 -70 ft.
(8.5 - 21.3 m)



10,170 lbs.
(4613 kg)



20.5 x 25
24 Ply
Stationary



360°



Pounds

Feet	28	34	40	46	52	58	64	70
10	26,200 (64)	26,200 (69)						
12	19,350 (59.5)	19,350 (65.5)	16,000 (70)					
15	13,200 (51.5)	13,200 (59.5)	13,200 (65)	13,200 (69)				
20	7,910 (36.5)	7,910 (49)	7,910 (57)	7,910 (62)	7,910 (66)	7,400 (69.5)		
25	5,060 (6)	5,060 (36)	5,060 (47.5)	5,060 (54.5)	5,060 (60)	5,060 (64)	5,060 (67)	5,060 (69.5)
30		3,600 (15.5)	3,600 (36.5)	3,600 (46.5)	3,600 (53)	3,600 (58)	3,600 (62)	3,600 (65)
35			2,610 (20)	2,610 (36.5)	2,610 (45.5)	2,610 (51.5)	2,610 (56.5)	2,610 (60)
40				1,890 (23)	1,890 (36.5)	1,890 (45)	1,890 (50.5)	1,890 (55)
45					1,340 (25)	1,340 (37)	1,340 (44.5)	1,340 (49.5)
50						910 (26.5)	910 (37)	910 (43.5)

NOTE: () Boom angles are in degrees.

A6-829-009074

Boom Angle	28	34	40	46
0°	5,030 (25.1)	3,360 (31)	2,300 (37)	1,540 (43)

NOTE: () Reference radii are in feet.

A6-829-009460

THIS CHART IS ONLY A GUIDE AND SHOULD NOT BE USED TO OPERATE THE CRANE. The individual crane's load chart, operating instructions and other instructional plates must be read and understood prior to operating the crane.





28 - 70 ft.
(8.5 - 21.3 m)



10,170 lbs.
(4613 kg)



20.5 x 25
24 Ply
Stationary



Defined Arc
Over Front
±6°



Pounds

Feet	28	34	40	46	52	58	64	70
10	28,650 (64)	26,200 (69)						
12	24,950 (59.5)	24,950 (65.5)	21,000 (70)					
15	20,900 (51.5)	20,900 (59.5)	20,900 (65)	16,500 (69)				
20	14,900 (36.5)	14,900 (49)	14,900 (57)	12,200 (62)	12,200 (66)	12,200 (69.5)		
25	9,900 (6)	9,900 (36)	9,900 (47.5)	9,900 (54.5)	9,400 (60)	9,400 (64)	9,400 (67)	9,400 (69.5)
30		7,350 (15.5)	7,350 (36.5)	7,350 (46.5)	7,000 (53)	7,000 (58)	7,000 (62)	7,000 (65)
35			5,660 (20)	5,660 (36.5)	5,660 (45.5)	5,600 (51.5)	5,600 (56.5)	5,600 (60)
40				4,450 (23)	4,450 (36.5)	4,450 (45)	4,450 (50.5)	4,450 (55)
45					3,550 (25)	3,550 (37)	3,550 (44.5)	3,550 (49.5)
50						2,850 (26.5)	2,850 (37)	2,850 (43.5)
55						2,290 (3.5)	2,290 (28)	2,290 (37)
60							1,840 (13)	1,840 (28.5)
65								1,460 (15.5)

NOTE: () Boom angles are in degrees.

A6-829-009073A

Boom Angle	28	34	40	46	52	58	64	70
0°	9,860 (25.1)	6,940 (31)	5,130 (37)	3,880 (43)	2,980 (49)	2,290 (55)	1,760 (61)	1,350 (66.6)

NOTE: () Reference radii are in feet.

A6-829-009460

THIS CHART IS ONLY A GUIDE AND SHOULD NOT BE USED TO OPERATE THE CRANE. The individual crane's load chart, operating instructions and other instructional plates must be read and understood prior to operating the crane.

RT500C

13





28 -70 ft.
(8.5 - 21.3 m)



10,170 lbs.
(4613 kg)



20.5 x 25 - 24 Ply
Pick & Carry
(Up to 2.5 MPH)



Boom Centered
Over Front



Pounds

Feet	28	34	40	46	52	58	64	70
10	33,800 (64)							
12	29,000 (59.5)							
15	23,600 (51.5)	23,600 (59.5)	23,600 (65)	23,600 (69)				
20	14,900 (36.5)	14,900 (49)	14,900 (57)	14,900 (62)	12,200 (66)	12,200 (69.5)		
25	9,900 (6)	9,900 (36)	9,900 (47.5)	9,900 (54.5)	9,900 (60)	9,400 (64)	9,400 (67)	
30		7,180 (15.5)	7,180 (36.5)	7,180 (46.5)	7,180 (53)	7,180 (58)	7,000 (62)	7,000 (65)
35			5,660 (20)	5,660 (36.5)	5,660 (45.5)	5,660 (51.5)	5,660 (56.5)	5,600 (60)
40				4,450 (23)	4,450 (36.5)	4,450 (45)	4,450 (50.5)	4,450 (55)
45					3,550 (25)	3,550 (37)	3,550 (44.5)	3,550 (49.5)
50						2,850 (26.5)	2,850 (37)	2,850 (43.5)
55						2,290 (3.5)	2,290 (28)	2,290 (37)
60							1,840 (13)	1,840 (28.5)
65								1,460 (15.5)

NOTE: () Boom angles are in degrees.

A6-829-009075

Boom Angle	28	34	40	46	52	58	64	70
0°	8,970 (25.1)	6,870 (31)	5,130 (37)	3,880 (43)	2,980 (49)	2,290 (55)	1,760 (61)	1,350 (66.6)

NOTE: () Reference radii are in feet.

A6-829-009460

THIS CHART IS ONLY A GUIDE AND SHOULD NOT BE USED TO OPERATE THE CRANE. The individual crane's load chart, operating instructions and other instructional plates must be read and understood prior to operating the crane.



Working range

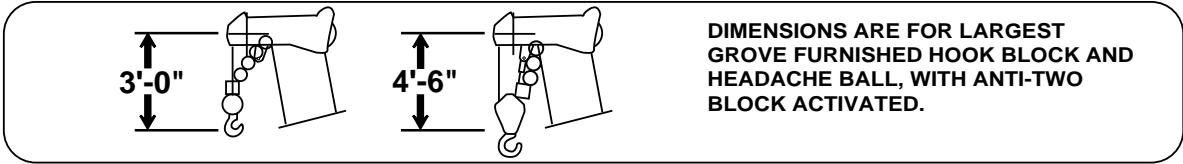
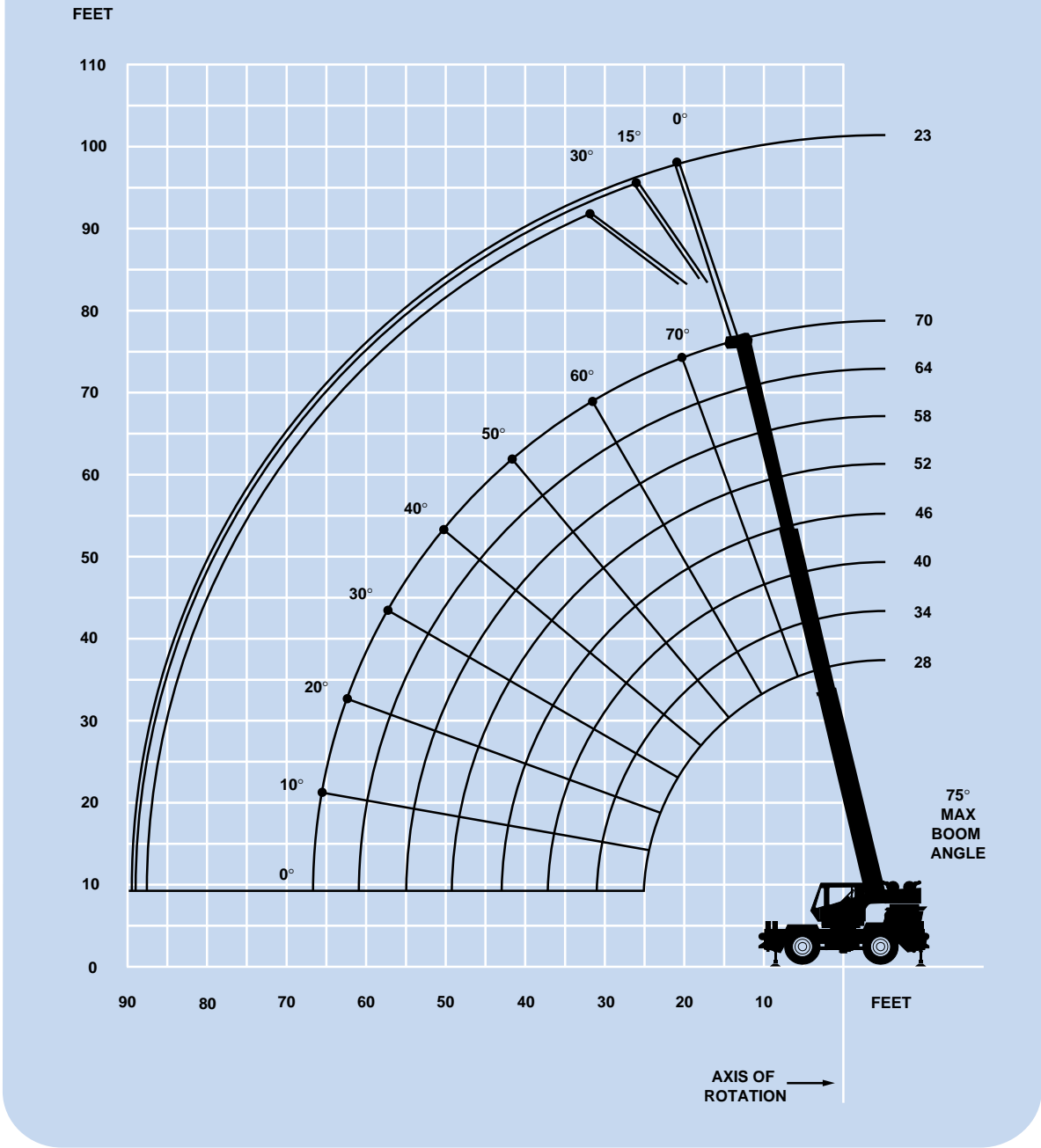
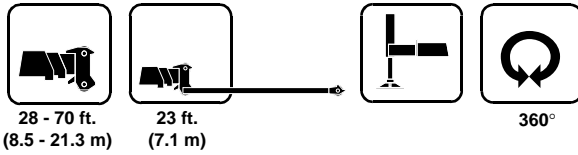

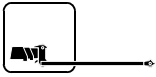

23 ft.
(7.1 m)



10,170 lbs.
(4613 kg)



100%



360°

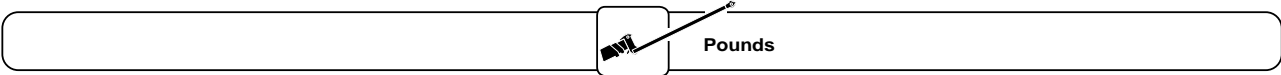

Main Boom Angle	0° OFFSET	15° OFFSET	30° OFFSET
	Cap. in lbs. (Rad. Ref)	Cap. in lbs. (Rad. Ref)	Cap. in lbs. (Rad. Ref)
75	12,000 (27)	7,700 (32.5)	5,070 (35.7)
70	10,400 (33.3)	7,000 (38.1)	4,800 (41.2)
65	8,500 (40.2)	6,300 (44.9)	4,500 (47.8)
60	7,400 (47)	5,450 (51.3)	4,300 (54)
55	6,600 (53.2)	5,000 (57.3)	4,100 (59.8)
50	6,100 (59.2)	4,700 (62.9)	3,900 (65.1)
45	5,160 (64.7)	4,500 (68)	3,800 (69.9)
40	4,410 (69.6)	4,010 (72.6)	3,700 (74.2)
35	3,840 (74)	3,530 (76.6)	3,390 (77.9)
30	3,400 (77.8)	3,160 (80.1)	

NOTE: () Reference radii are in feet.

A6-829-008660

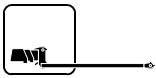

23 ft.
(7.1 m)



10,170 lbs.
(4613 kg)



50%
13' 5" Spread



360°

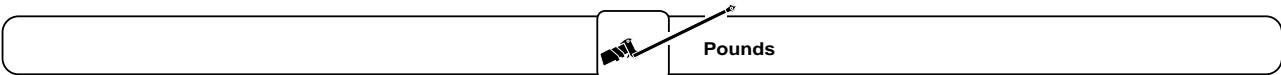

Main Boom Angle	0° OFFSET	15° OFFSET	30° OFFSET
	Cap. in lbs. (Rad. Ref)	Cap. in lbs. (Rad. Ref)	Cap. in lbs. (Rad. Ref)
75	12,000 (27)	7,700 (32.5)	5,070 (35.7)
70	10,050 (33.3)	7,000 (38.1)	4,800 (41.2)
65	7,580 (40.2)	6,300 (44.9)	4,500 (47.8)
60	5,850 (47)	4,950 (51.3)	4,300 (54)
55	4,610 (53.2)	3,950 (57.3)	3,600 (59.8)
50	3,680 (59.2)	3,210 (62.9)	2,950 (65.1)
45	3,000 (64.7)	2,650 (68)	2,460 (69.9)
40	2,490 (69.6)	2,220 (72.6)	2,090 (74.2)
35	2,100 (74)	1,890 (76.6)	1,790 (77.9)
30	1,800 (77.8)	1,640 (80.1)	

NOTE: () Reference radii are in feet.

A6-829-013238

THIS CHART IS ONLY A GUIDE AND SHOULD NOT BE USED TO OPERATE THE CRANE. The individual crane's load chart, operating instructions and other instructional plates must be read and understood prior to operating the crane.



Rated lifting capacities

NOTES FOR LIFTING CAPACITIES

WARNING: THIS CHART IS ONLY A GUIDE.
 The notes below are for illustration only and should not be relied upon to operate the crane. The individual crane's load chart, operating instructions and other instruction plates must be read and understood prior to operating the crane.

1. All rated loads meet ANSI/ASME B30.5 Mobile and Locomotive Cranes. Testing and development were performed to SAEJ1063, Cantilevered Boom Crane Structures, Method of Test and SAEJ765 Crane Stability Test Code.

2. Rated loads include the weight of hookblock, slings and auxiliary lifting devices and their weights shall be subtracted from the listed rating to obtain the net load to be lifted. When more than the minimum required hoist reeving is used, the additional rope weight shall be considered part of the load to be handled.

3. Capacities appearing above the bold line are based on structural strength. Tipping should never be relied upon as a capacity indication.



































4. The machine shall be leveled on a firm supporting surface. Depending on the nature of the supporting surface, it may be necessary to have structural supports under the outrigger floats or tires to spread the load to a larger bearing surface.

5. When either boom length or radius or both are between values listed, the smallest load shown at either the next larger radius or next longer or shorter boom length shall be used.

6. Tires shall be inflated to the recommended pressure before lifting on rubber.

7. For outrigger operation, outriggers shall be properly extended with tires raised free of crane weight before operating the boom or lifting loads.

Symbols Glossary

	Frame		Steering
	Outriggers		Transmission
	Outrigger Controls		Axles
	Engine		Brakes
	Fuel Tank Capacity		Tires
	Electrical System		Suspension
	Drive		Rotation
	Lights		Boom Elevation
	Cab		Swing
	Boom		Counterweight
	Fixed Swingaway		Oil
	Tele-Swingaway		Hydraulic System
	Jib		Hoist
	Boom Nose		Radius
	Boom Extension		Boom Length
	Speed		Hookblock
	Grade		Gear
	Lattice Extension		Luffing Jib

RT500C

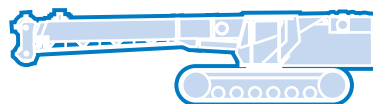
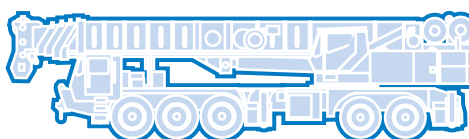
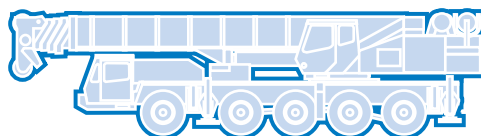
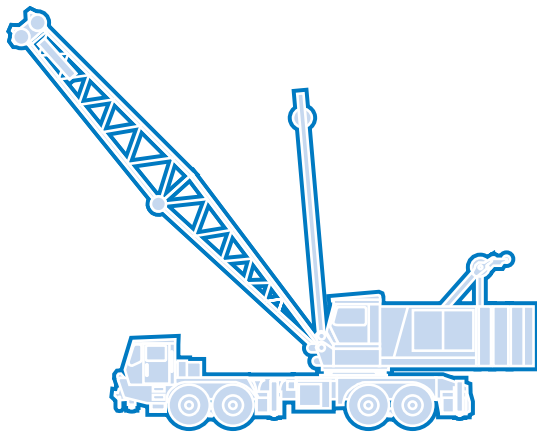

Grove Worldwide – World Headquarters

Grove North America
 1565 Buchanan Trail East
 P.O. Box 21
 Shady Grove, Pennsylvania 17256, U.S.A.
 Tel: [Int + 1] (717) 597-8121
 Fax: [Int + 1] (717) 597-4062
 Western Hemisphere, Asia/Pacific

Grove Europe Limited*

Sunderland SR4 6TT, England
 Tel: [Int + 44] 191 565-6281
 Fax: [Int + 44] 191 564-0442
 Europe, Africa, Middle East

Grove Europe Limited*

P.O. Box No. 268
 4A Kimber Road
 Abingdon, Oxfordshire, OX141SG
 Tel: [Int + 44] 1235 55-3184
 Fax: [Int + 44] 1235 55-3218
*Grove Europe Limited, Registered in England,
 Number 1845128, Registered office, Crown Works,
 Pallion, Sunderland, Tyne & Wear, England SR4 6TT

**Deutsche Grove GmbH
 Sales and Service**

Helmholtzstrasse 12, Postfach 5026
 D-40750 Langenfeld, Germany
 Tel: [Int + 49] (2173) 8909-0
 Fax: [Int + 49] (2173) 8909-30

Wilhelmshaven Works

Industriegelände West, Postfach 1853
 D-26358 Wilhelmshaven, Germany
 Tel: [Int + 49] (4421) 294-0
 Fax: [Int + 49] (4421) 294-301

Grove France S.A.

16, chaussée Jules-César, 95520 OSNY
 B.P. 203, 95523 CERGY PONTOISE CEDEX
 France
 Tel: [Int + 33] (1) 30313150
 Int: [Int + 33] (1) 30386085

Grove Asia/Pacific - Regional Office

171 Chin Swee Road
 #06-01 San Centre
 Singapore 0316
 Tel: [Int + 65] 536-6112
 Fax: [Int + 65] 536-6119
 Asia/Pacific, Near East

Grove China - Representative Office

Beijing Suite 6074
 No. 33 East Chang An Avenue
 Beijing, 100004, China
 Tel: [Int + 86] (10) 513-7766
 Fax: [Int + 86] (10) 513-7307

Grove Product Support

Western Hemisphere, Asia/Pacific
 1086 Wayne Avenue
 Chambersburg, Pennsylvania USA
 Tel: [Int + 1] (717) 263-5100
 Fax: [Int + 1] (717) 267-0404

Europe, Africa, Middle East
 Sunderland SR4 6TT, England
 Tel: [Int + 44] 191 565-6281
 Parts Fax: [Int + 44] 191 510-9242
 Service Fax: [Int + 44] 191 510-9560

<http://www.grovetworldwide.com>

Bigge Crane and Rigging Co.

10700 Bigge Avenue
 San Leandro, CA 94577
 Phone: (888) 337-BIGGE or (510) 638-8100
 Fax: (510) 639-4053
 Email: info@bigge.com
 Web site: www.bigge.com

Constant improvement and engineering progress make it necessary that we reserve the right to make specification, equipment, and price changes without notice. Illustrations shown may include optional equipment and accessories and may not include all standard equipment.

Distributed By:

Form No.: SBRT500C Part No.: 3-484 1197-10M Printed in U.S.A.

